

Asist®



CZ

NÁVOD K POUŽITÍ

PRACOVNÍ

SKLÁDACÍ

STŮL











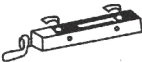

SK

NÁVOD NA POUŽITIE

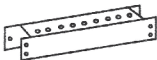
PRACOVNÍ

SKLÁDACÍ

STÔL

#1		PRACOVNÍ DESKA PRACOVNÁ DOSKA	2 KS
#2		ŠROUB DO DŘEVA SKRUTKA DO DREVA	16 KS
#3		DRŽÁK DESKY DRŽIAK DOSKY	2 KS
#4		M6 ŠROUB M6 SKRUTKA	8 KS
#5		PODLOŽKA 12x6MM PODLOŽKA 12x6MM	8 KS
#6		M6 MATICE M6 MATICA	8 KS
#7		VZPĚRA VZPERA	2 KS
#8		NOHY STOLU NOHY STOLA	2 KS
#9		PROTISKLUZNÁ PODLOŽKA PROTIŠMIKOVÁ PODLOŽKA	4 KS
#10		M6 ŠROUB M6 SKRUTKA	4 KS
#11		PODLOŽKA 12x6MM PODLOŽKA 12x6MM	4 KS
#12		M6 NYLON MATICE M6 NYLON MATICA	4 KS
#13		SVĚRKA SVORKA	4 KS

cz - NÁVOD K POUŽITÍ



[A]

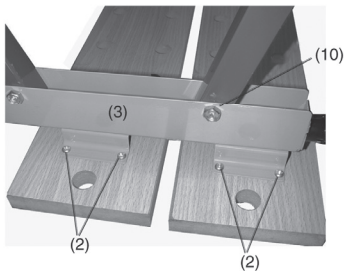

[B]

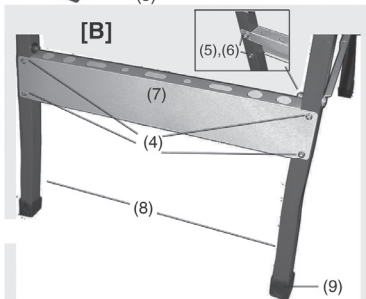

1. NEPOUŽÍVEJTE JAKO ŽEBŘÍK

2. ZATÍŽENÍ: MAX. 100 kg

3. POTŘEBNÉ NÁŘADÍ:

A. ŠROUBOVÁK (PHILLIPS 2 A 3)

B. KLADIVO

C. KLÍČ (OBSAŽENO V BALENÍ)

4. NÁVOD SE SEZNAMEM DÍLŮ
K IDENTIFIKACI DÍLŮ

Materiál:

**ocel (25mm čtvercový průřez) /
deska MDF**

Rozměry rozložený:

605×630×755mm

Rozměry složený:

605×150×920mm

Rozměry desky:

605×120×18mm

max. zatížení:

100kg

hrubá hmotnost:

5.6kg

čistá hmotnost:

5.2kg

SK - Návod na použitie



[A]

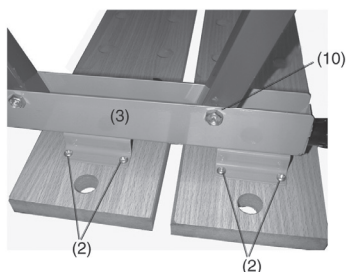

[B]

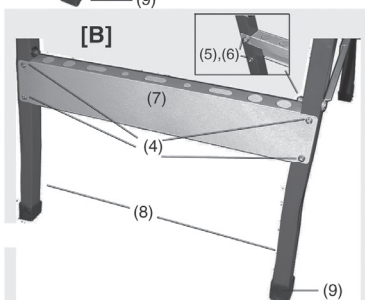

1. NEPOUŽÍVAJTE AKO REBRÍK

2. ZAŤAŽENIE: max. 100 kg

3. POTREBNÉ NÁRADIE:

A. ŠROUBOVÁK (PHILLIPS 2 A 3)

B. KLADIVO

C. KLÚČ (obsiahnuté v balení)

4. NÁVOD SO ZOZNAMOM

DIELOV K IDENTIFIKÁCIÍ

DIELOV

Materiál:

ocel' (25mm štvorcový prierez) /

doska MDF

Rozmery rozložený:

605 × 630 × 755mm

Rozmery zložený:

605 × 150 × 920mm

Rozmery doska::

605 × 120 × 18mm

Max. zaťaženie:

100kg

Hrubá hmotnosť:

5.6kg

Čistá hmotnosť:

5.2kg