

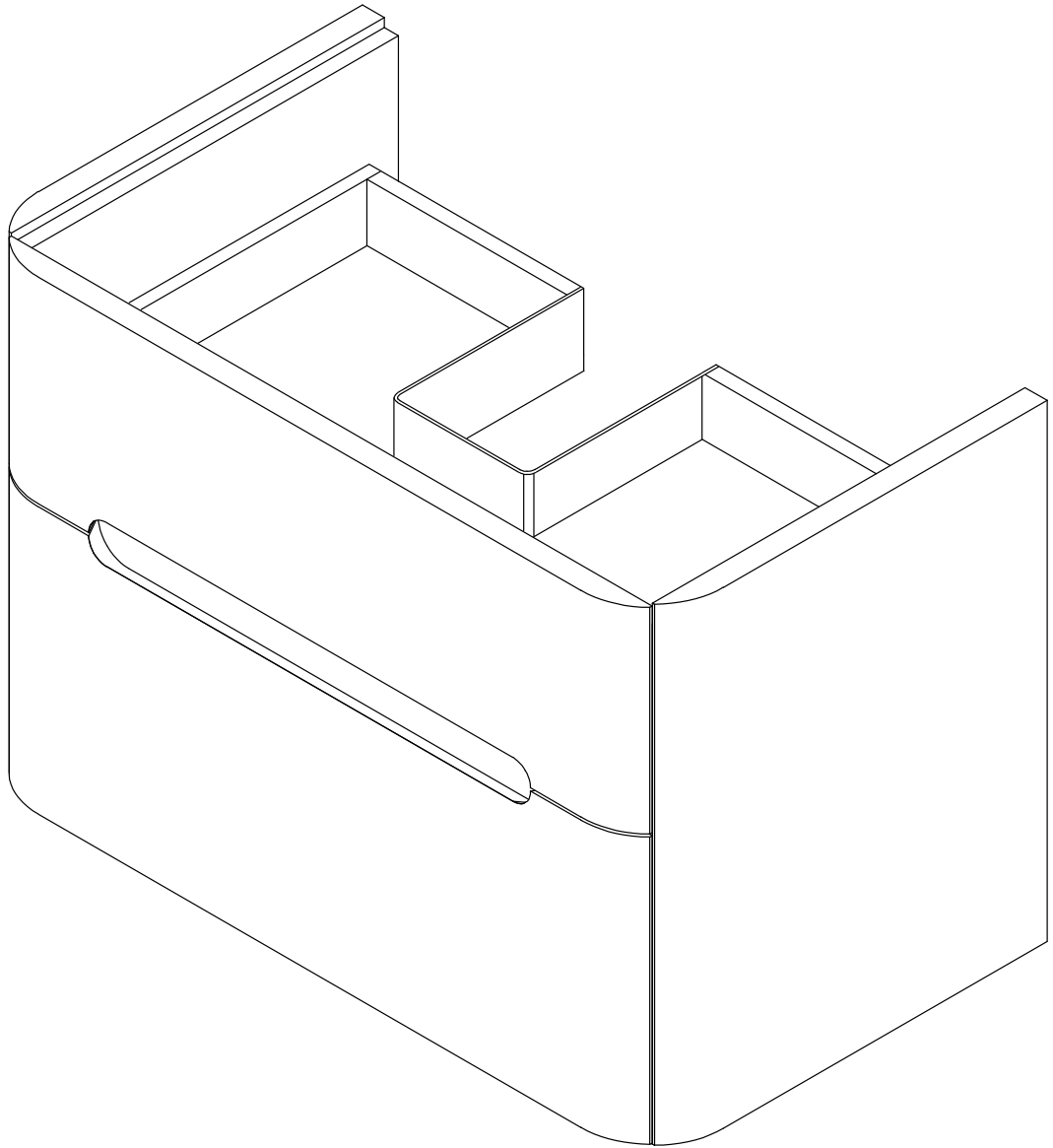

SAT

**SATFUSION280BE
SATFUSION280W
SATFUSION280DM**



1

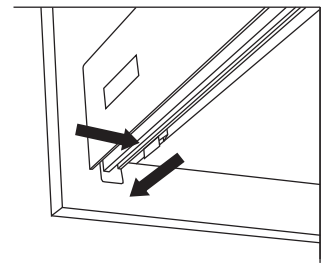
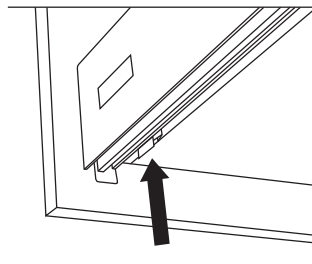
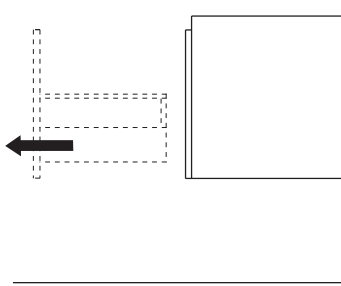

2

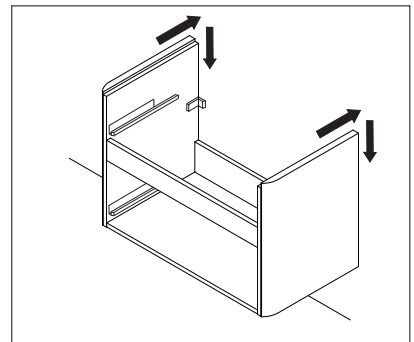
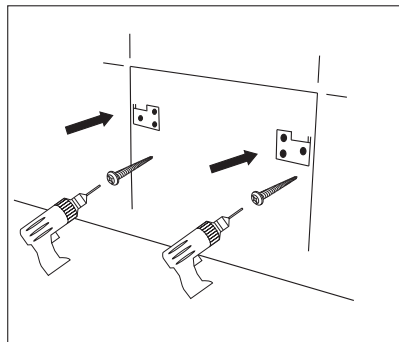
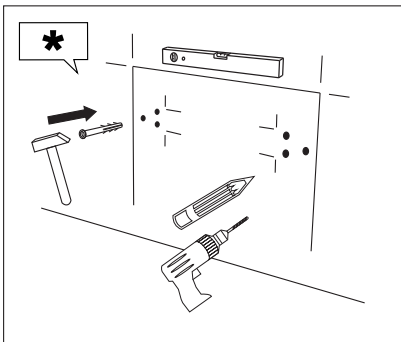
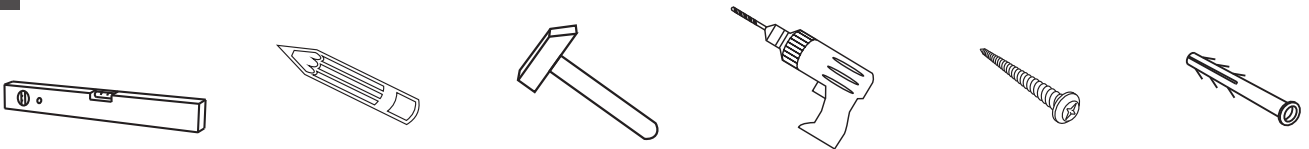

3

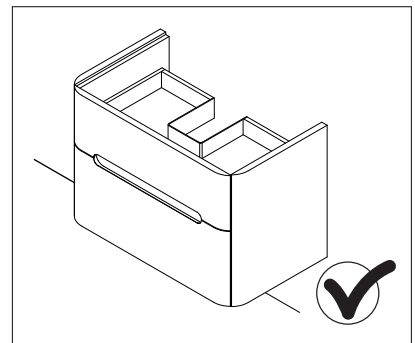
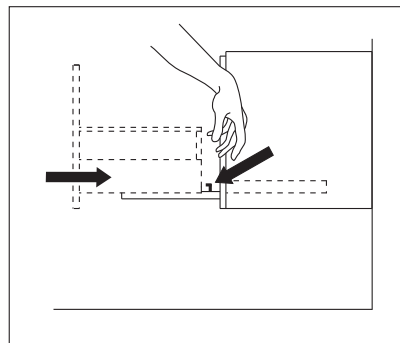
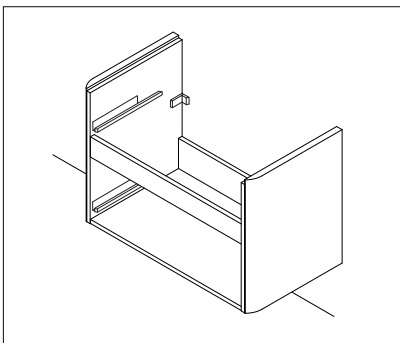

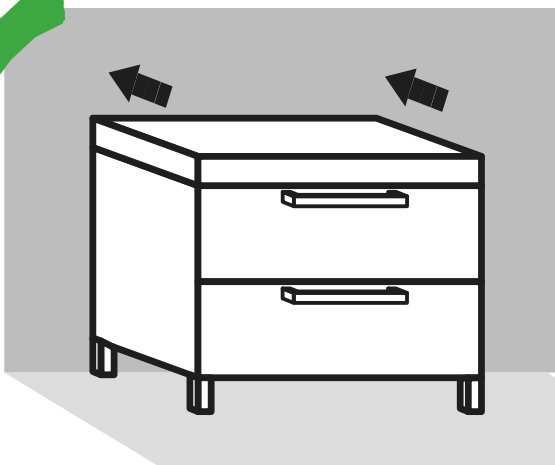
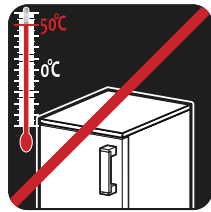
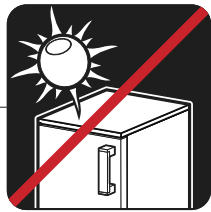
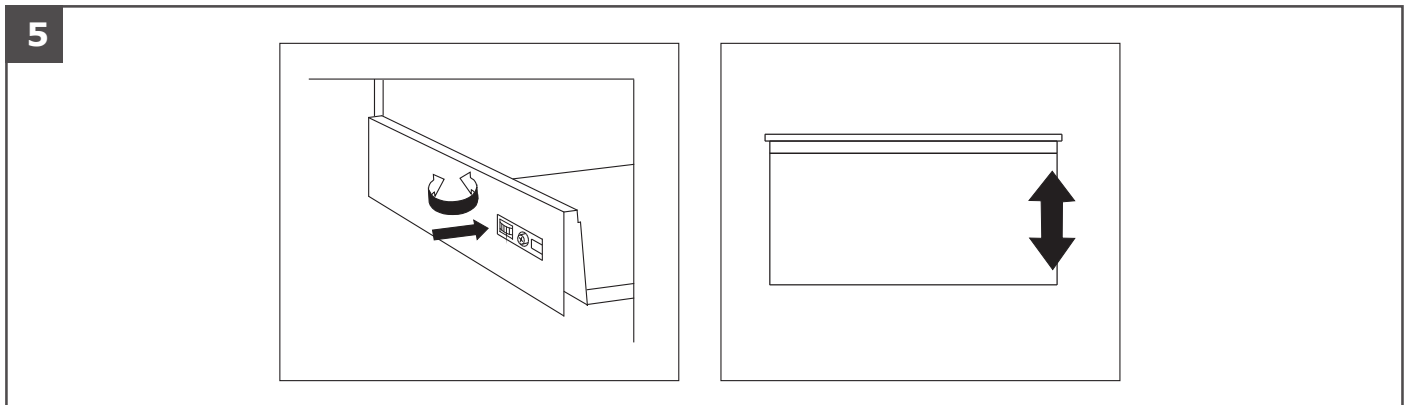
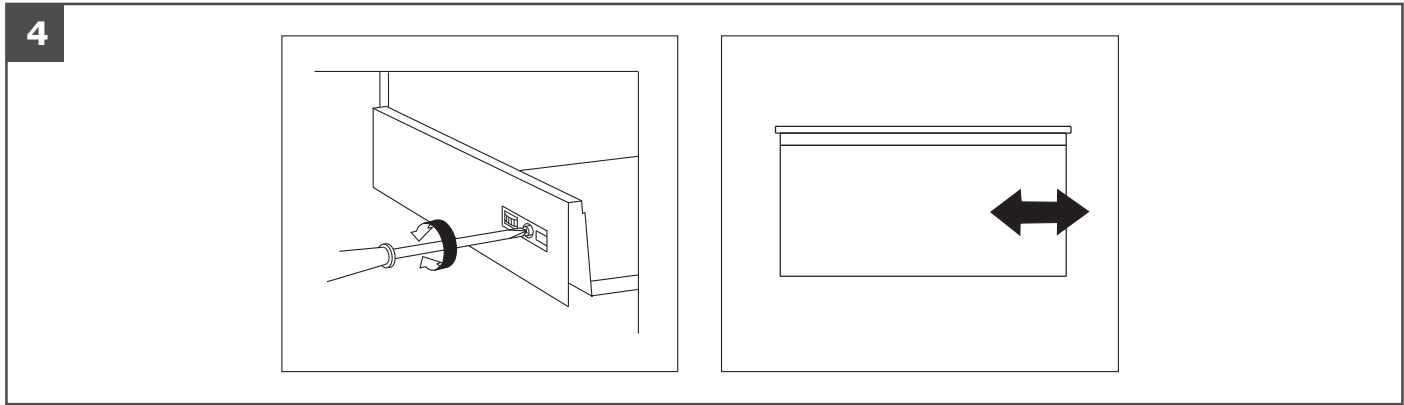

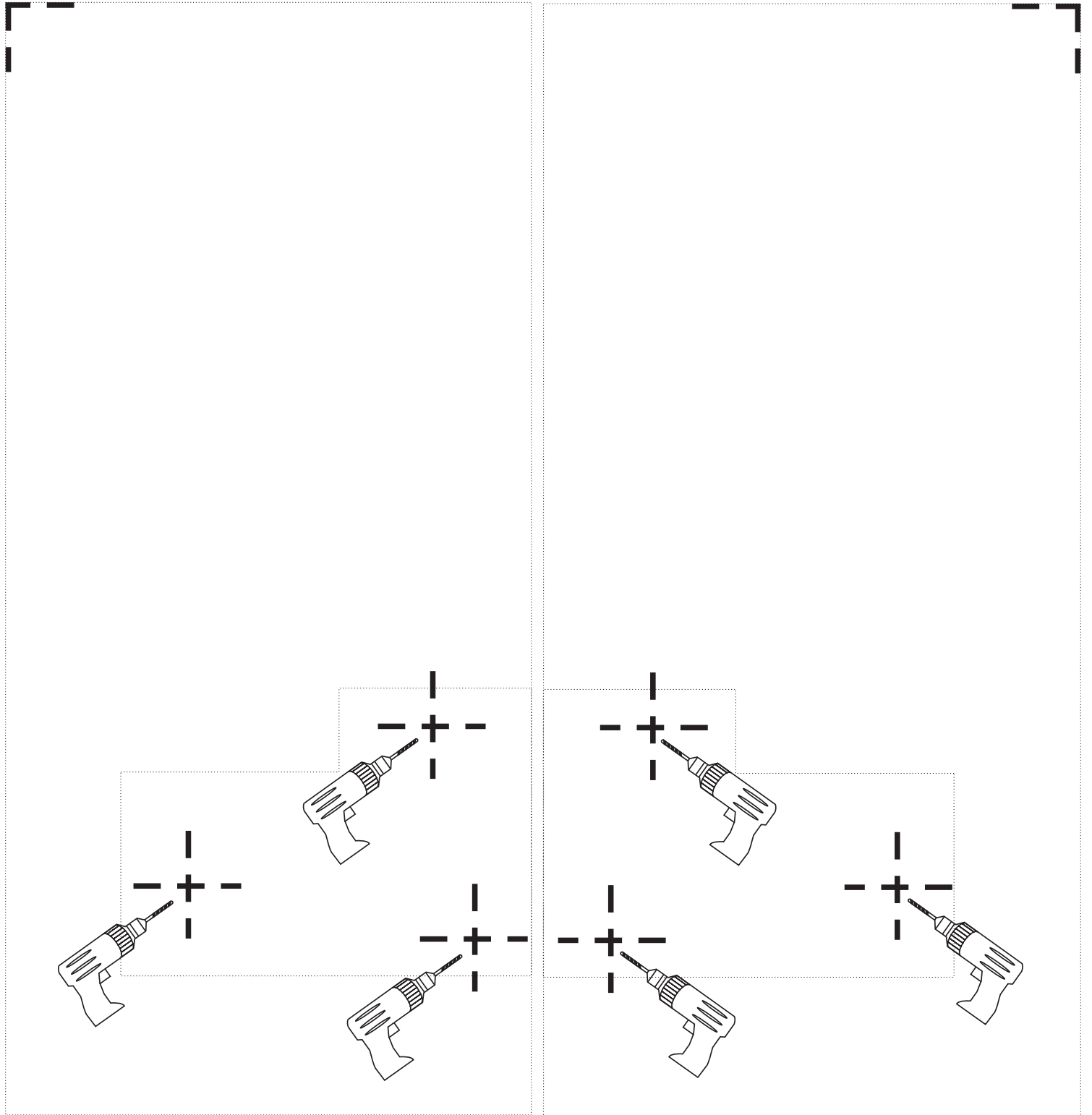
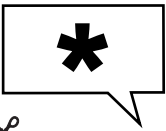

SAT® is registered trademark of



**Swiss
Aqua
Technologies**

Swiss Aqua Technologies AG
Gewerbstrasse 9, 6330 Cham, Switzerland
www.swatec.ch
Imported by SIKO KOUPELNY a.s.
Made in Czech Republic