

DF

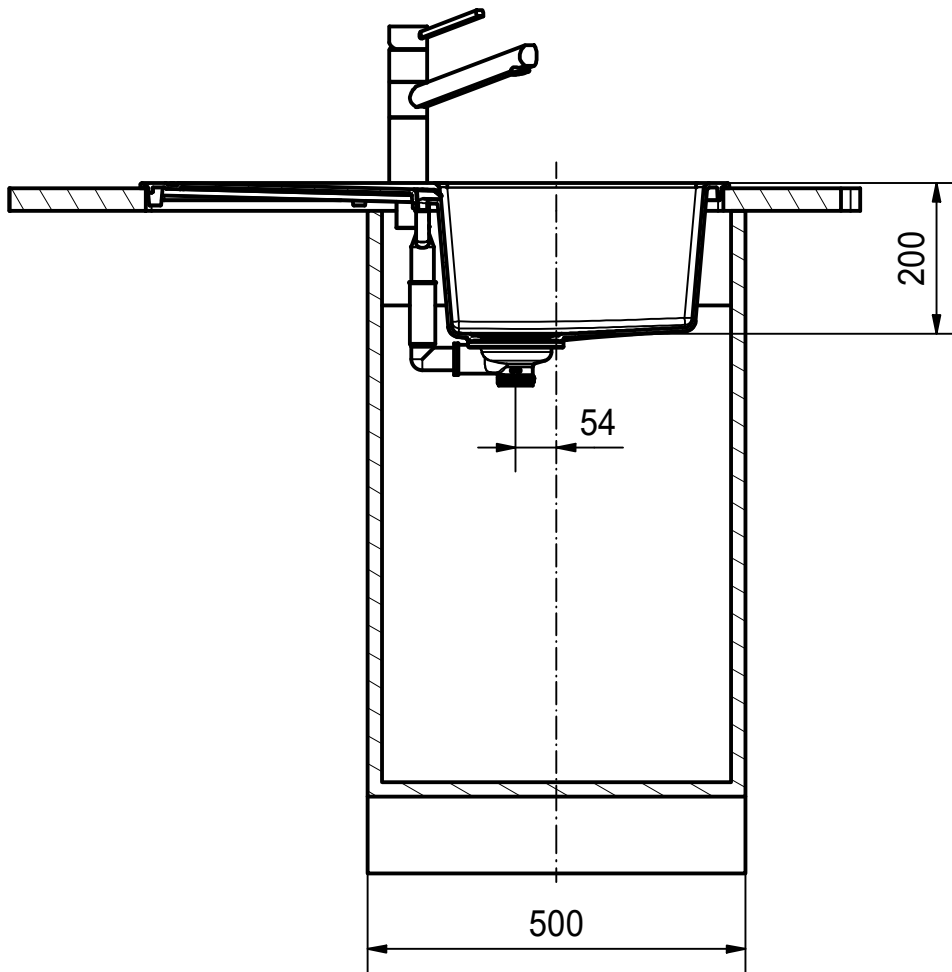

Drawing No.	20129576_01	Revision	-
Drawn Date	20.09.2018		
<small>These drawings and specifications are the property of Franke Technology and Trademark Ltd. and shall not be reproduced, copied or transferred to any third party without the prior written permission of Franke Technology and Trademark Ltd., Hergiswil, Switzerland</small>			

Franke Küchentechnik AG  
CH-4663 Aarburg  
Phone: +41 62 787 31 31  
Internet: www.franke.com

# S2D 611-78 (500)

installing document

Sheet	Sheets
1	6

DS

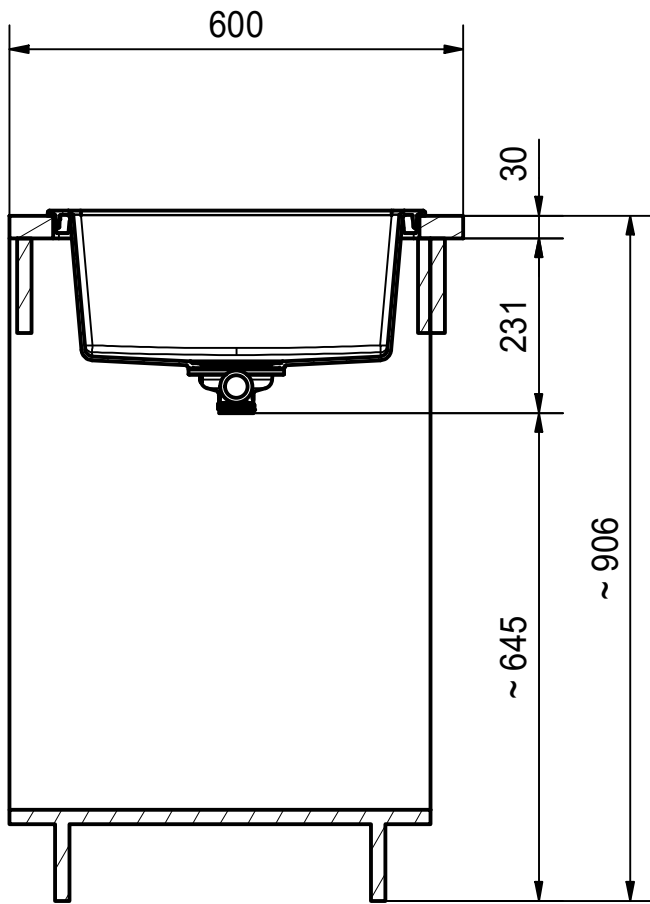

Drawing No.	20129576_01	Revision	-
Drawn Date	20.09.2018		
<small>These drawings and specifications are the property of Franke Technology and Trademark Ltd. and shall not be reproduced, copied or transferred to any third party without the prior written permission of Franke Technology and Trademark Ltd., Hergiswil, Switzerland</small>			

Franke Küchentechnik AG  
CH-4663 Aarburg  
Phone: +41 62 787 31 31  
Internet: www.franke.com

**S2D 611-78 (500)**  
installing document

Sheet	Sheets
2	6

CO

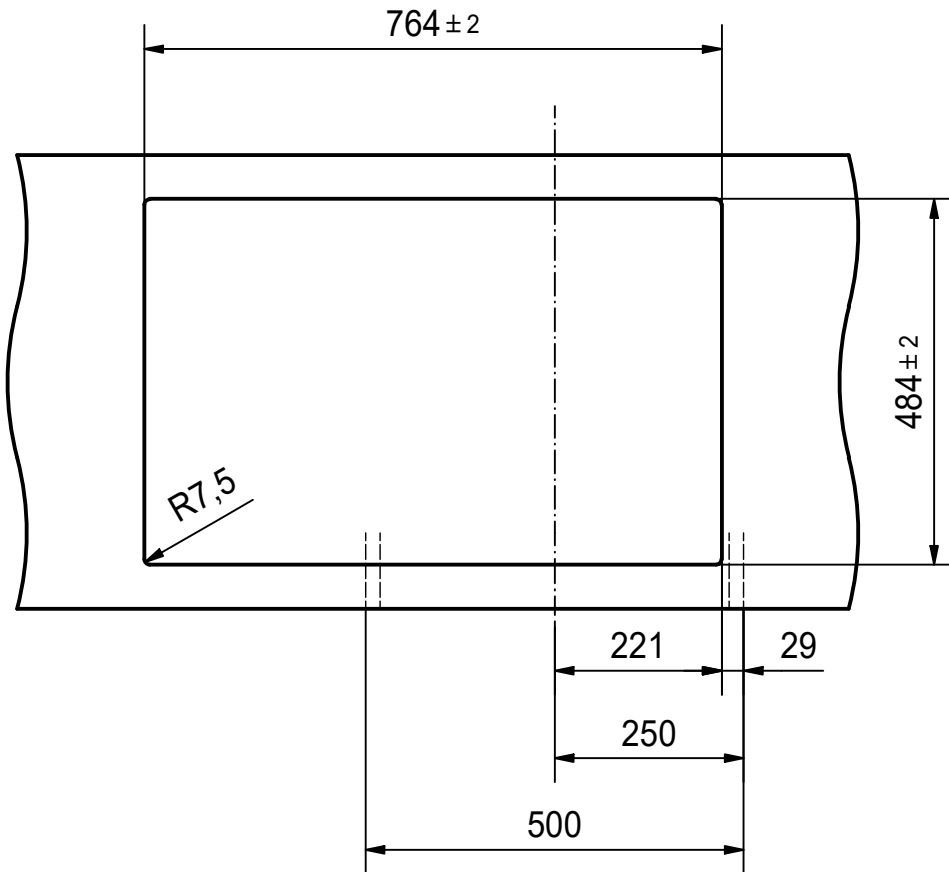

Drawing No.	20129576_01	Revision	-
Drawn Date	20.09.2018		
<small>These drawings and specifications are the property of Franke Technology and Trademark Ltd. and shall not be reproduced, copied or transferred to any third party without the prior written permission of Franke Technology and Trademark Ltd., Hergiswil, Switzerland</small>			

Franke Küchentechnik AG  
CH-4663 Aarburg  
Phone: +41 62 787 31 31  
Internet: www.franke.com

**S2D 611-78 (500)**  
installing document

Sheet	Sheets
3	6

**CNC**

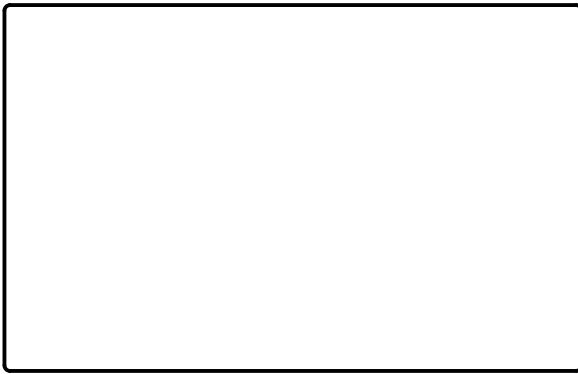

Drawing No.	20129576_01	Revision	-
Drawn Date	20.09.2018		
<small>These drawings and specifications are the property of Franke Technology and Trademark Ltd. and shall not be reproduced, copied or transferred to any third party without the prior written permission of Franke Technology and Trademark Ltd., Hergiswil, Switzerland</small>			

Franke Küchentechnik AG  
CH-4663 Aarburg  
Phone: +41 62 787 31 31  
Internet: www.franke.com

**S2D 611-78 (500)**  
installing document

Sheet	Sheets
4	6

DT

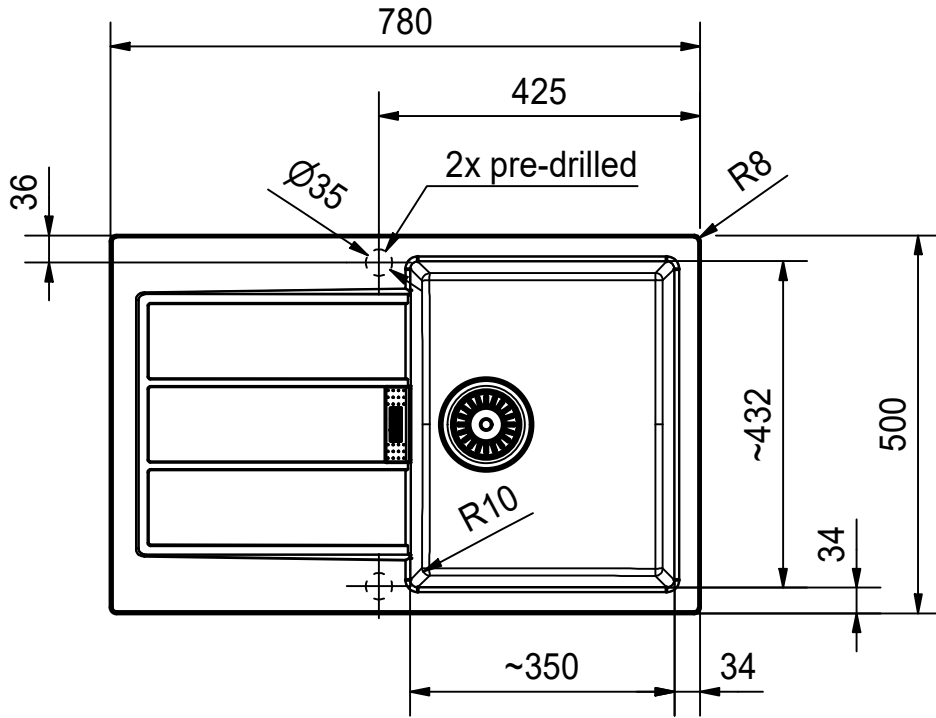

Drawing No.	20129576_01	Revision	-
Drawn Date	20.09.2018		
<small>These drawings and specifications are the property of Franke Technology and Trademark Ltd. and shall not be reproduced, copied or transferred to any third party without the prior written permission of Franke Technology and Trademark Ltd., Hergiswil, Switzerland</small>			

Franke Küchentechnik AG  
CH-4663 Aarburg  
Phone: +41 62 787 31 31  
Internet: www.franke.com

# S2D 611-78 (500)

installing document

Sheet	Sheets
5	6

ISO

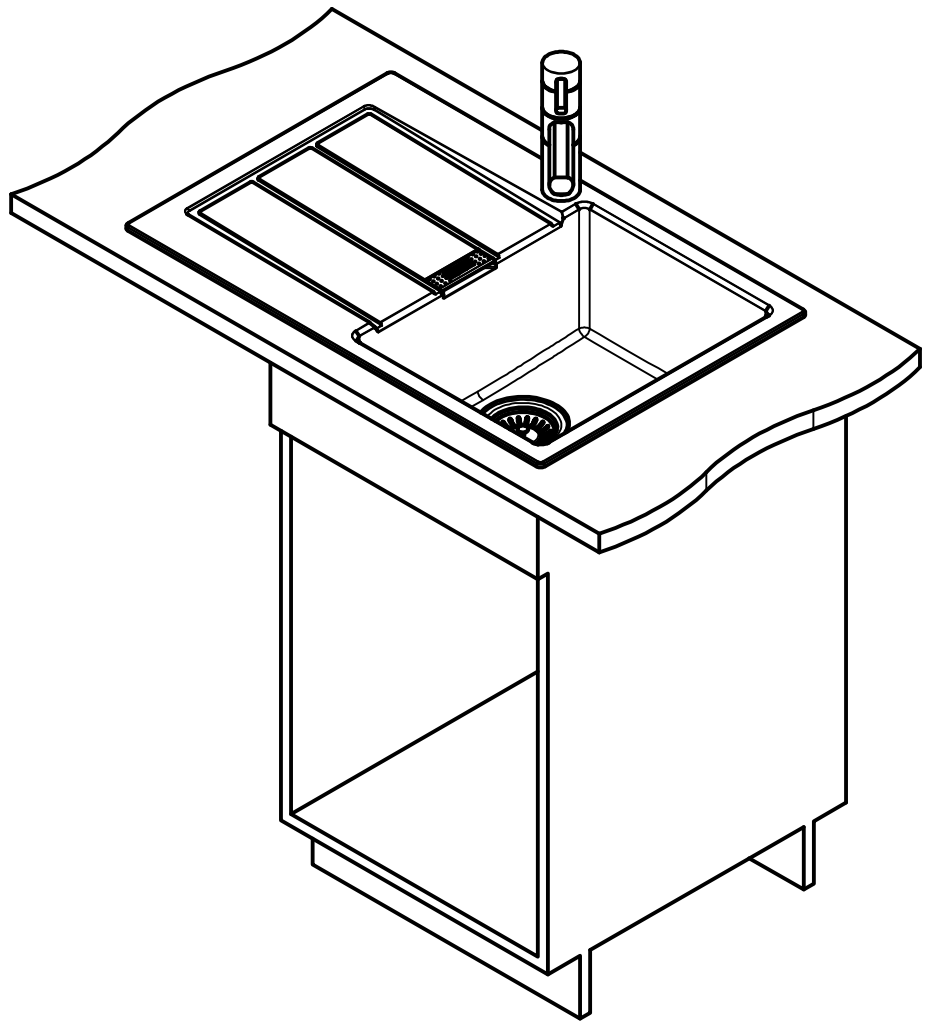

Drawing No.	20129576_01	Revision	-
Drawn Date	20.09.2018		
<small>These drawings and specifications are the property of Franke Technology and Trademark Ltd. and shall not be reproduced, copied or transferred to any third party without the prior written permission of Franke Technology and Trademark Ltd., Hergiswil, Switzerland</small>			

Franke Küchentechnik AG  
CH-4663 Aarburg  
Phone: +41 62 787 31 31  
Internet: www.franke.com

**S2D 611-78 (500)**  
installing document

Sheet	Sheets
6	6