

DF

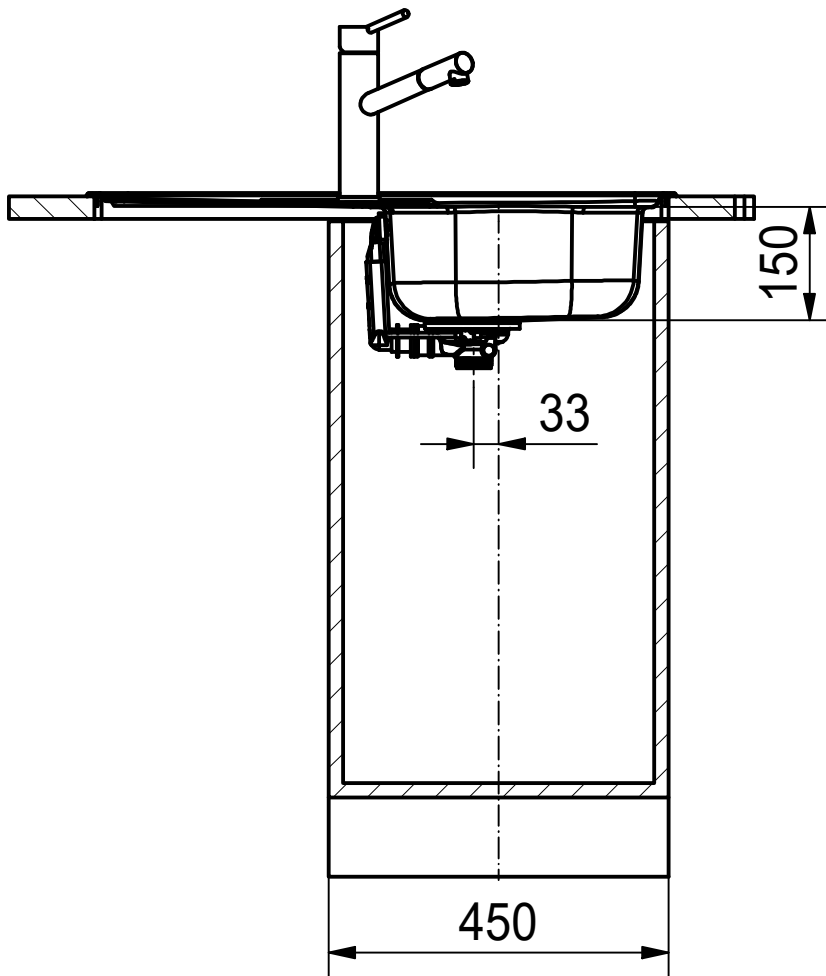

Drawing No.	20256256_01	Revision	-
Drawn Date	17.08.2023		
These drawings and specifications are the property of Franke Technology and Trademark Ltd., Hergiswil, Switzerland.			



FL 611-78x44 rev SI
Installing document

Sheet	Sheets
1	6

DS

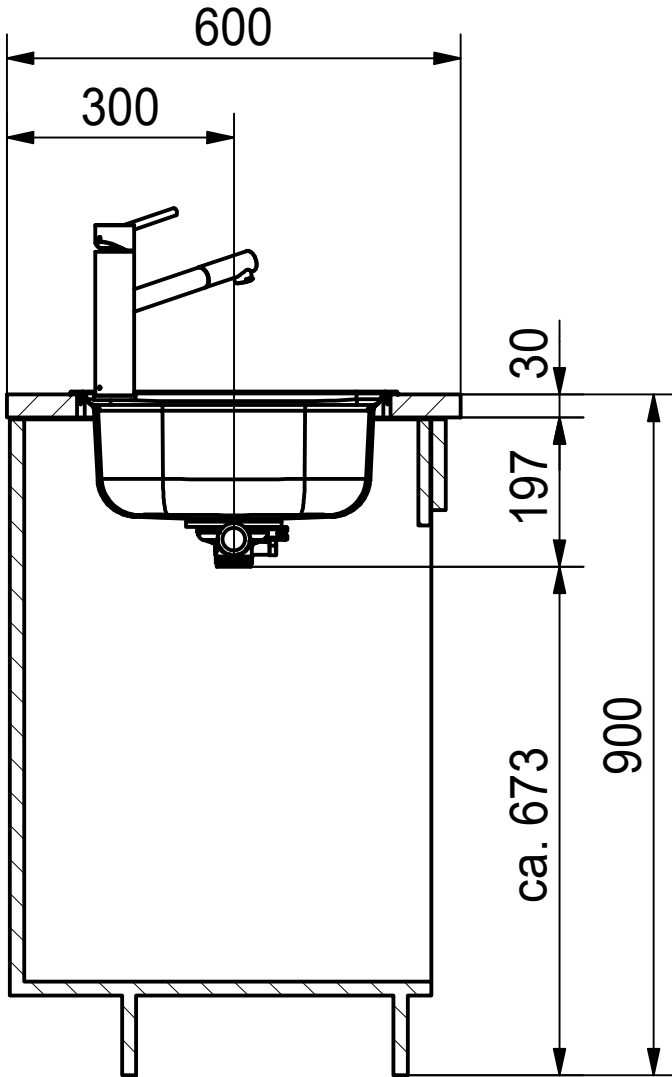

Drawing No.	20256256_01	Revision	-
Drawn Date	17.08.2023		
These drawings and specifications are the property of Franke Technology and Trademark Ltd., Hergiswil, Switzerland.			



FL 611-78x44 rev SI
Installing document

Sheet	Sheets
2	6

CO

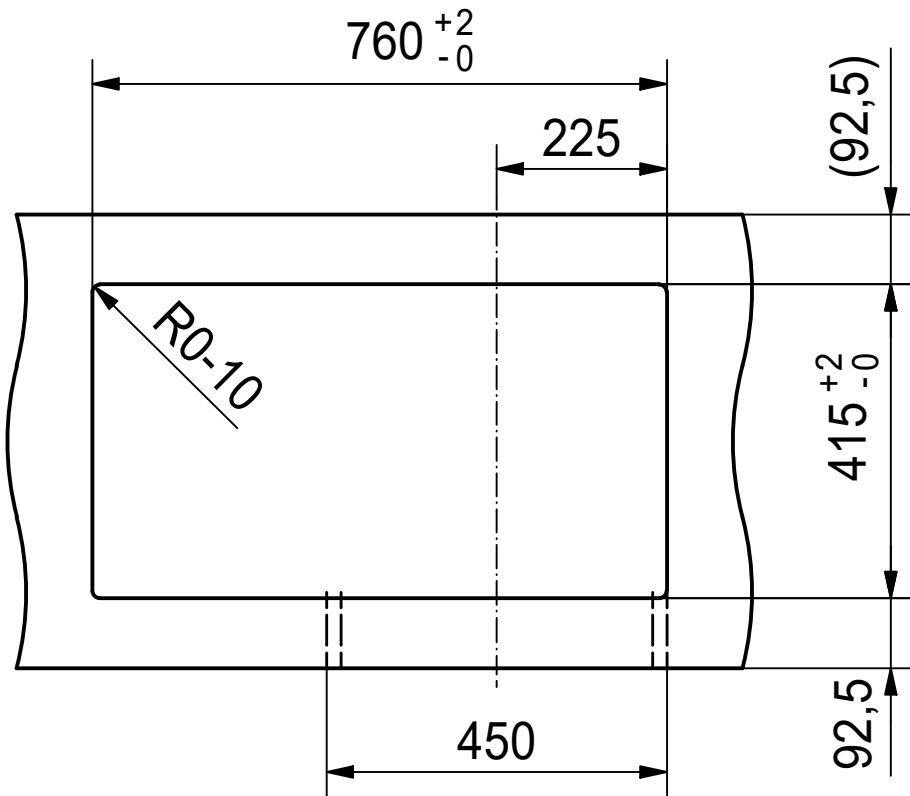

Drawing No.	20256256_01	Revision	-
Drawn Date	17.08.2023		
These drawings and specifications are the property of Franke Technology and Trademark Ltd., Hergiswil, Switzerland.			



FL 611-78x44 rev SI
Installing document

Sheet	Sheets
3	6

CNC



Drawing No.	20256256_01	Revision	-
Drawn Date	17.08.2023		
These drawings and specifications are the property of Franke Technology and Trademark Ltd., Hergiswil, Switzerland.			



FL 611-78x44 rev SI
Installing document

Sheet	Sheets
4	6

DT

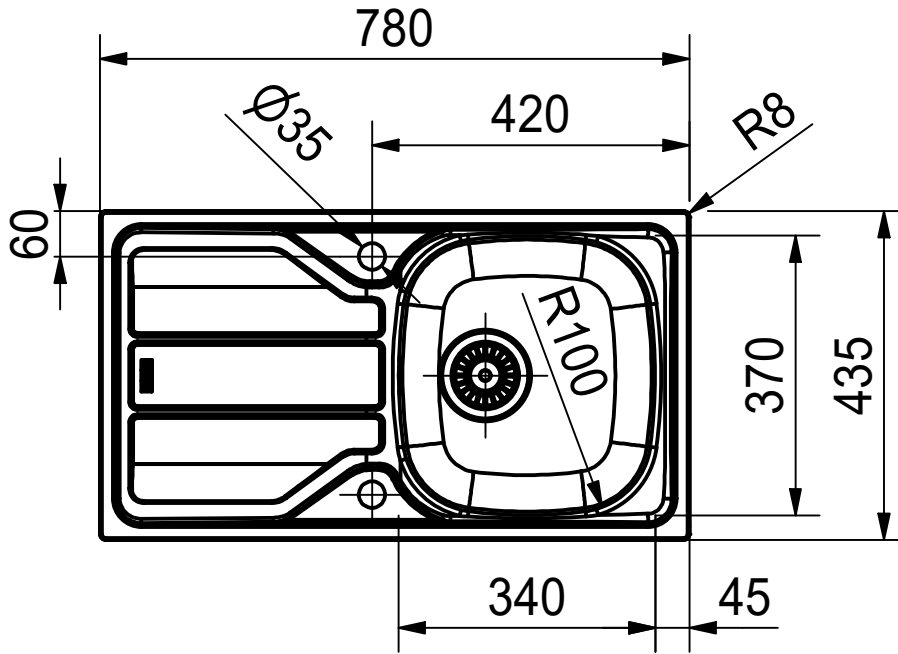

Drawing No.	20256256_01	Revision	-
Drawn Date	17.08.2023		
These drawings and specifications are the property of Franke Technology and Trademark Ltd., Hergiswil, Switzerland.			



FL 611-78x44 rev SI
Installing document

Sheet	Sheets
5	6

ISO

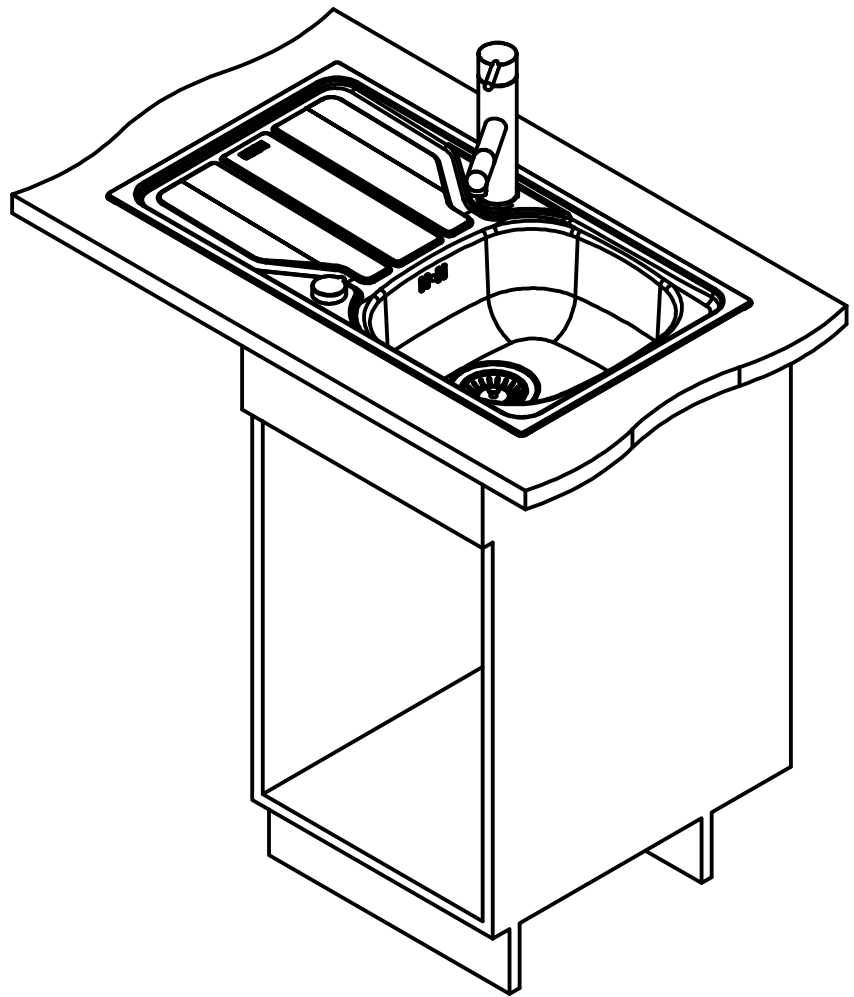

Drawing No.	20256256_01	Revision	-
Drawn Date	17.08.2023		
These drawings and specifications are the property of Franke Technology and Trademark Ltd., Hergiswil, Switzerland.			



FL 611-78x44 rev SI
Installing document

Sheet	Sheets
6	6