

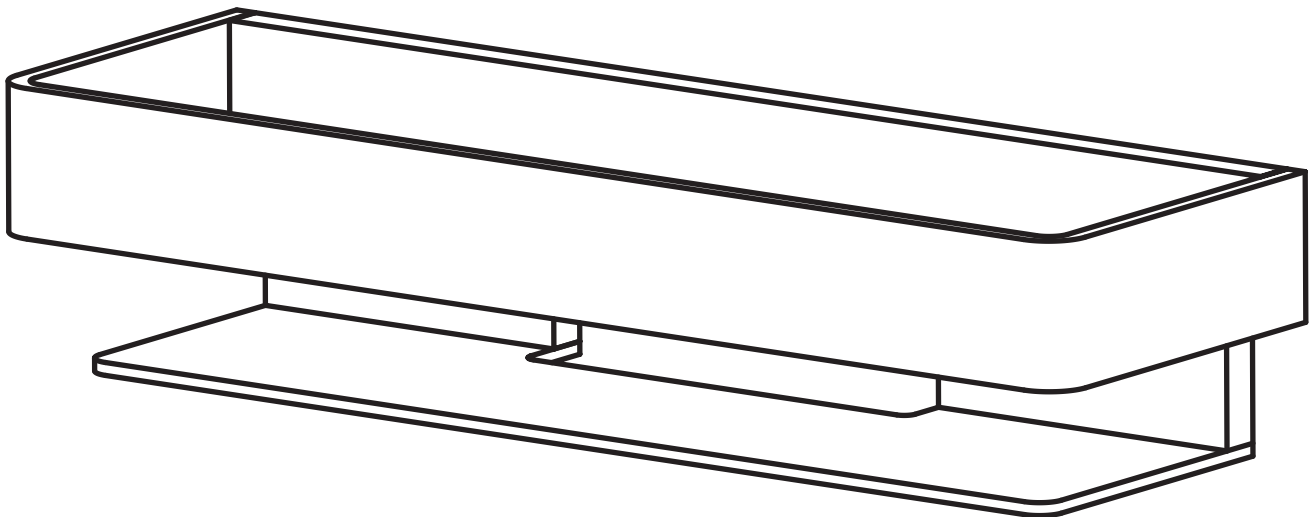

SATDPOL30CH
SATDPOL30MC
SATDPOL30B

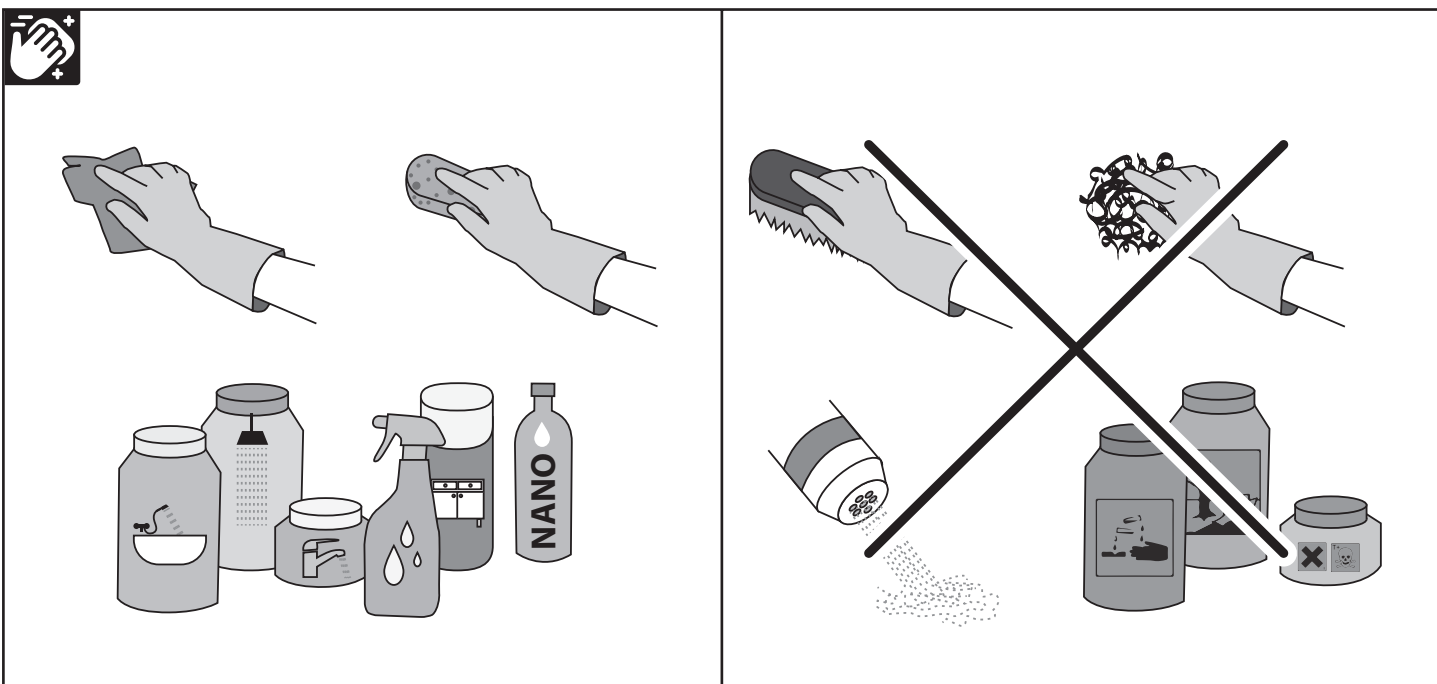

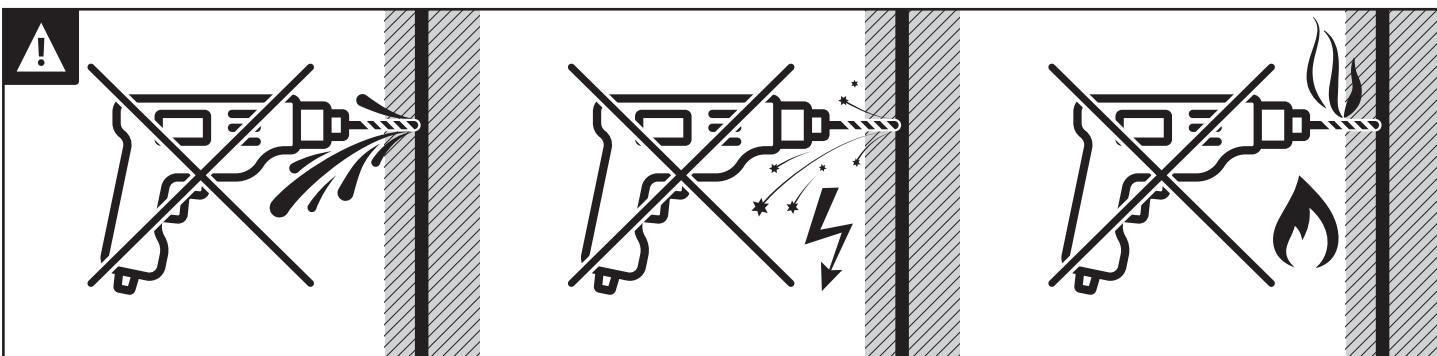

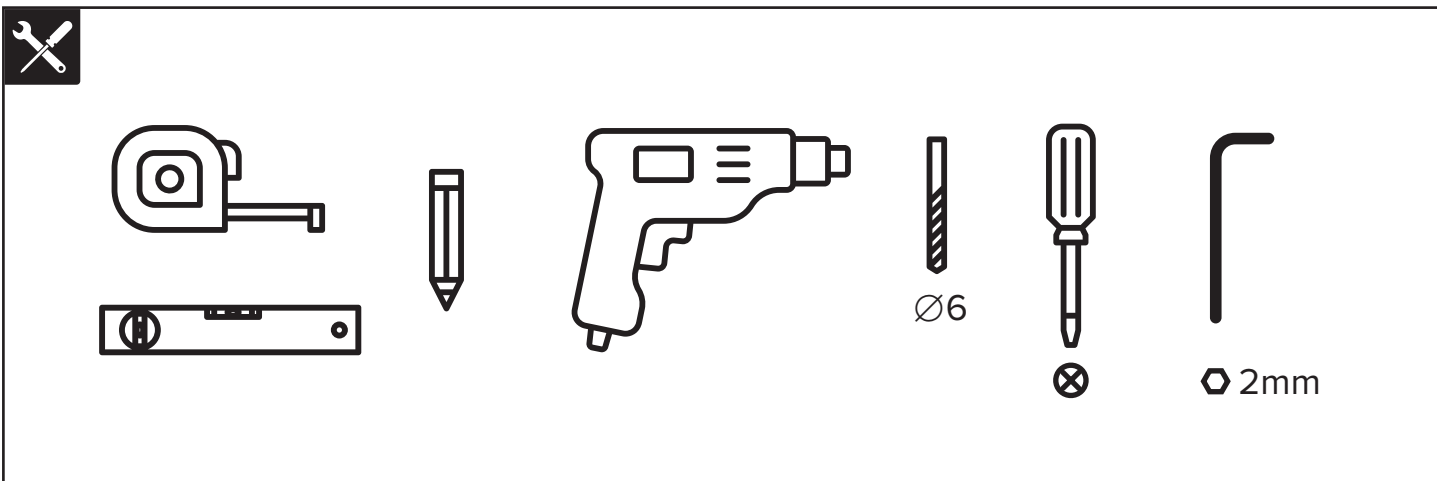
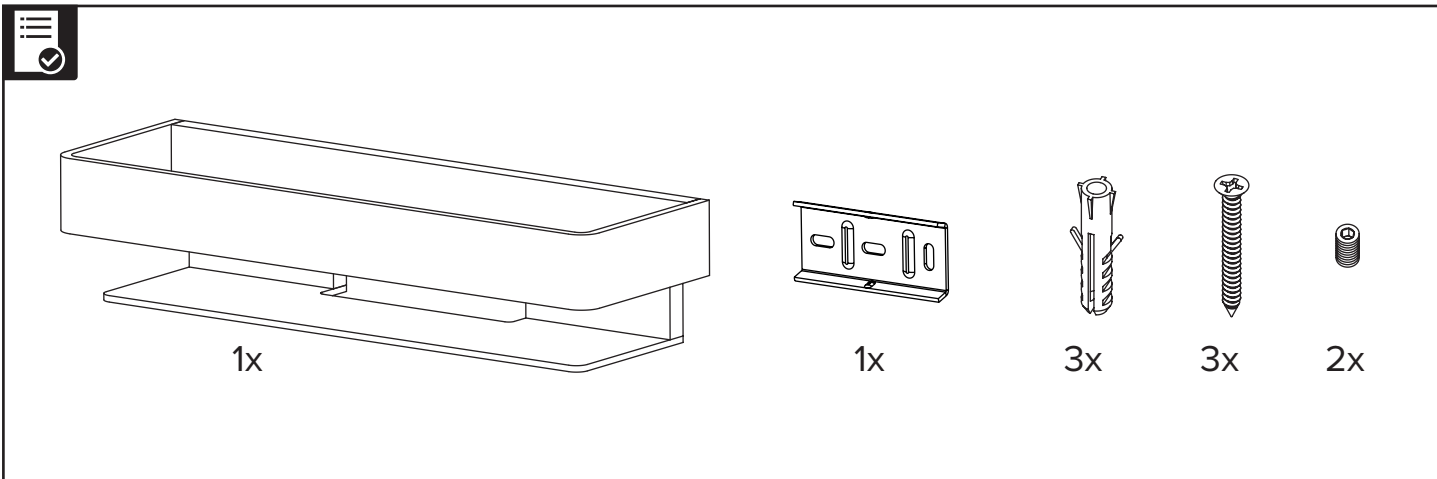
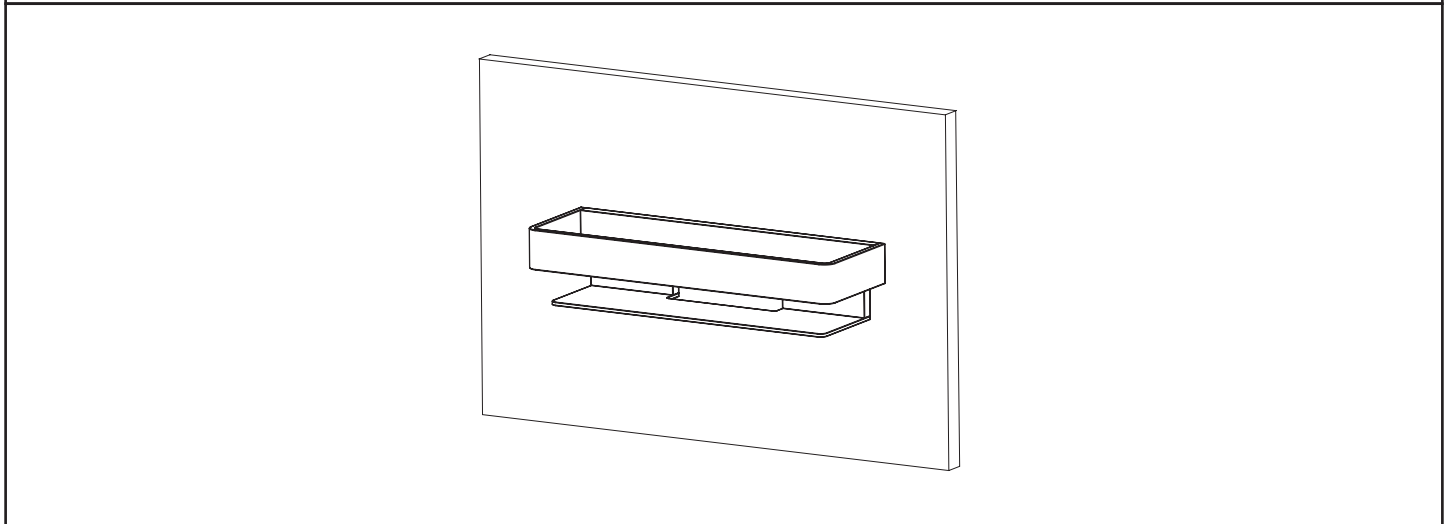
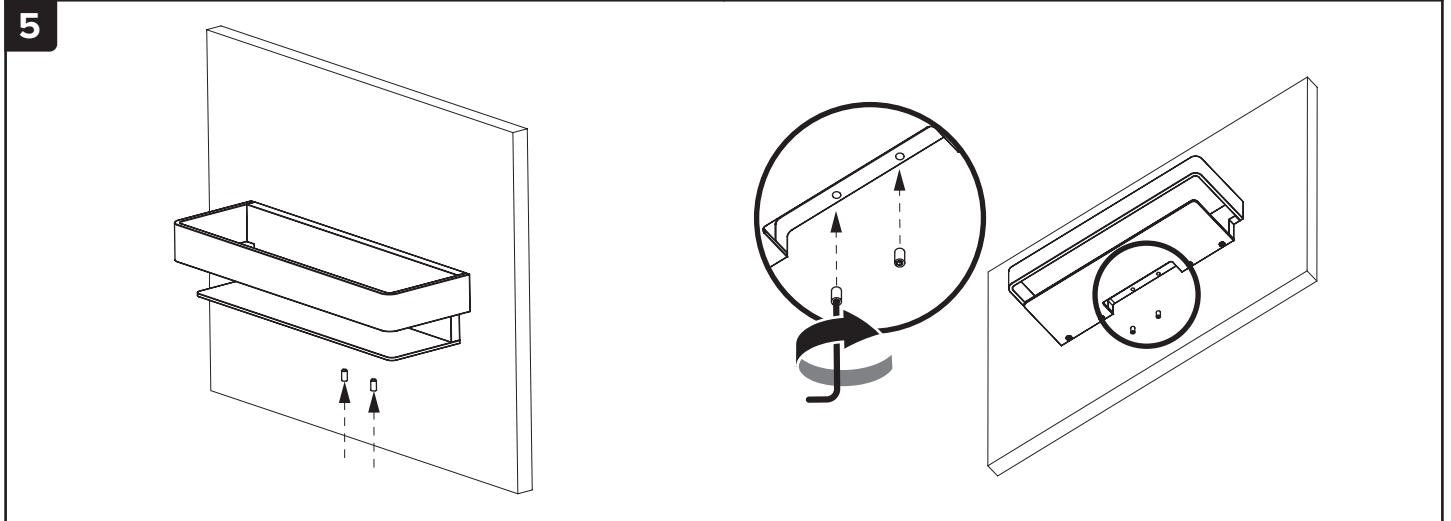
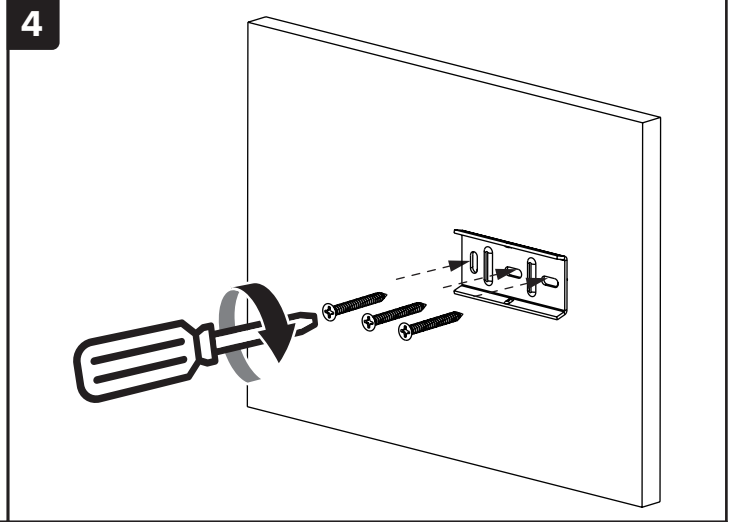
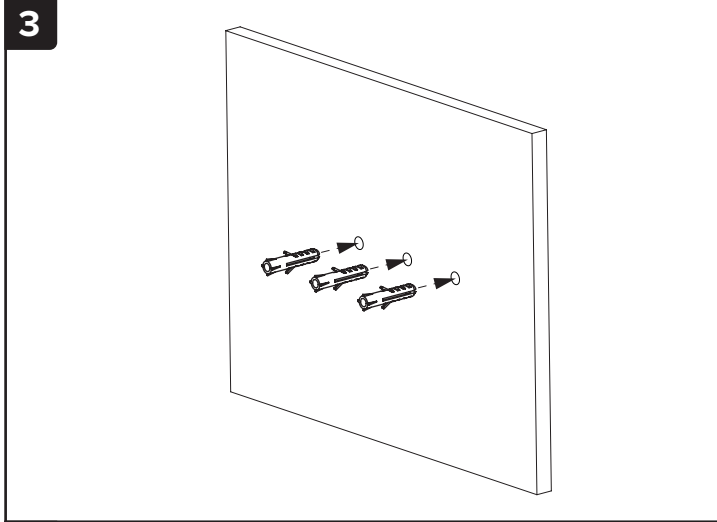
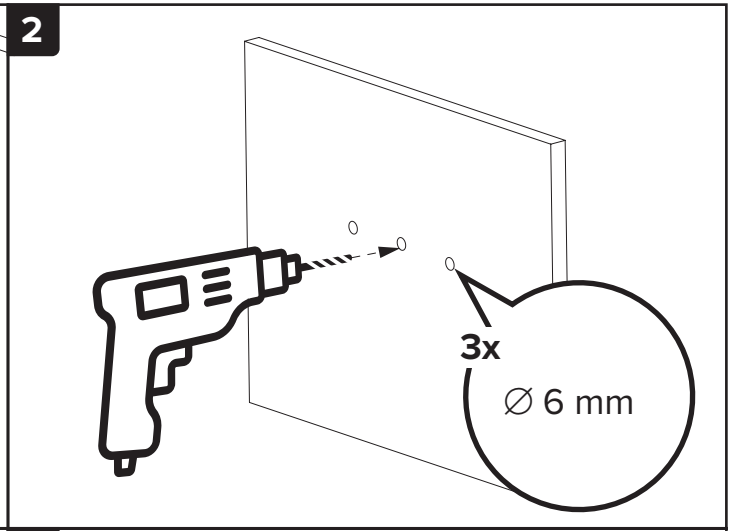
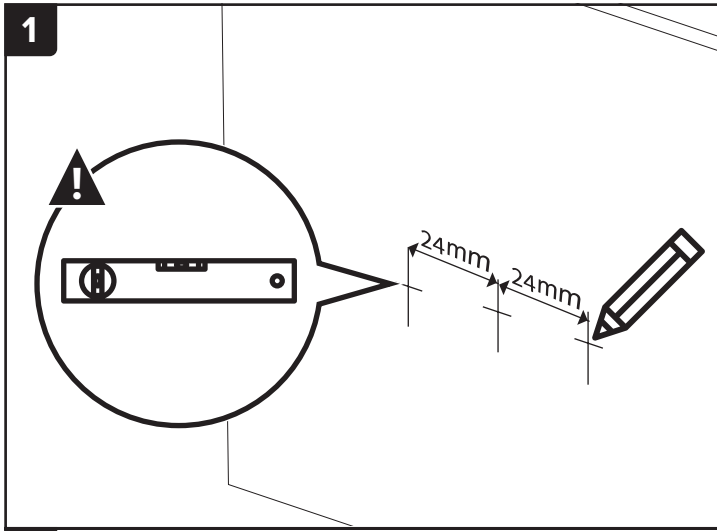

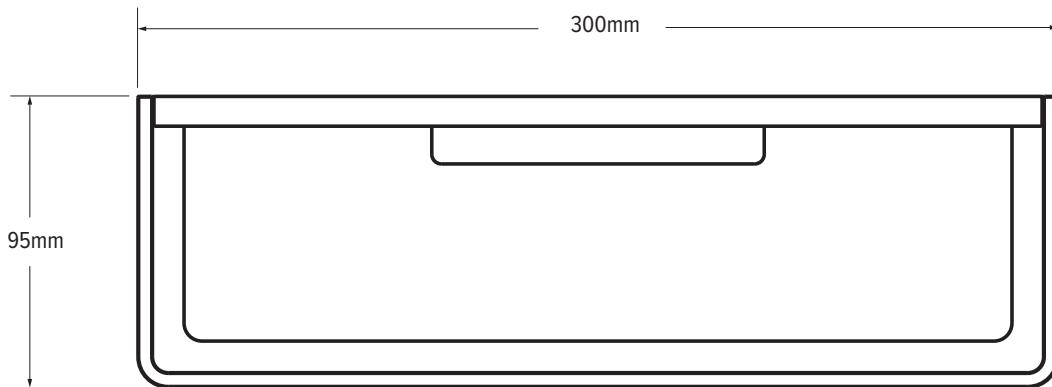
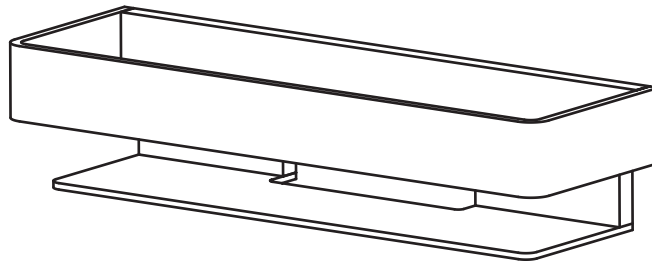

SAT® is registered trademark of



Swiss Aqua Technologies AG
Gewerbstrasse 9, 6330 Cham, Switzerland
www.swatec.ch
Imported by SIKO KOUPELNY a.s.
Made in P.R.C.