

DOLI 180x200

Art.-Nr.

398 697
398 698
398 699
398 700

1836
787
2032
mm

1/6
VO
36-2024

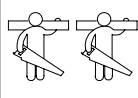

120 min

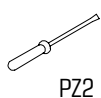

PZ2

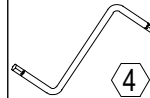

4

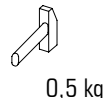

0,5 kg



3m

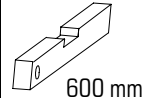

600 mm

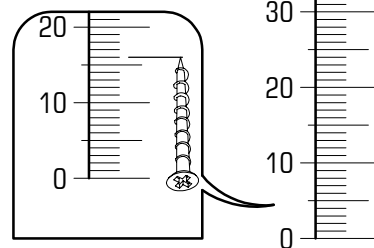
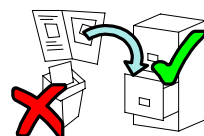
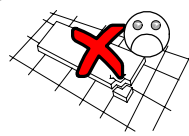
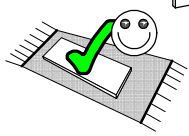
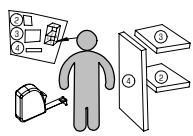
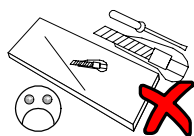
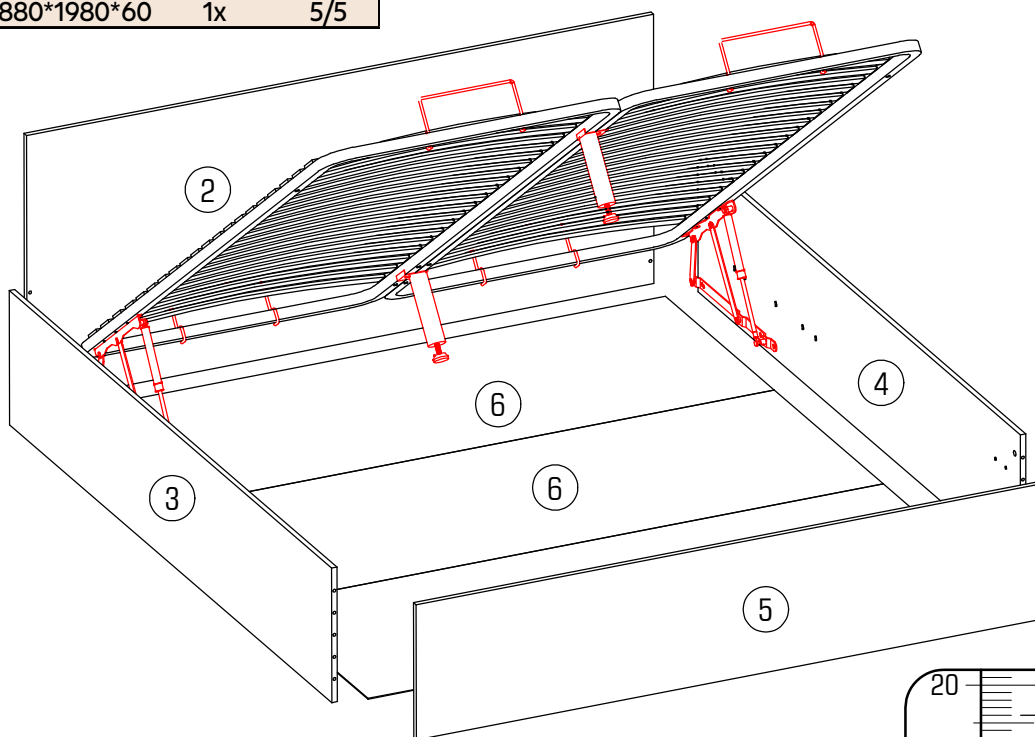
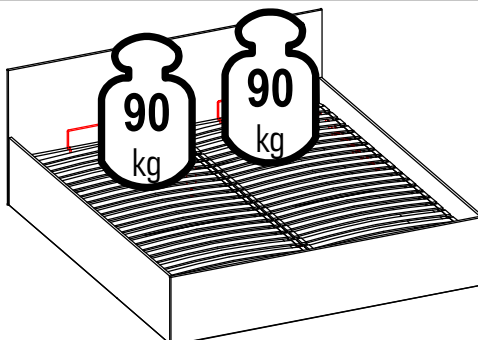

ID EE	ID	Dimensions	Qty	Order
21621	②	1836*780*16	1x	1/5
21587	③	2000*390*16	1x	2/5
21588	④	2000*390*16	1x	2/5
21622	⑤	1836*392*16	1x	2/5
21623	⑥	676*1828*3	3x	1/5
			1x	3/5
			1x	4/5
			1x	5/5



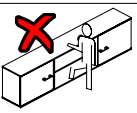
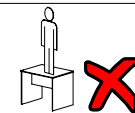
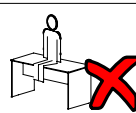
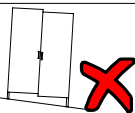
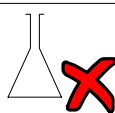

21102,00		Ø1,6x20	22205,02		Ø5,0x16	22510,00		M6,0x14	22300,00		Ø7x50	37148,00		1000 N	37147,00		37146,00		37150,00					
A	100x		B	8x		C	10x		D	6x		E	2x		F	4x	G	2x	H	2x				
22800,01		4	24091,00		Ø10x11	27000,00		Ø8x30	30091,00		10x	70013,01		Ø15x13	70021,01		Q1	Q2						
J	1x		K	10x		L	8x		M	10x		N	6x		P	6x	Q1	6x	Q2	6x				
37106,00		2x	37146,00		2x	37148,00		M6,0x40	37148,00		4x	37148,00		1x	37148,00		1x	37148,00		M6,0	37146,00		M8,0x40	2x
R	2x		S	2x		T	6x		U	4x		V	1x		W	1x	X	6x	Y	2x				

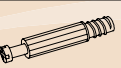

2/6 DOLI 180x200

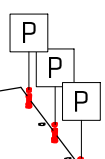
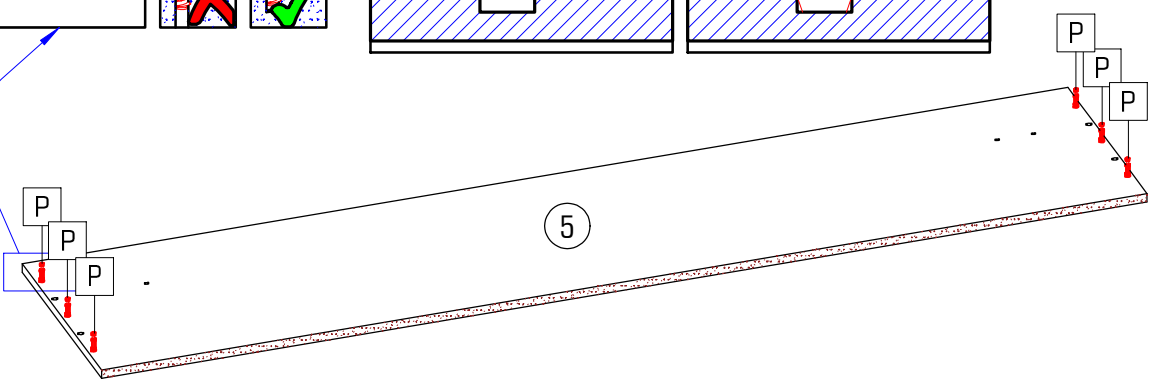
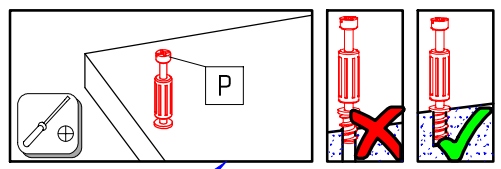
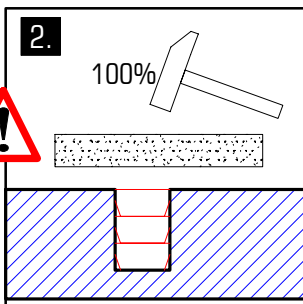
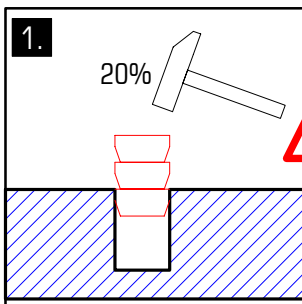
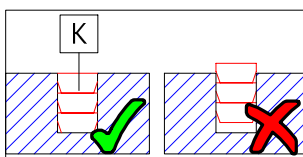
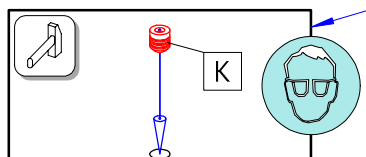
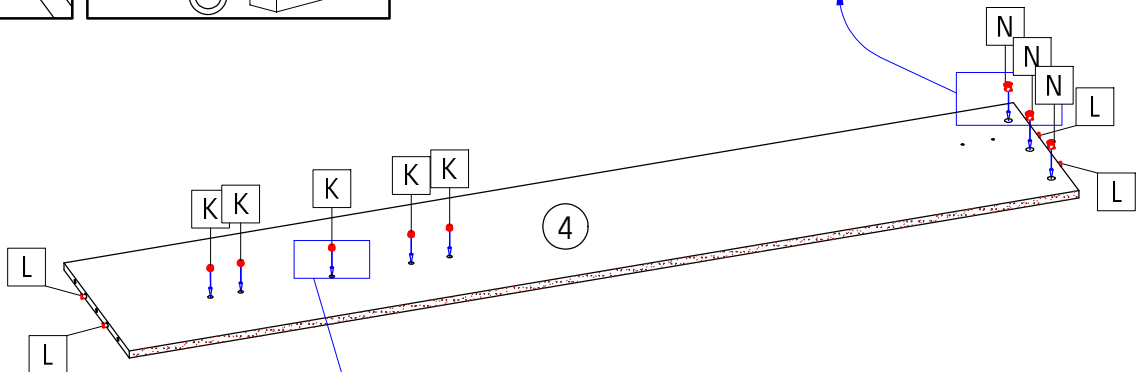
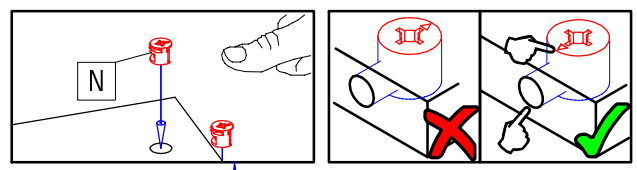
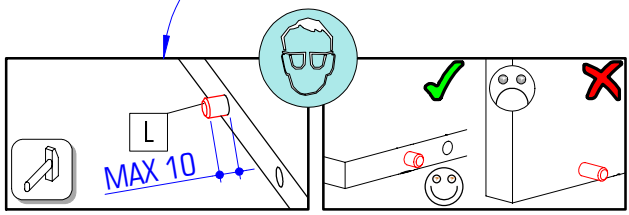
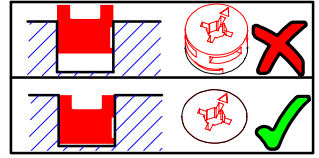
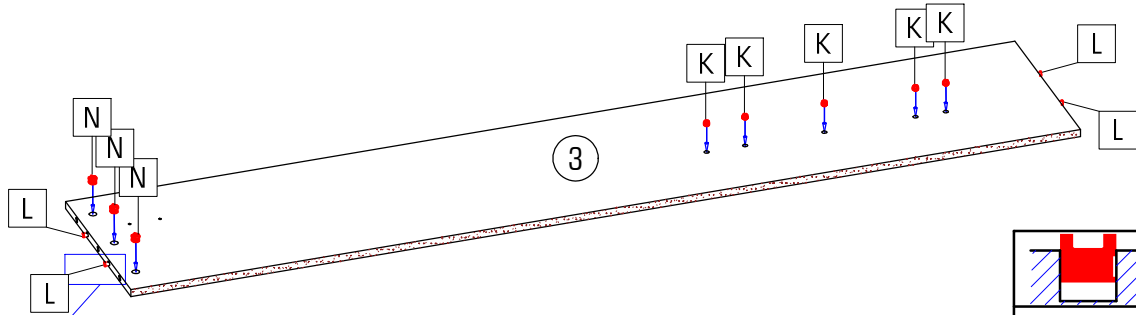
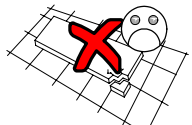
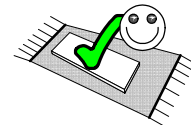

			
Ø10x11	Ø8x30	Ø15x13	
K 10x	L 8x	N 6x	P 6x

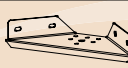

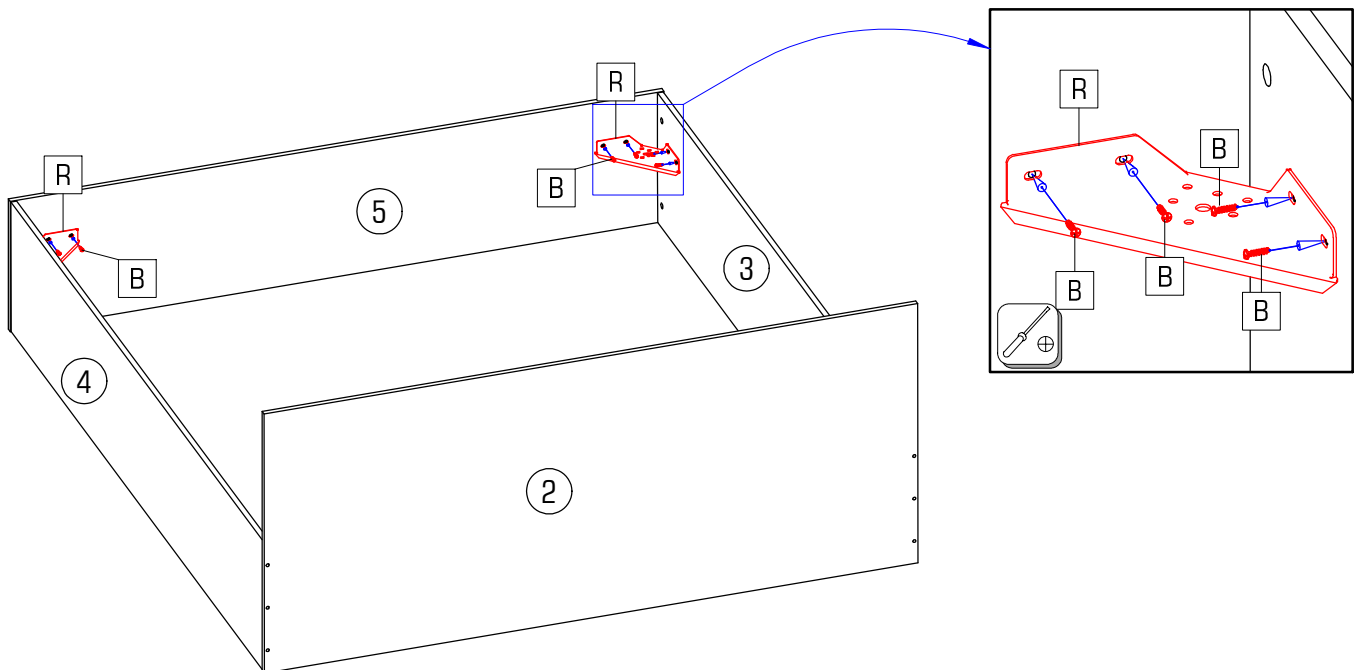
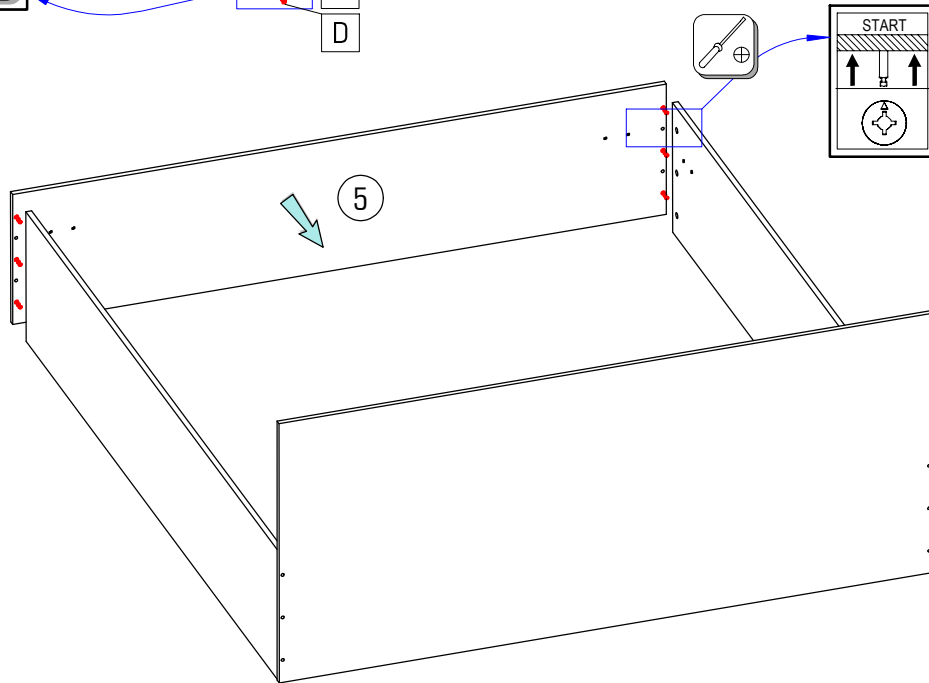
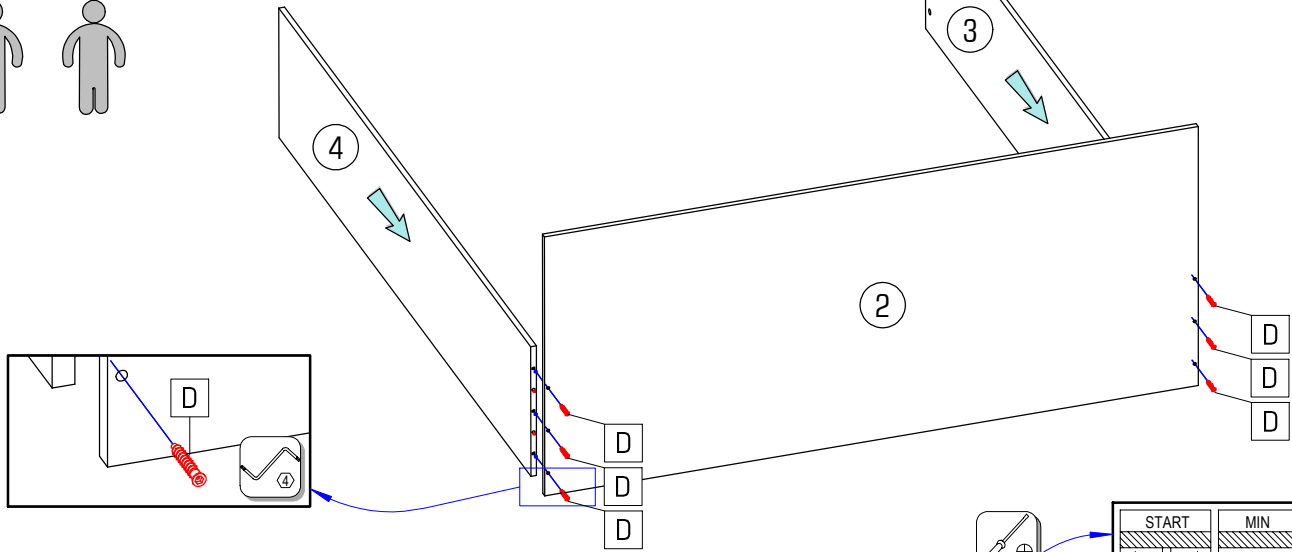
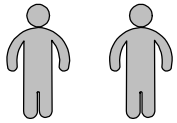
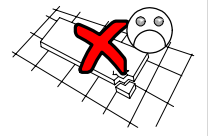
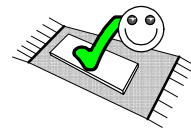

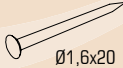

		
Ø5,0x16	Ø7x50	
B 8x	D 6x	R 2x

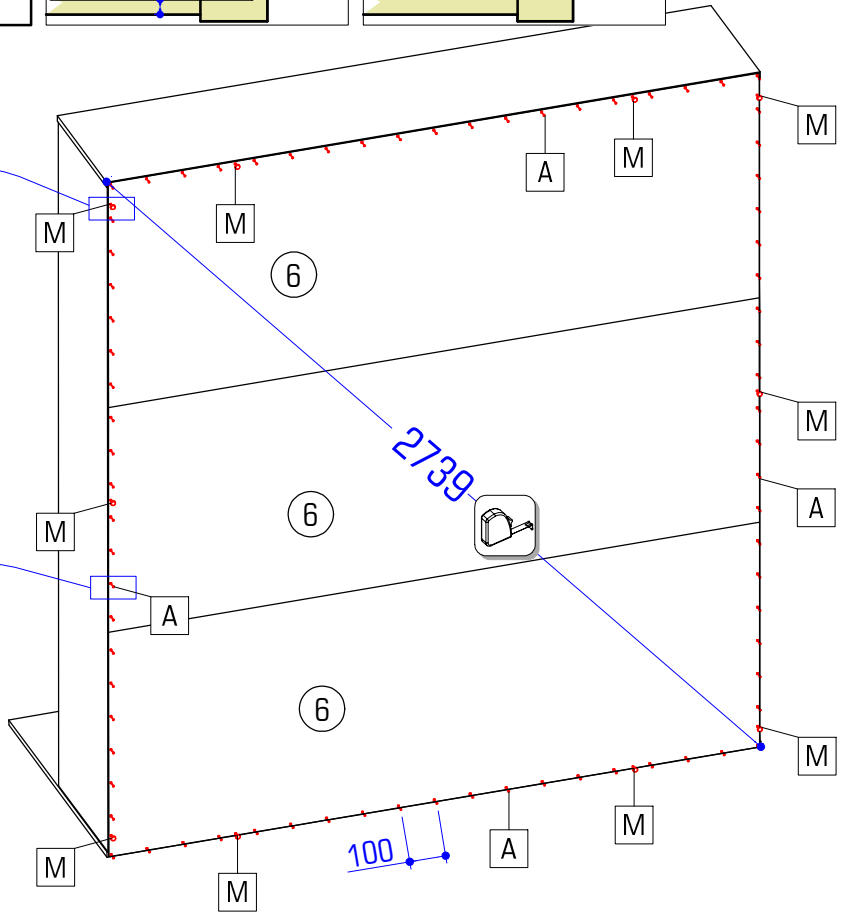
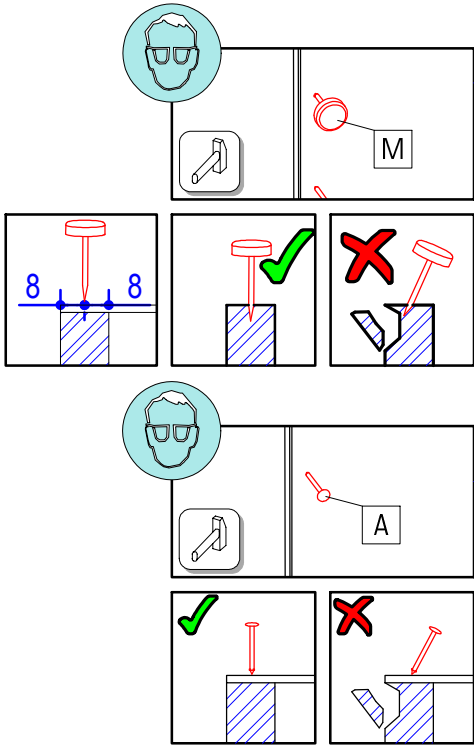
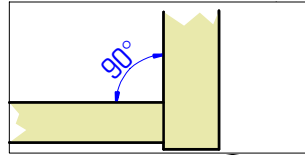
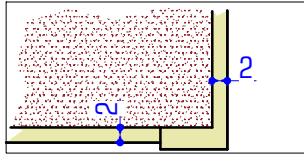
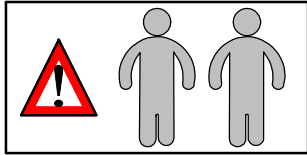

4/6 DOLI 180x200

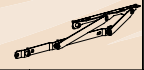

	
A 100x	M 10x



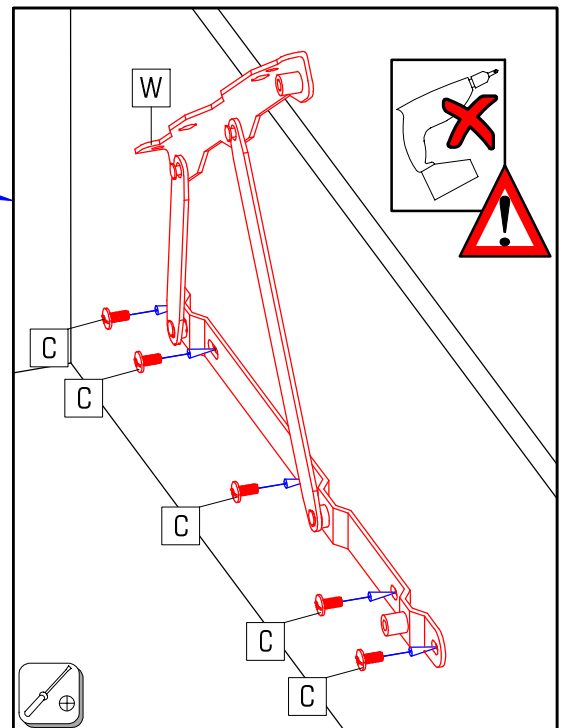
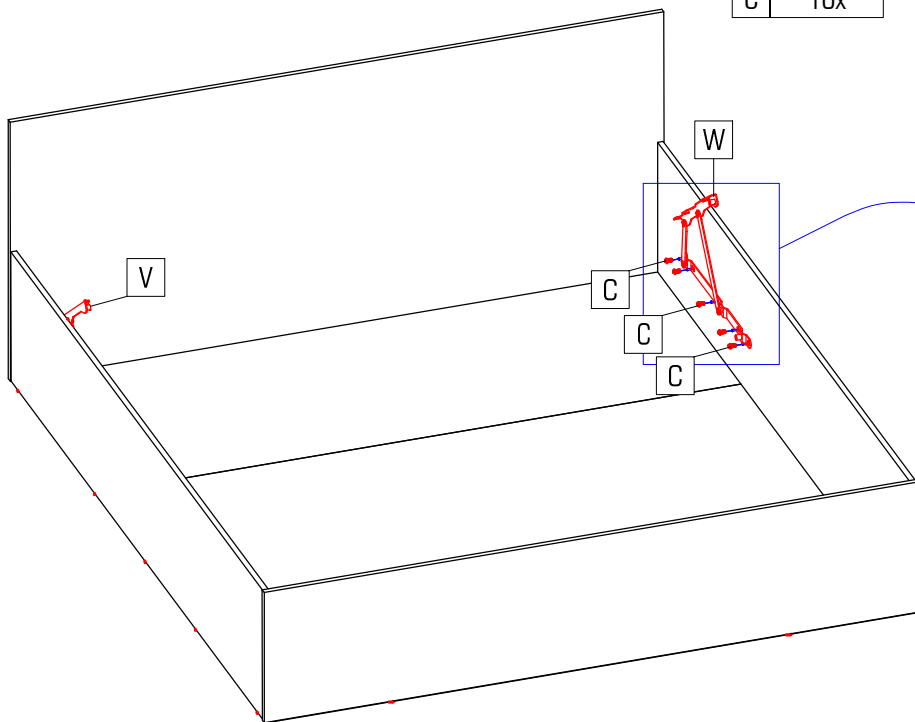
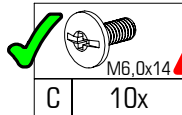
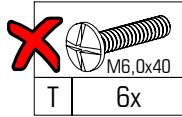





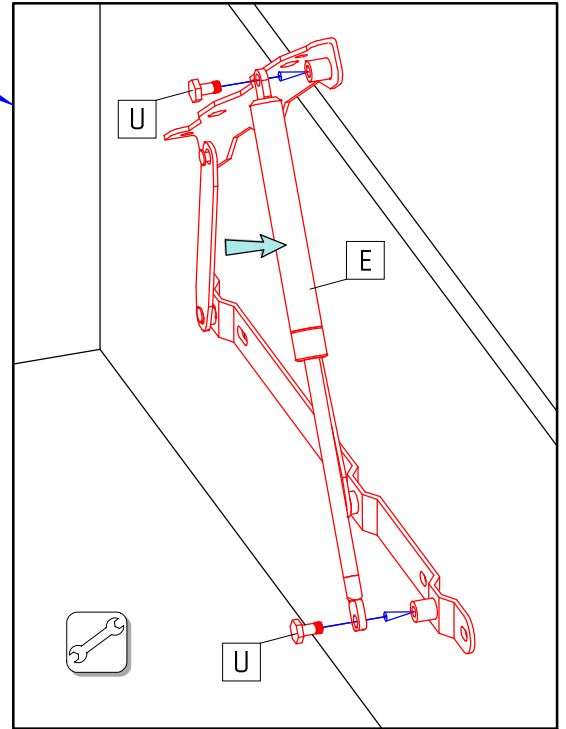
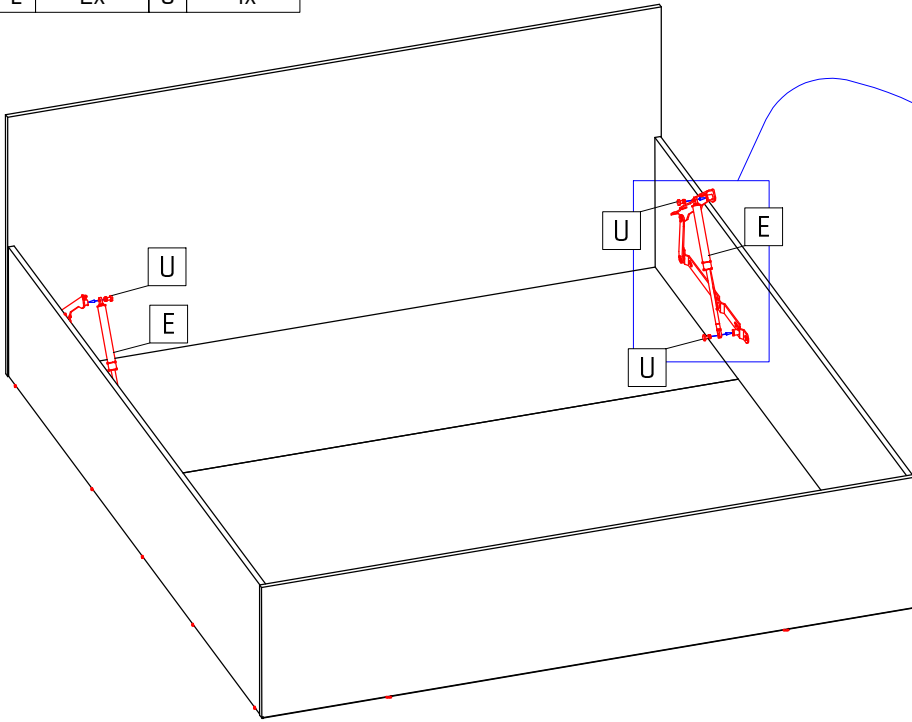

		
C 10x	V 1x	W 1x



DOLI 180x200 5/6

	1000 N		
E	2x	U	4x



													
F	2x	G	1x	H	1x	S	2x	T	1x	X	1x	Y	1x
				M6,0x40	M6,0	M8,0x40							

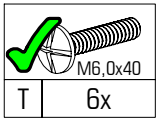

T 6x

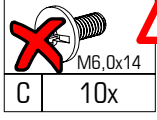

C 10x

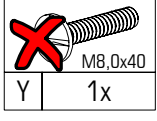

Y 1x

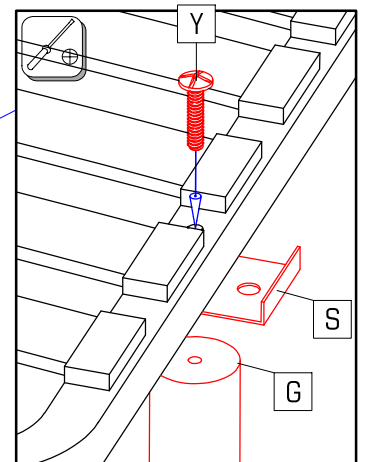
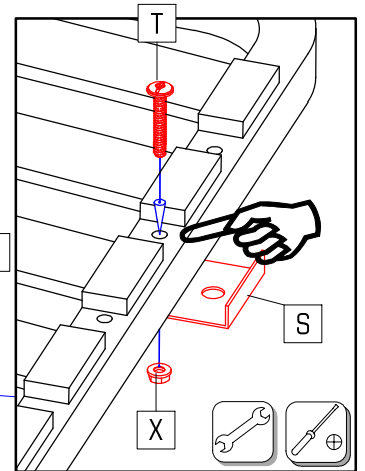
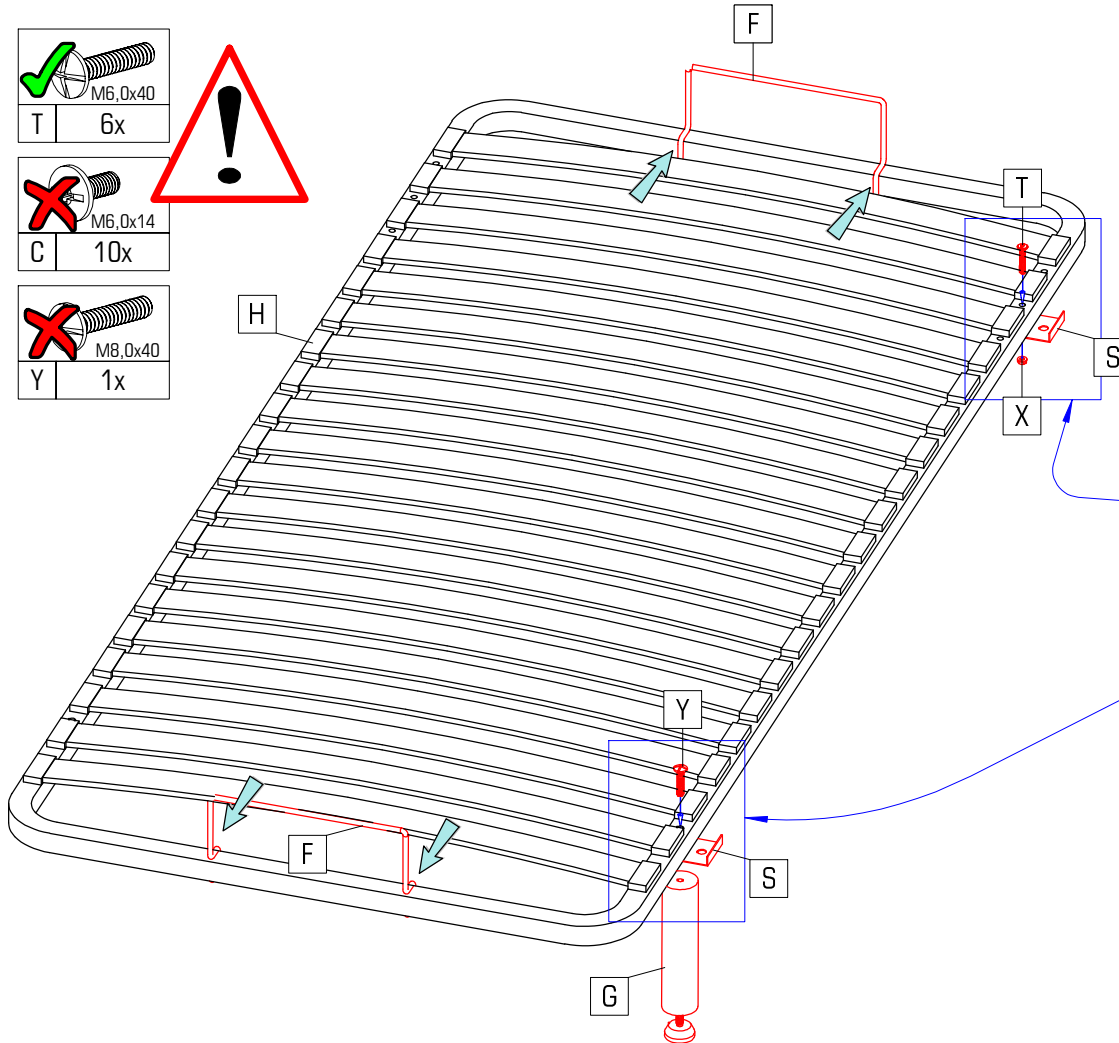

6/6 DOLI 180x200

