

DOLI 120x200

Art.-Nr.

398 680
398 681
398 682
398 686

1236
787
2032
mm

1/6
VO
36-2024

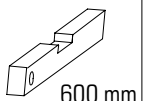
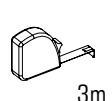
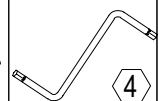
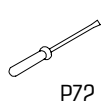
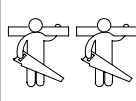

120 min

PZ2

4

0,5 kg

3m

600 mm

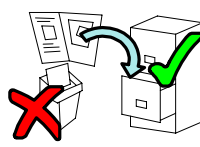
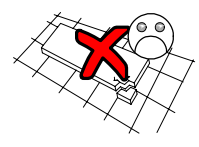
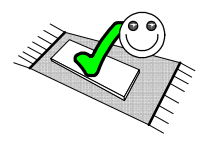
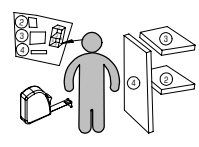
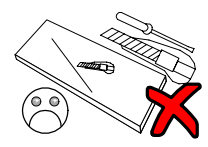
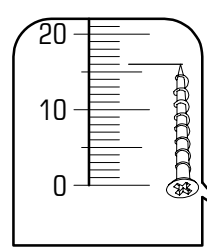
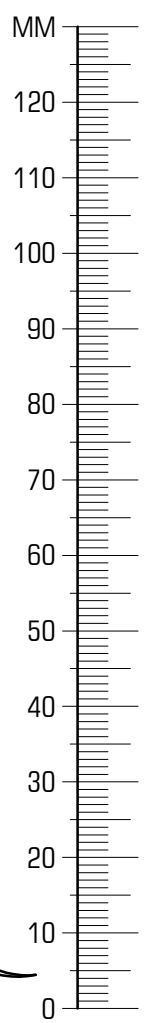
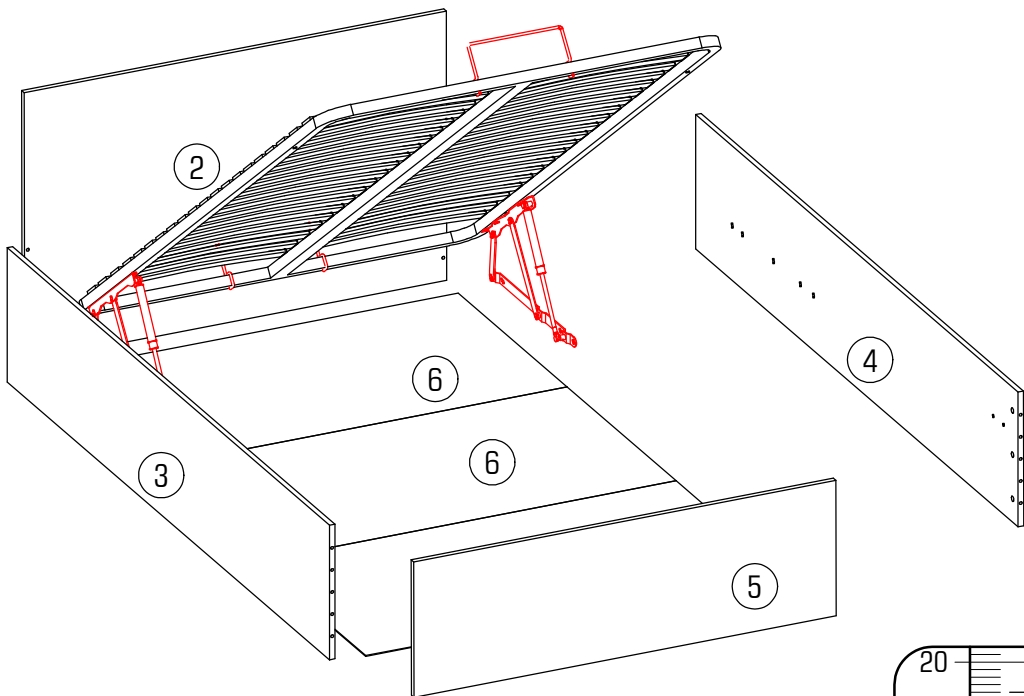
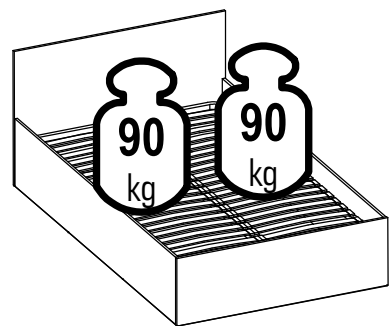

ID	ID			
21599	②	1236*780*16	1x	1/4
21587	③	2000*390*16	1x	2/4
21588	④	2000*390*16	1x	2/4
21600	⑤	1236*392*16	1x	1/4
21601	⑥	676*1228*3	3x	1/4
			1x	3/4
			1x	4/4



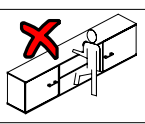
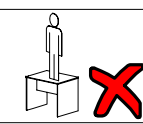
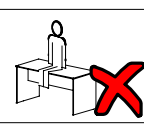
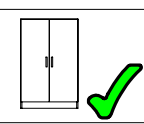
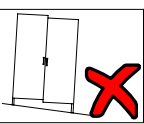
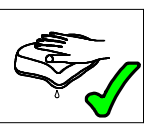
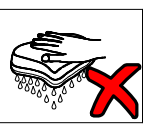
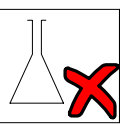

21102,00		Ø1,6x20	22205,02		Ø5,0x16	22510,00		M6,0x14	22300,00		Ø7x50	37148,00		1000 N	37147,00			37151,00	
A	100x		B	8x		C	10x		D	6x		E	2x		F	2x		H	1x
22800,01		4	24091,00		Ø10x11	27000,00		Ø8x30	30091,00		10x	70013,01		Ø15x13	70021,01				
J	1x		K	10x		L	8x		M	10x		N	6x		P	6x		Q1	6x
		6x	31106,00			37148,00		M6,0x40	37148,00		4x	37148,00		1x	37148,00		1x	37148,00	
Q2	6x		R	2x		T	4x		U	4x		V	1x		W	1x		X	4x

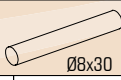

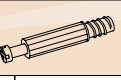
2/6 DOLI 120x200

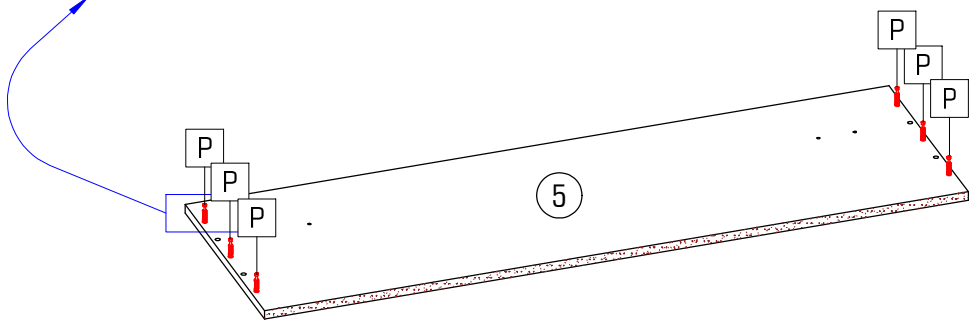
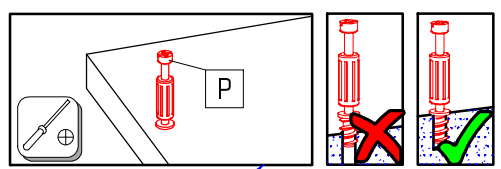
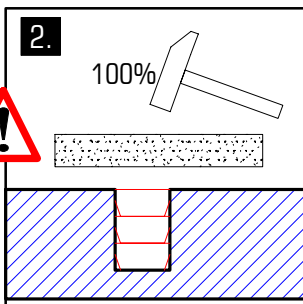
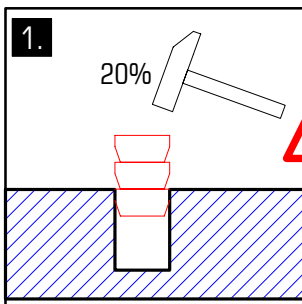
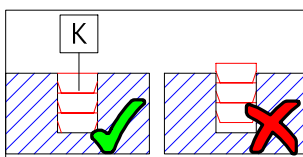
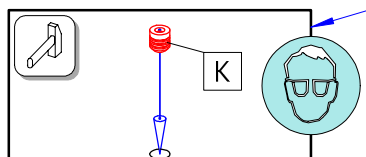
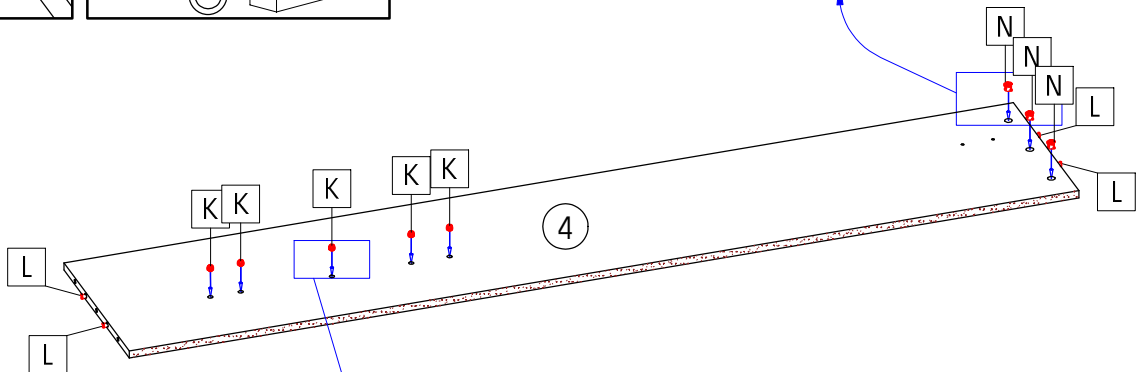
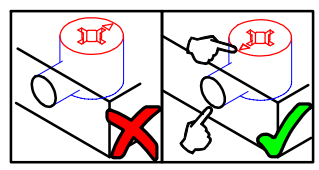
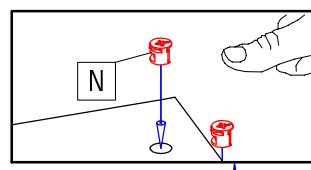
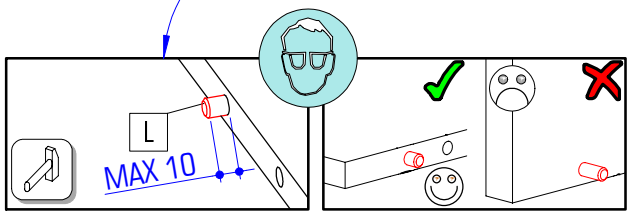
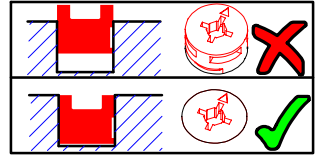
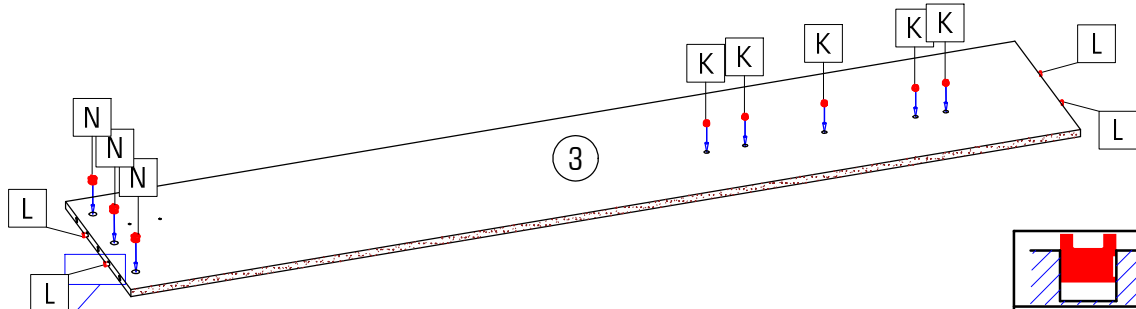
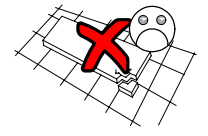
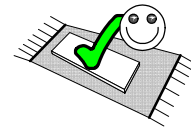

			
Ø10x11	Ø8x30	Ø15x13	
K 10x	L 8x	N 6x	P 6x

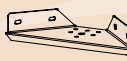

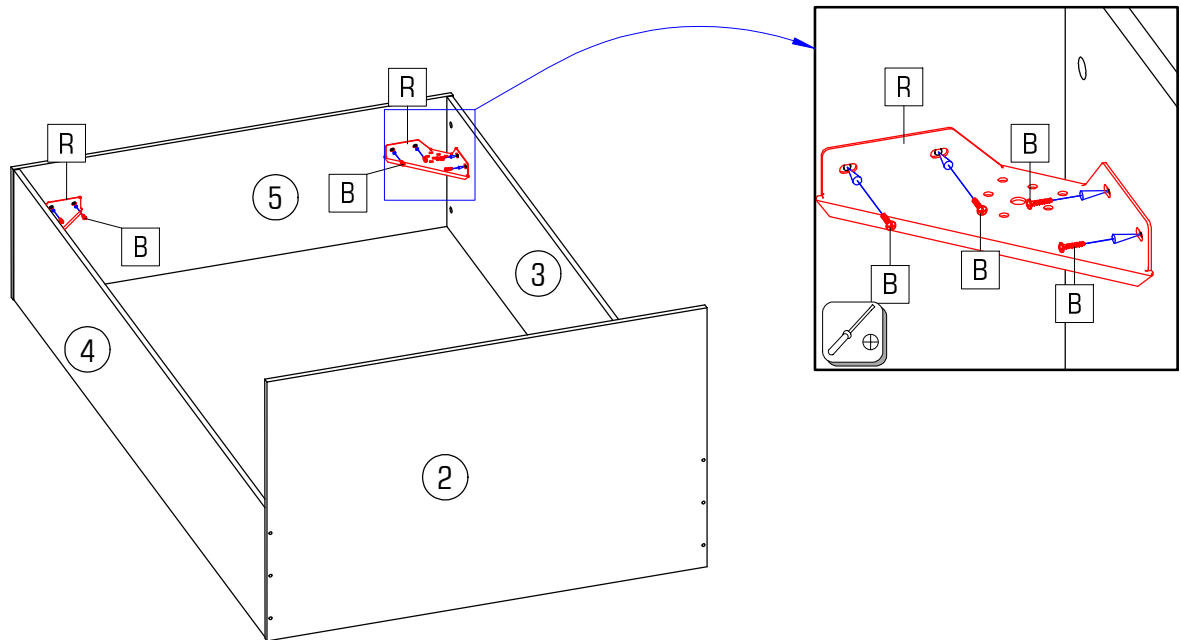
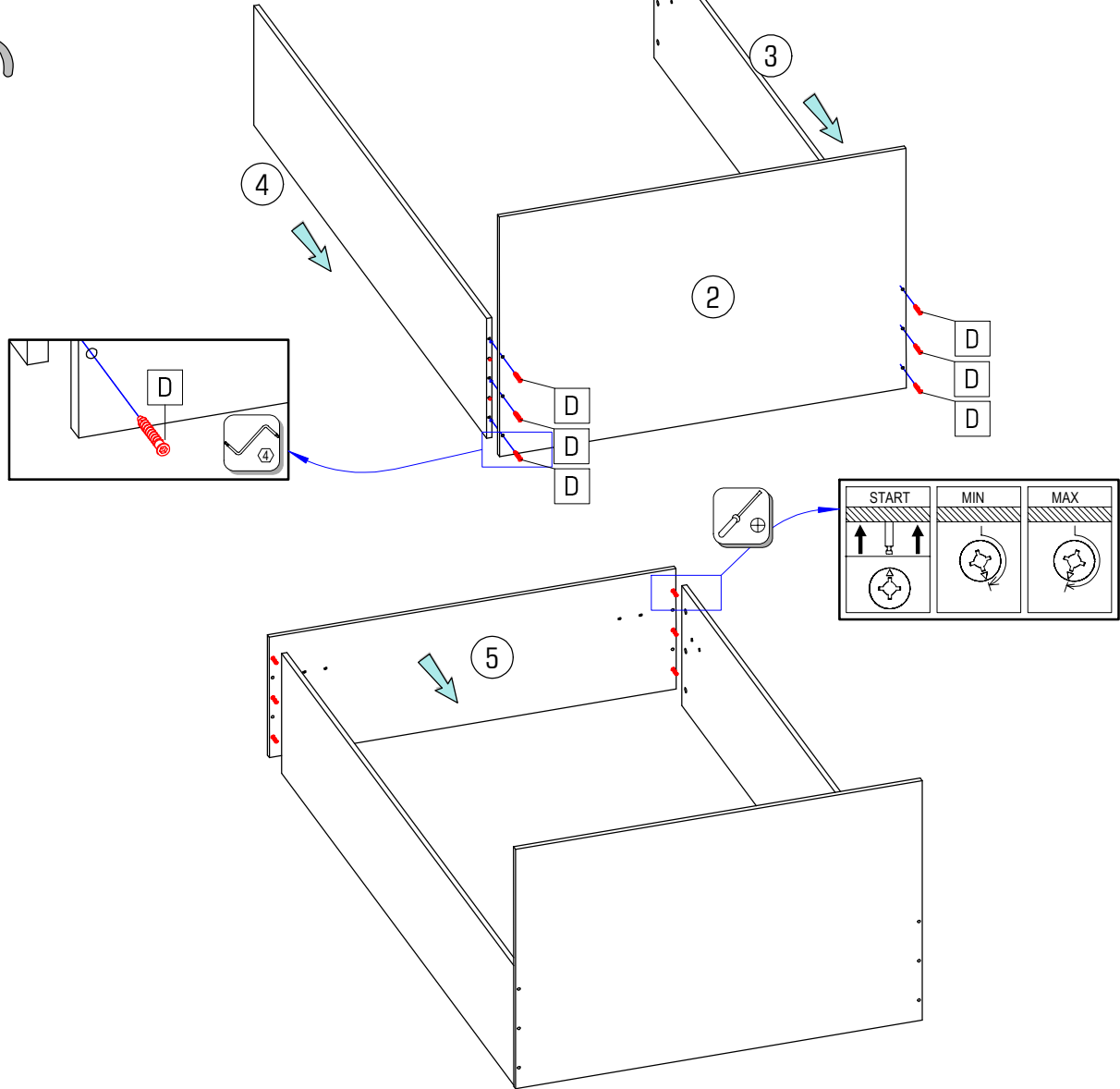
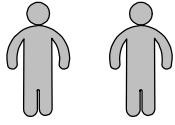
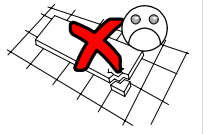
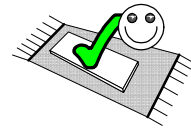

		
Ø5,0x16	Ø7x50	
B 8x	D 6x	R 2x

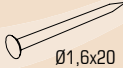

4/6 DOLI 120x200

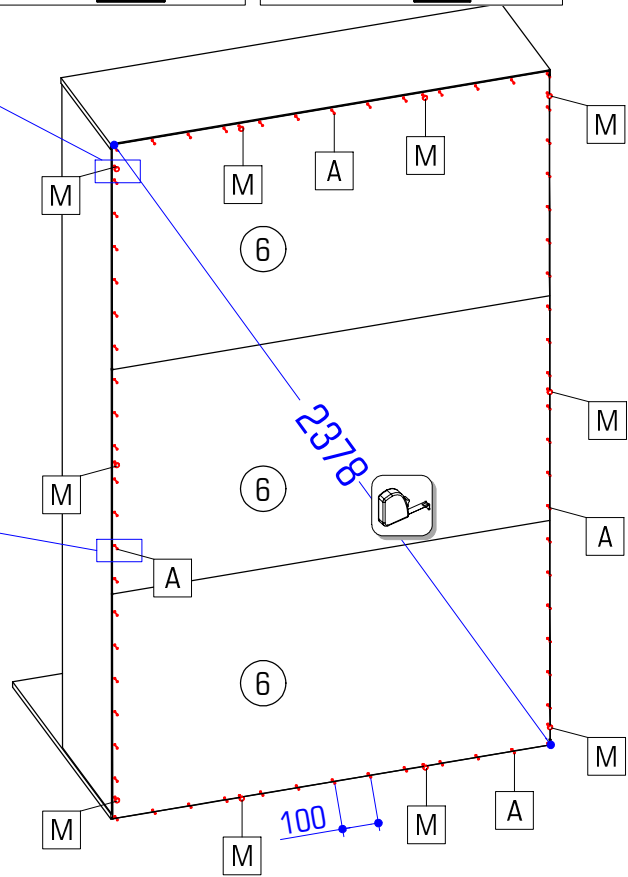
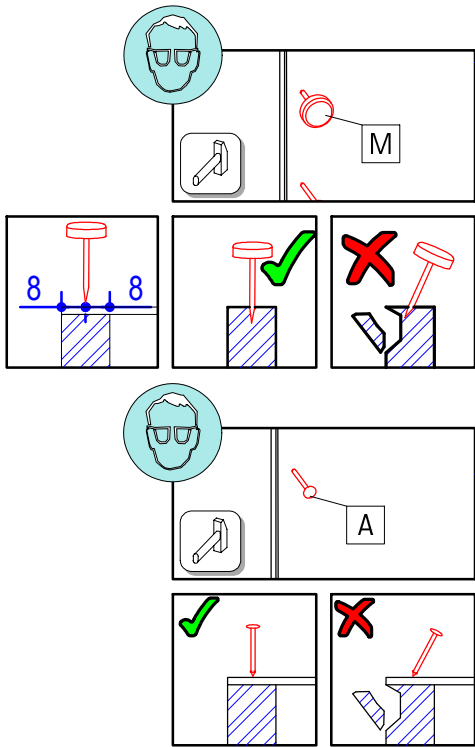
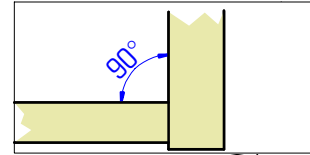
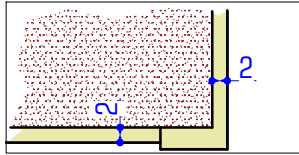
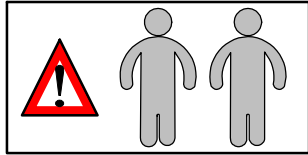

	
A 100x	M 10x

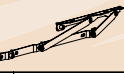
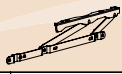

		
C 10x	V 1x	W 1x

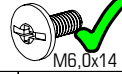
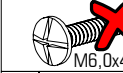



	
C 10x	T 4x

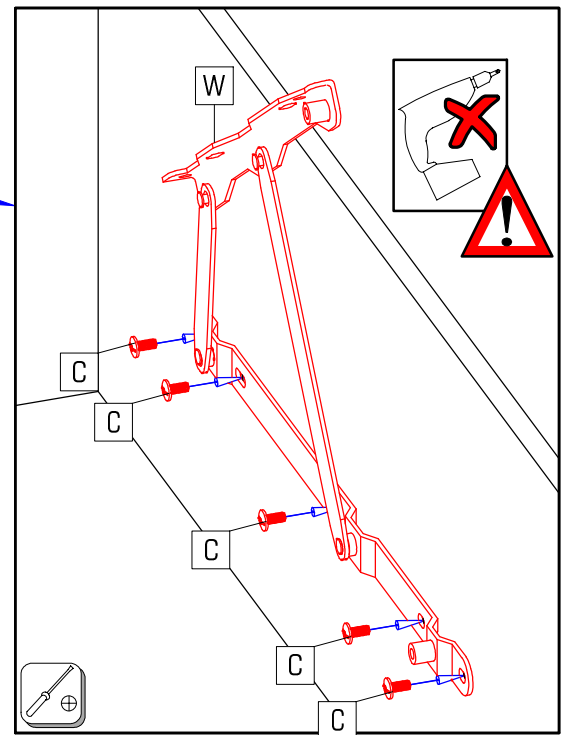
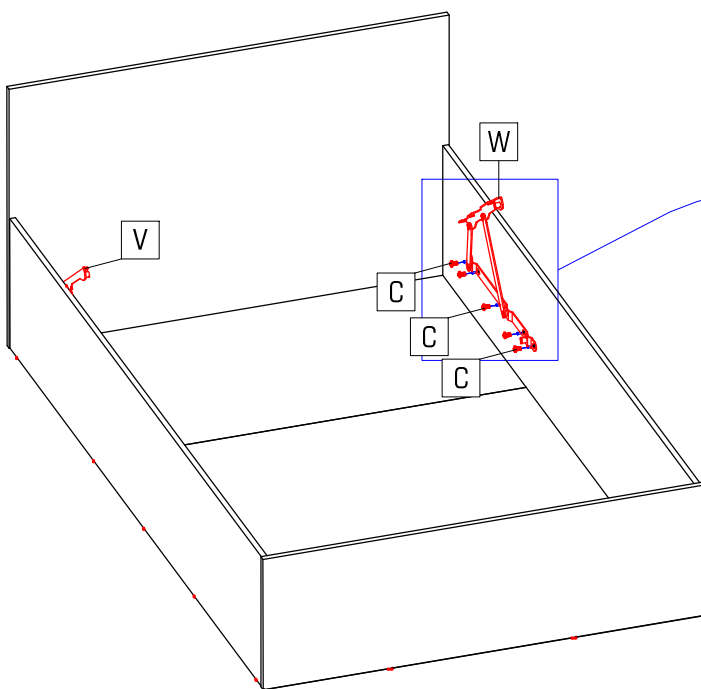

	
T 4x	

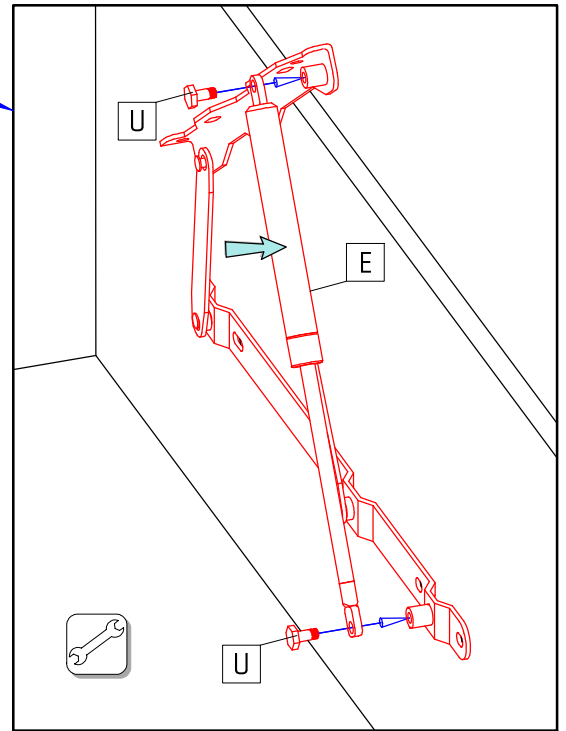
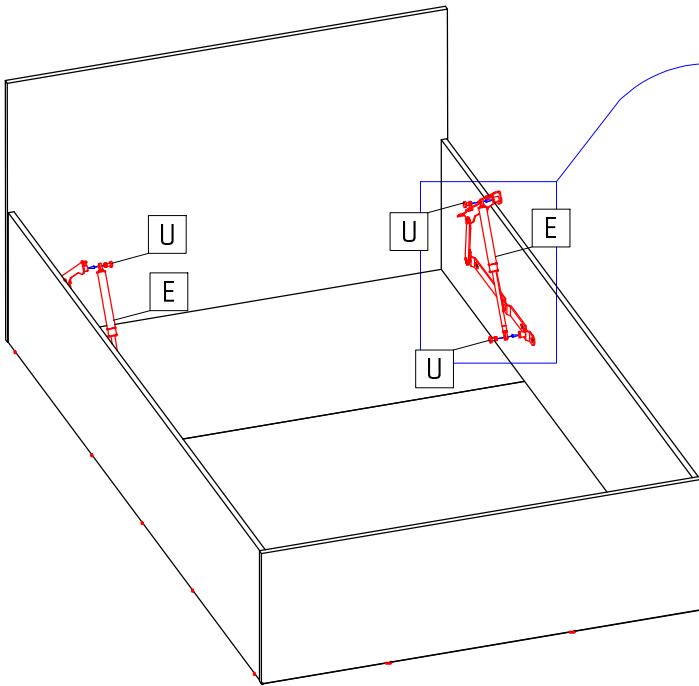

DOLI 120x200 5/6

	
1000 N	
E 2x	U 4x



	
F 2x	H 1x

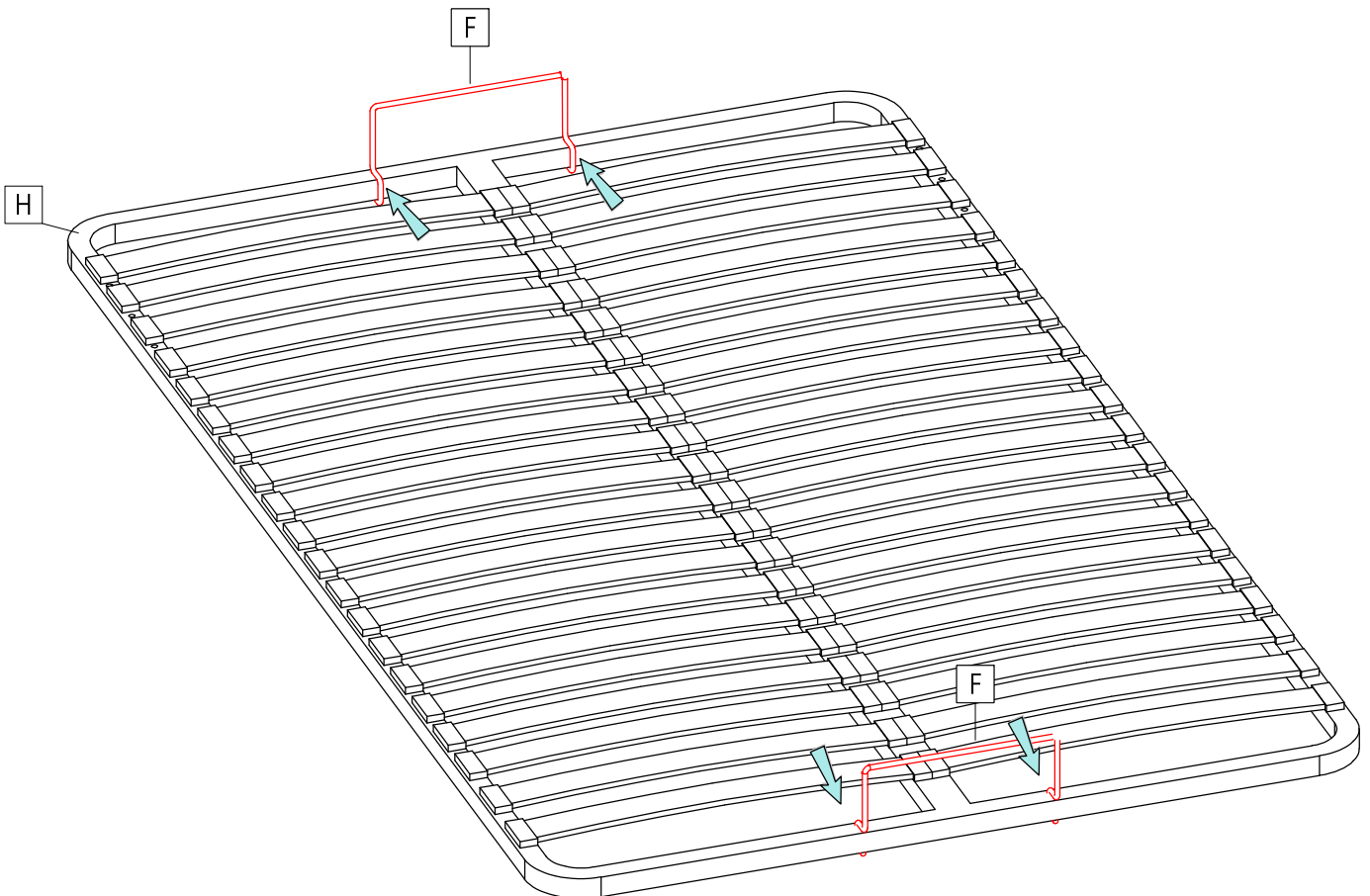

6/6 DOLI 120x200

Q1	6x	Q2	6x
T	4x	X	4x
	M6,0x40		M6,0

