

DOLINS

Art.-Nr.

398 671
398 673
398 674
398 675

400
400
400
mm

1/4
VO
36-2024

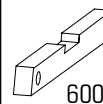
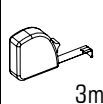
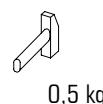
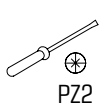
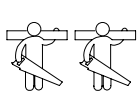



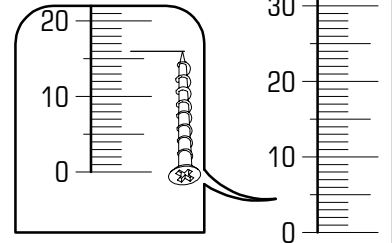
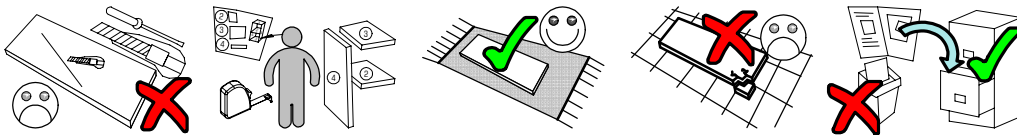
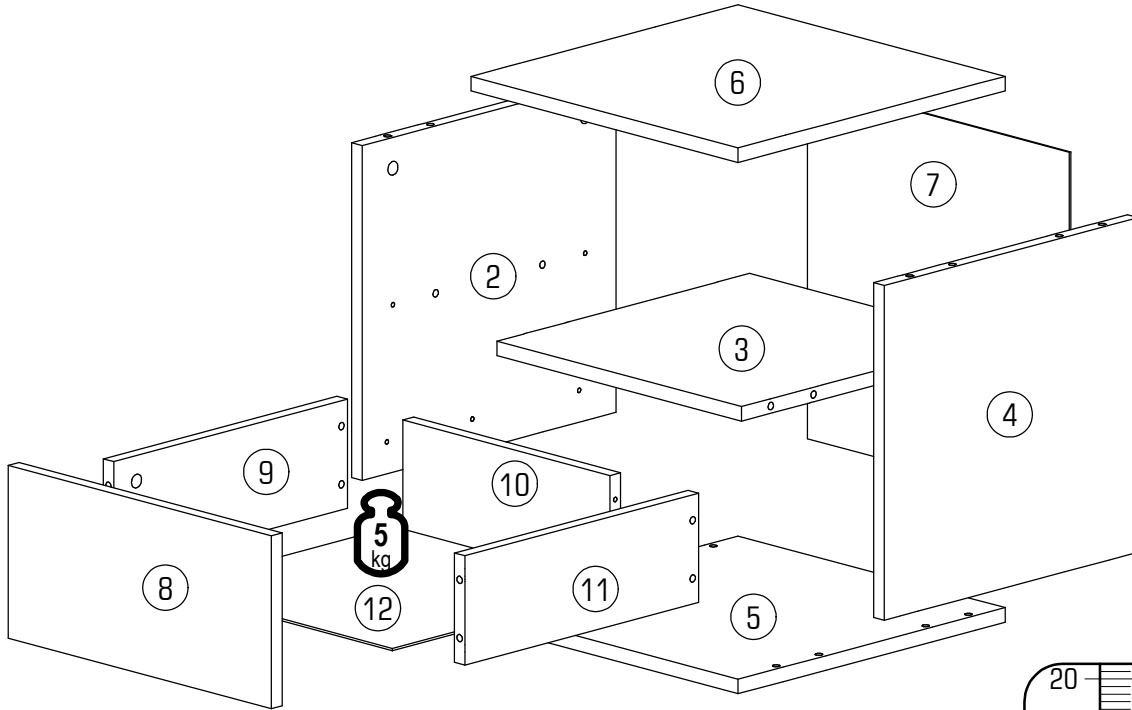
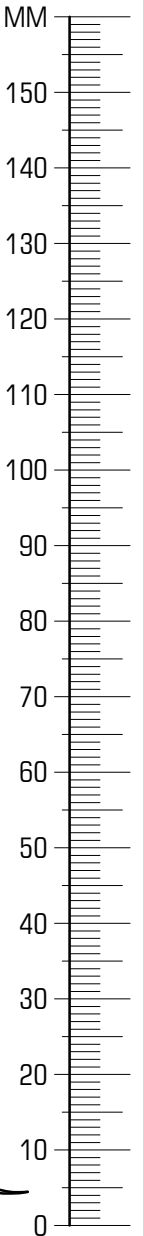
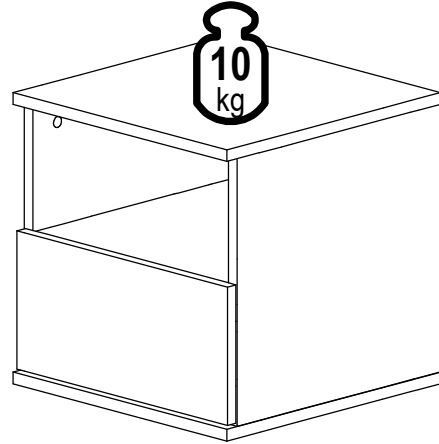

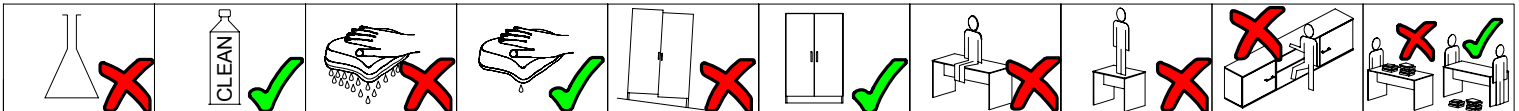

ID	ID			
21626	②	368*380*16	1x	1/1
21627	③	366*378*16	1x	1/1
21628	④	368*380*16	1x	1/1
21629	⑤	400*400*16	1x	1/1
21630	⑥	400*400*16	1x	1/1
21631	⑦	392*392*3	1x	1/1
21632	⑧	394*190*16	1x	1/1
19025	⑨	350*120*16	1x	1/1
21633	⑩	310*120*16	1x	1/1
19027	⑪	350*120*16	1x	1/1
21634	⑫	356*340*3	1x	1/1



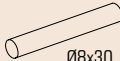

27000.00		22300.00		22800.01		22244.01		22243.00		22705.00		34800.00	
A	12x	B	8x	C	1x	D	3x	E	8x	F	6x	G	4x
21102.00		33006.01		70013.01		70021.01				33006.01			
H	25x	J	1x	K	12x	L	12x	M	8x	N	1x		

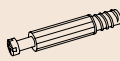

2/4 DOLINS

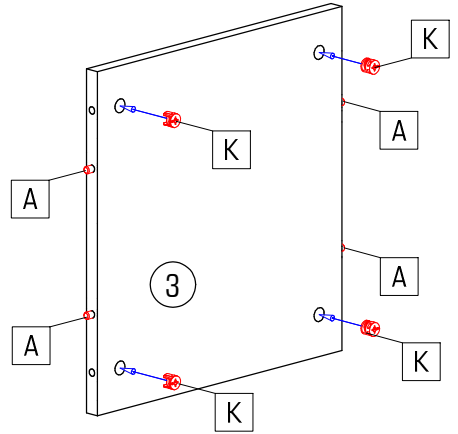
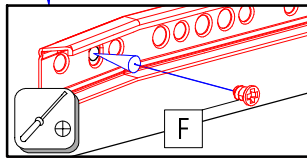
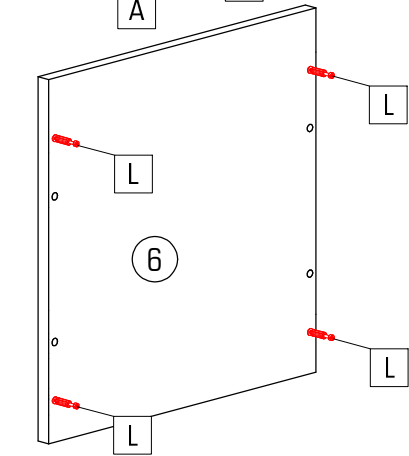
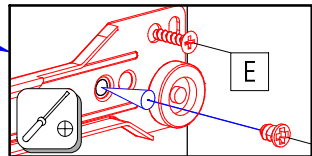
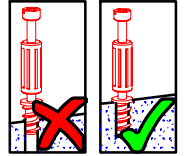
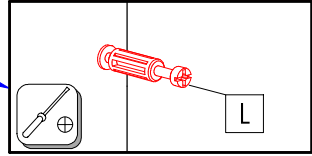
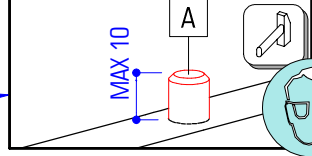
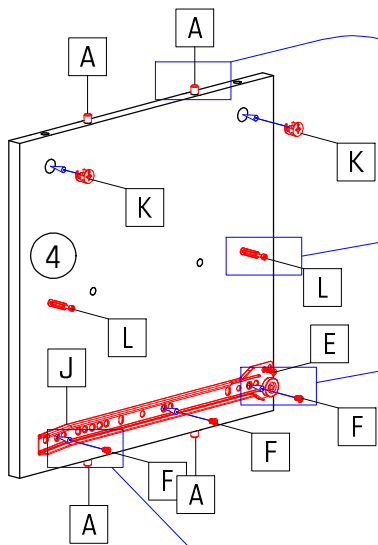
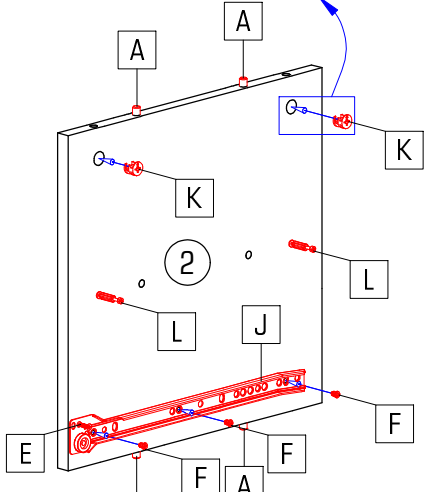
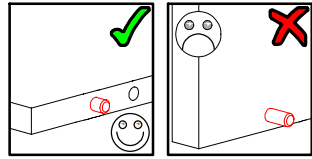
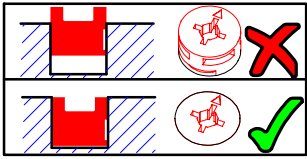
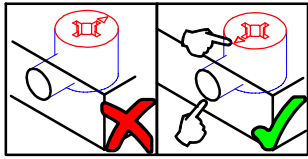
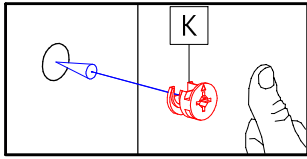
					
A 12x	E 2x	F 6x	K 8x	L 8x	J 1x



B 4x

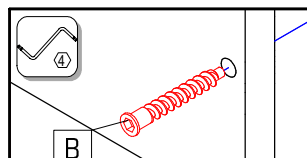
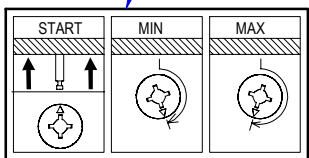
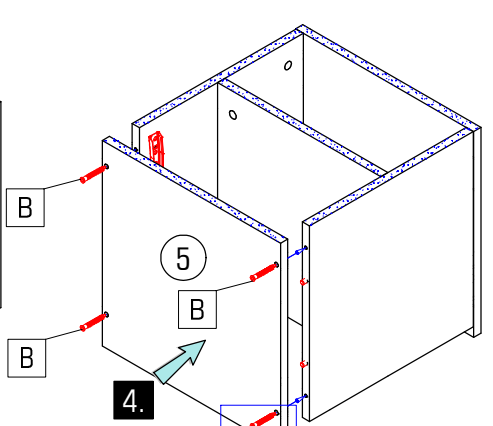
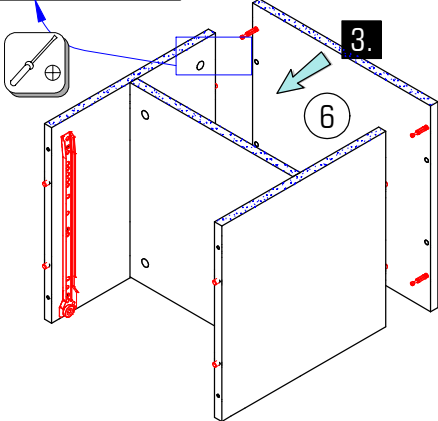
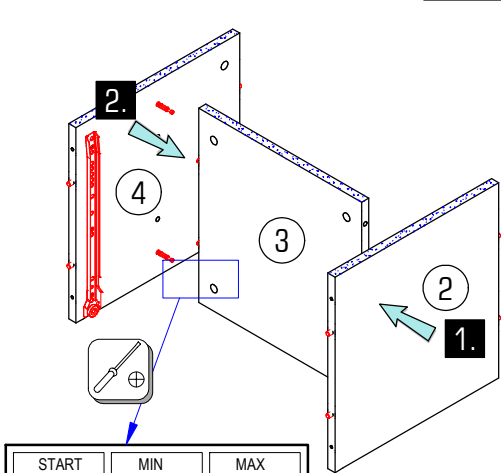
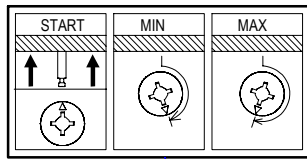

4/4 DOLINS



M

4x

