

60 LO-2100

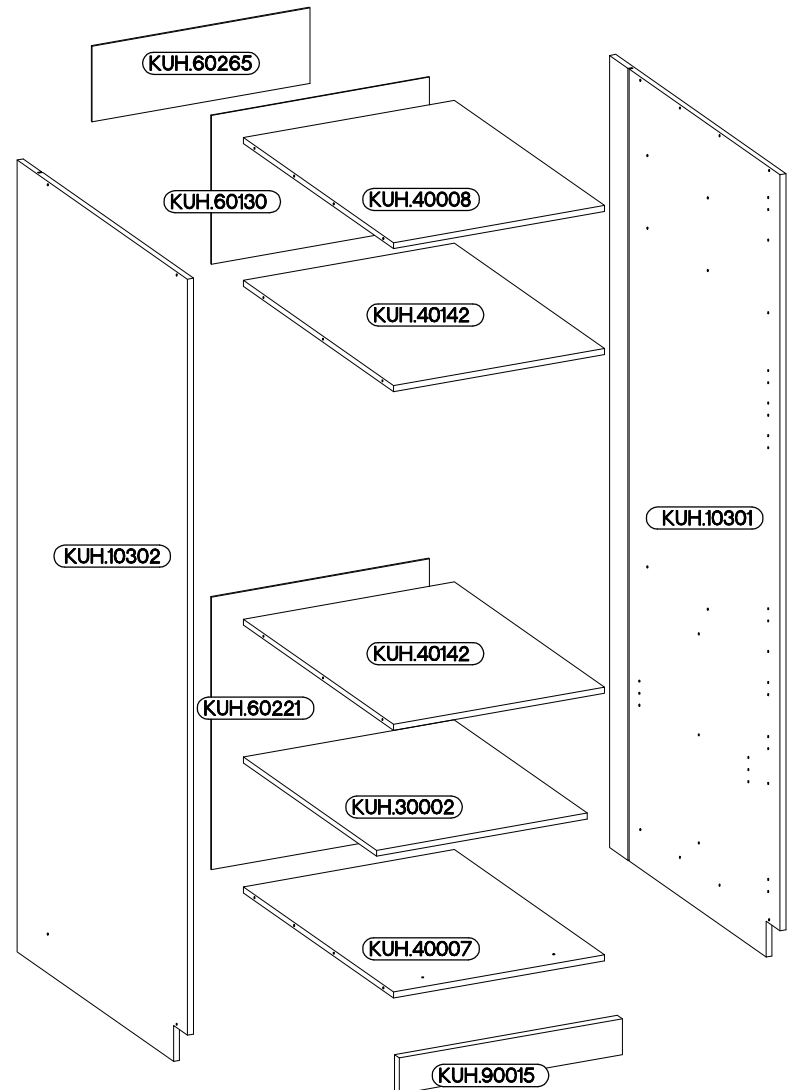

Ersatzteil Nummer	Dimension
KUH.10301	2095x550x16
KUH.10302	2095x550x16
KUH.30002	566x430x16
KUH.40007	567x485x16
KUH.40008	567x485x16
KUH.40142 x2	567x485x16
KUH.60130	393x585x2,5
KUH.60221	721x585x2,5
KUH.60265	200x585x2,5
KUH.90015	599x95x16

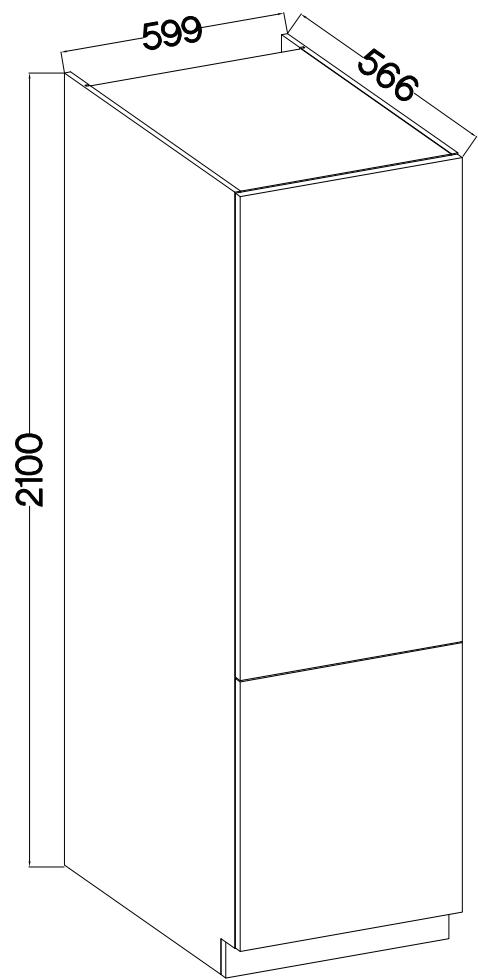
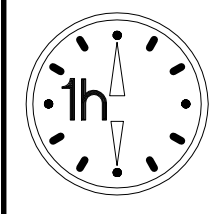
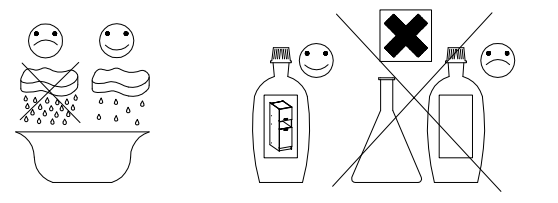
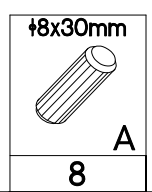
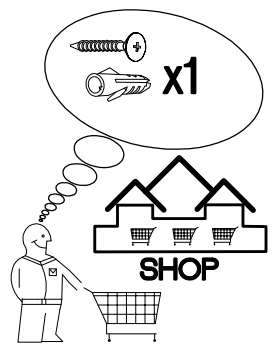

B 8	C 12	D2 12	E 12	E1 8	E9 2	F2 4	HG 5
J 4	L25 1	O 1	P1 16	P4 2	P5 12	P7 15-20	T4 4
6,4 x 50mm	15/12mm	L=20mm	4.0x16mm	4.0x45mm	3.5x13mm	3.0x20mm	6.5x48x16
15/19mm							35/0mm

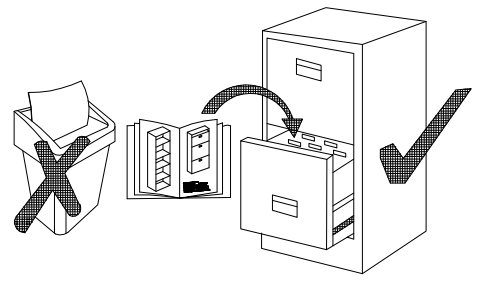

ISM-KUH-01148

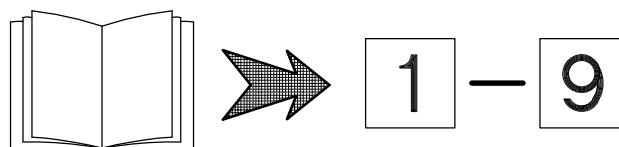
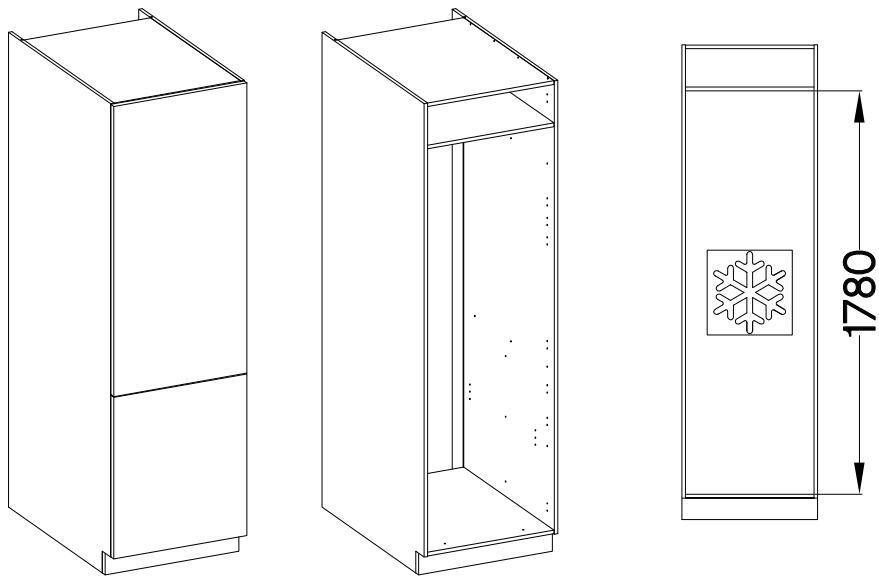



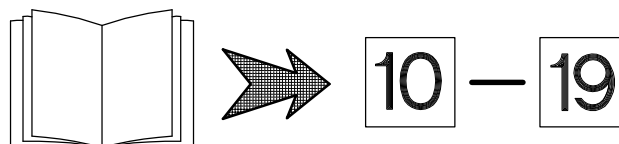
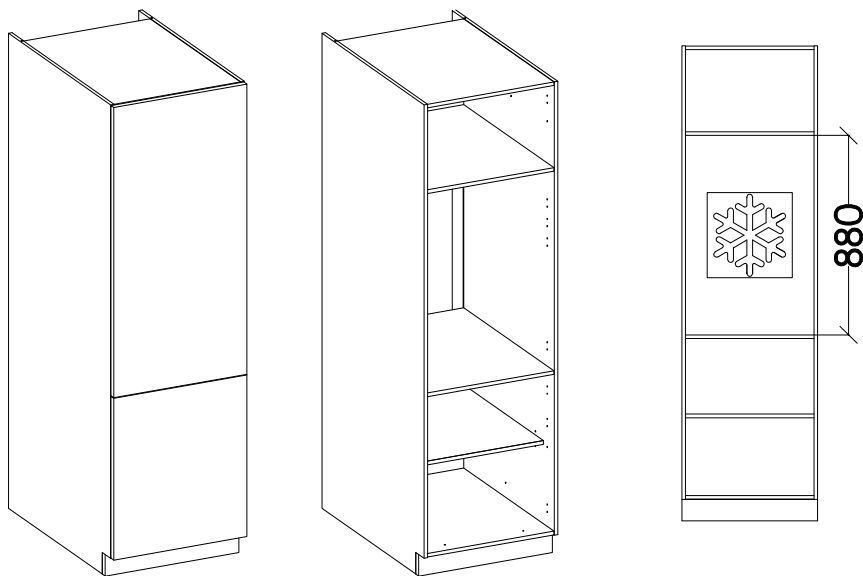

WARIANT B

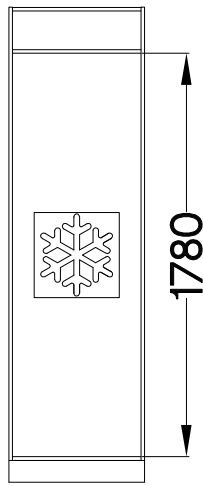
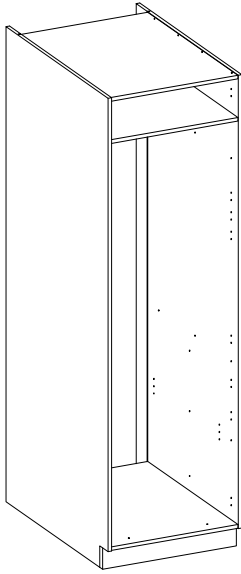

1

WARIANT A



$\varnothing 8 \times 30 \text{mm}$  A	$6.5 \times 48 \times 16$  F2
8 L=20mm  D2	4 $\varnothing 15 / 12 \text{mm}$  C
6	6

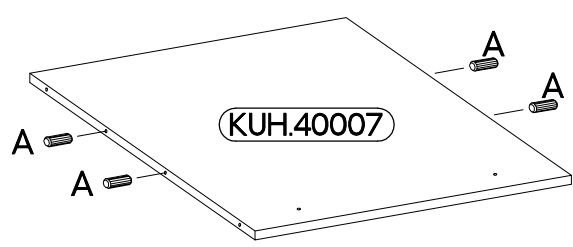
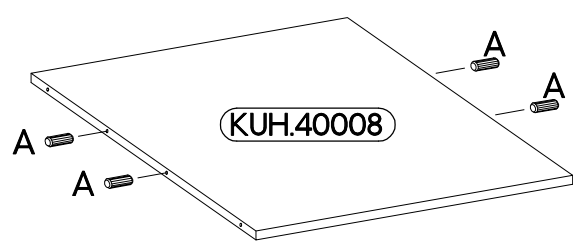
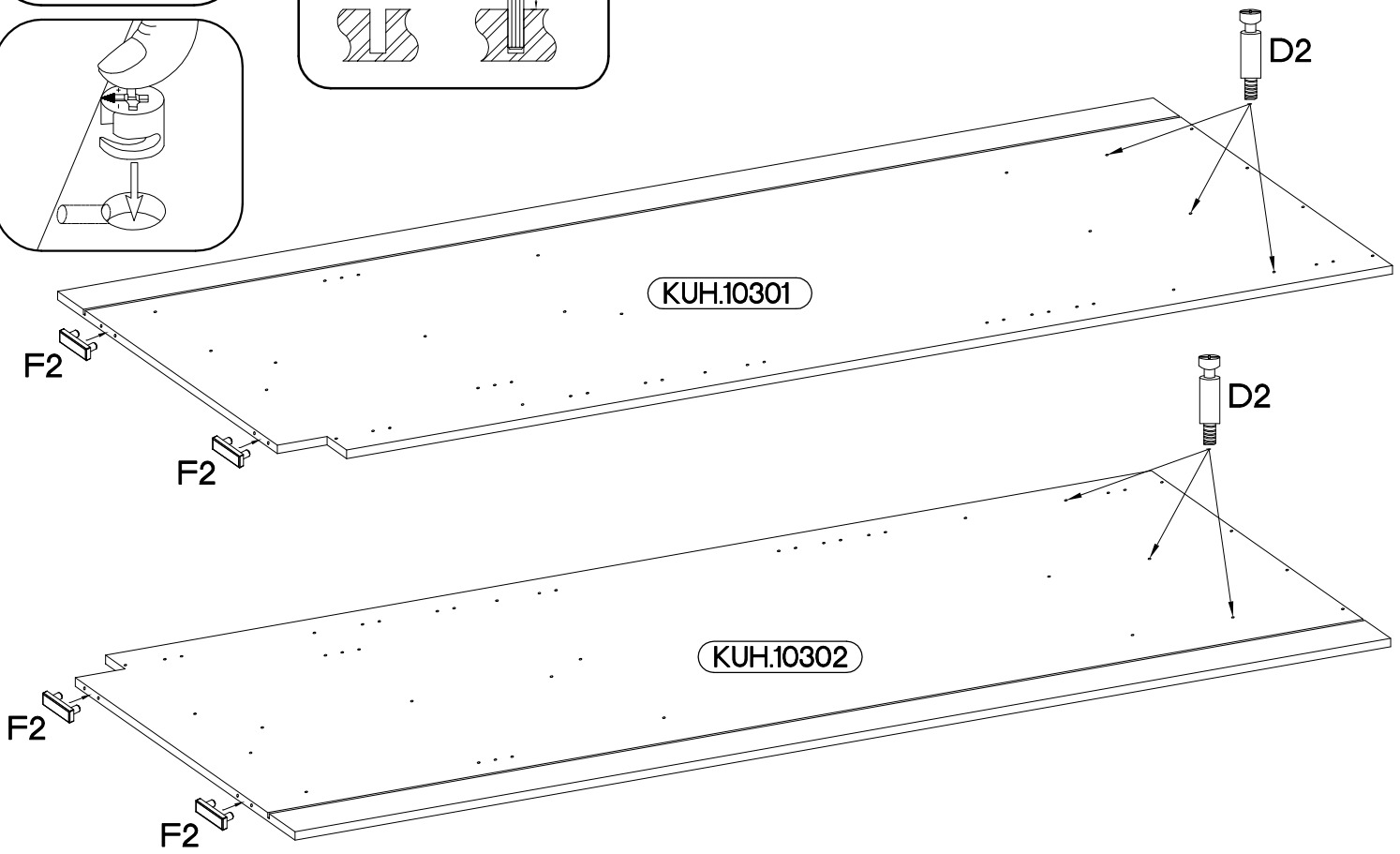
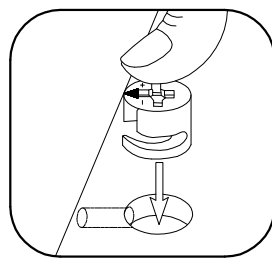
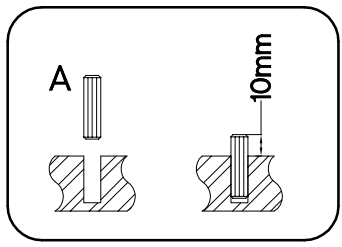
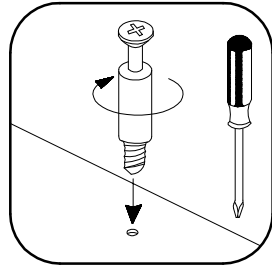
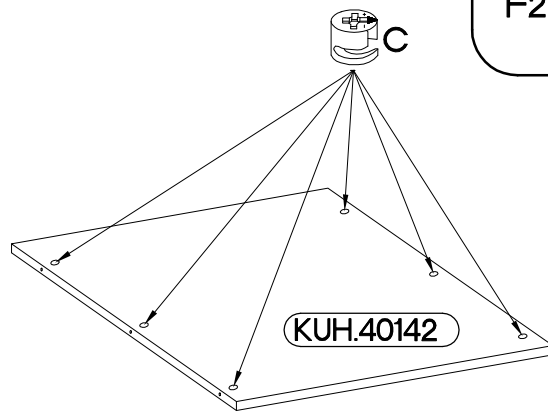
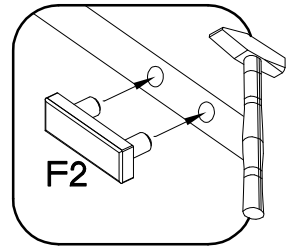
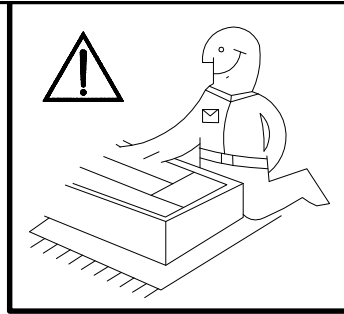

2

6,4 x 50mm

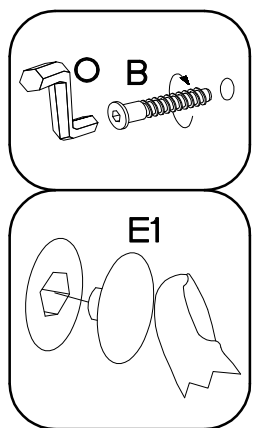
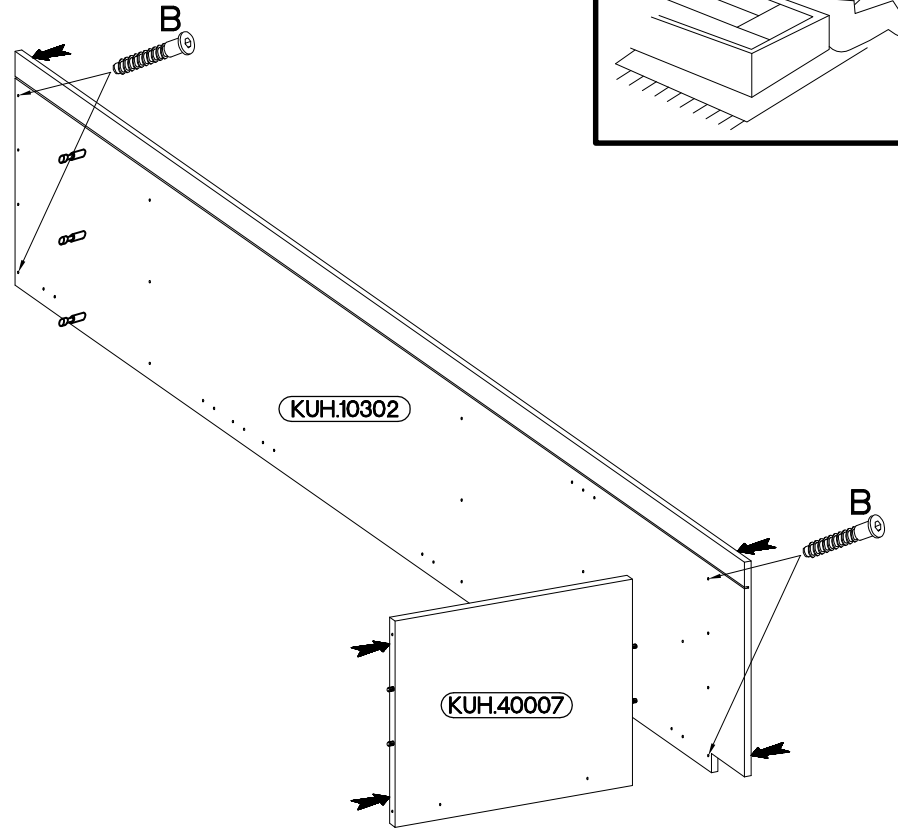
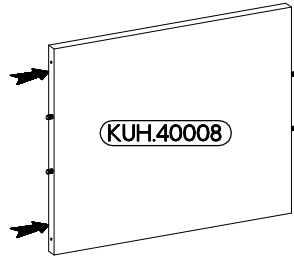
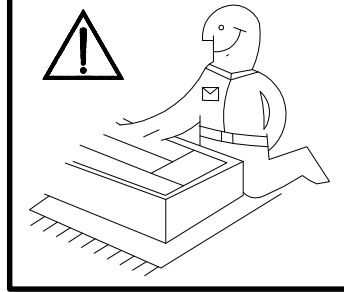
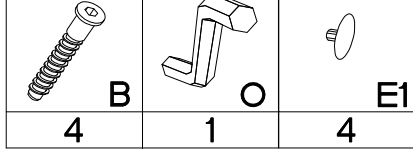



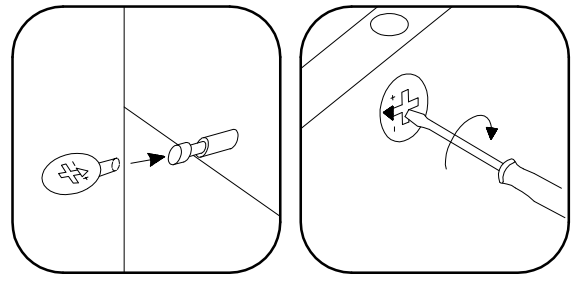
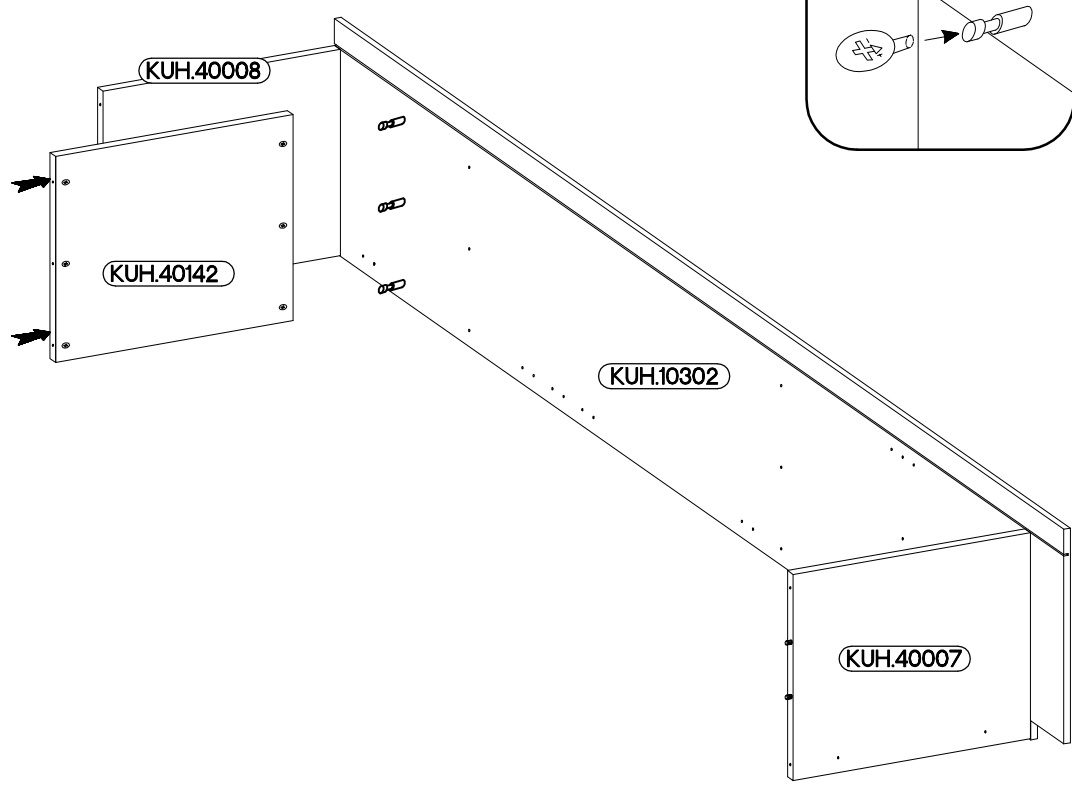

3





4

6,4 x 50mm

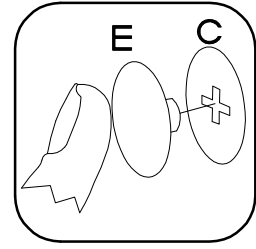
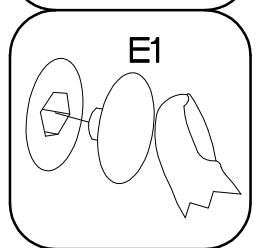
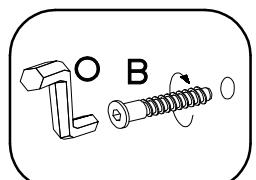
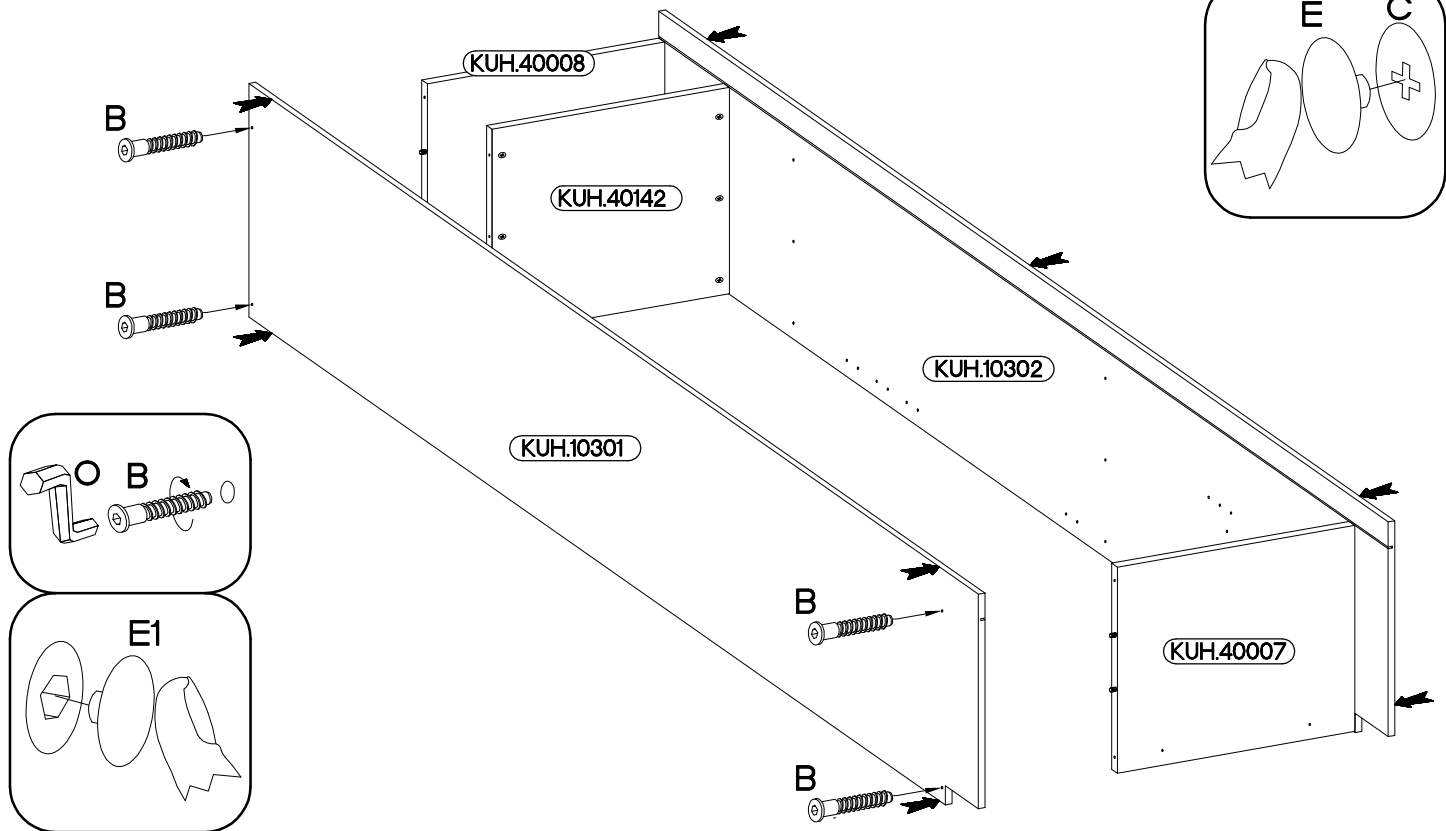
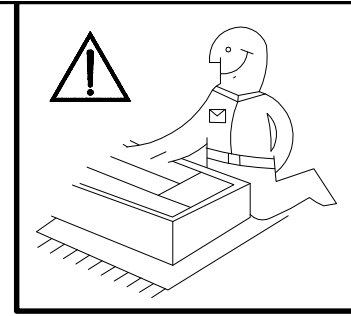
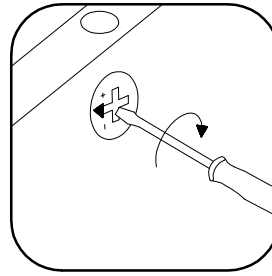
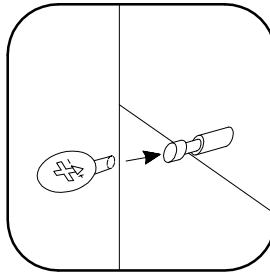
			
B	O	E1	E
4	1	4	6

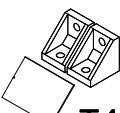

5

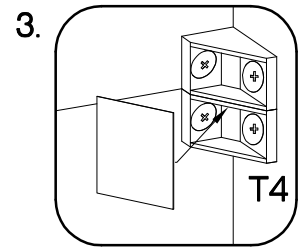
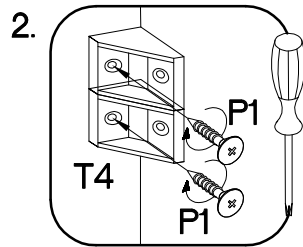
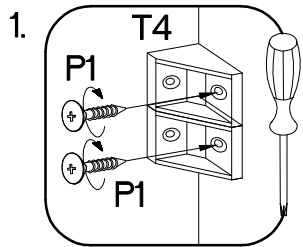
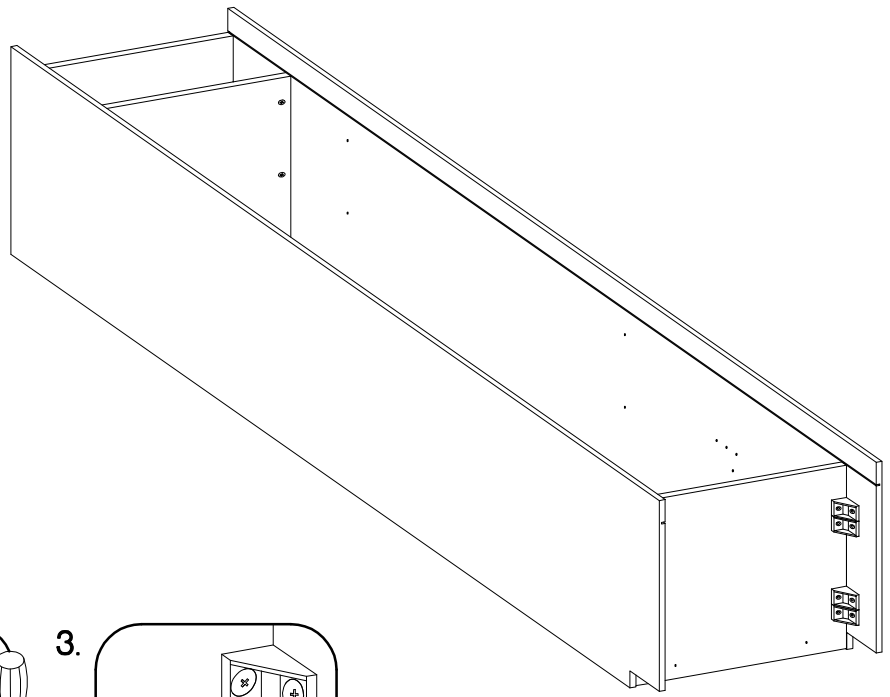
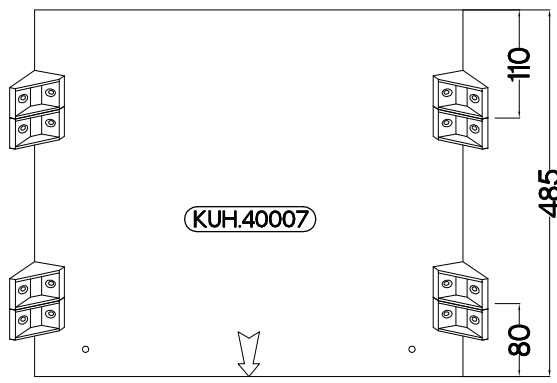

	
T4	P1
4	16

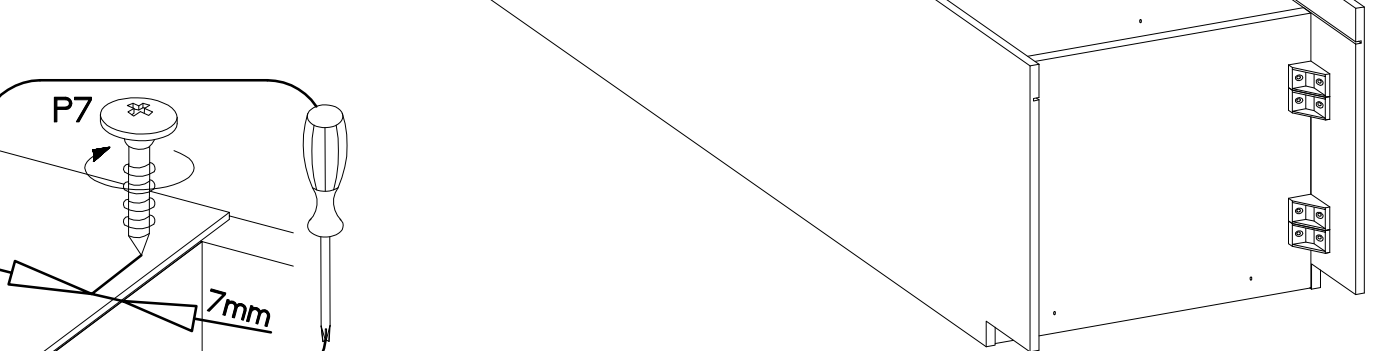
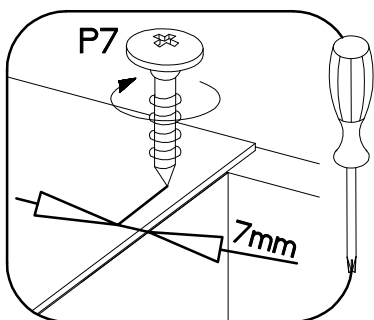
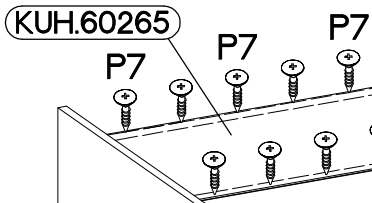
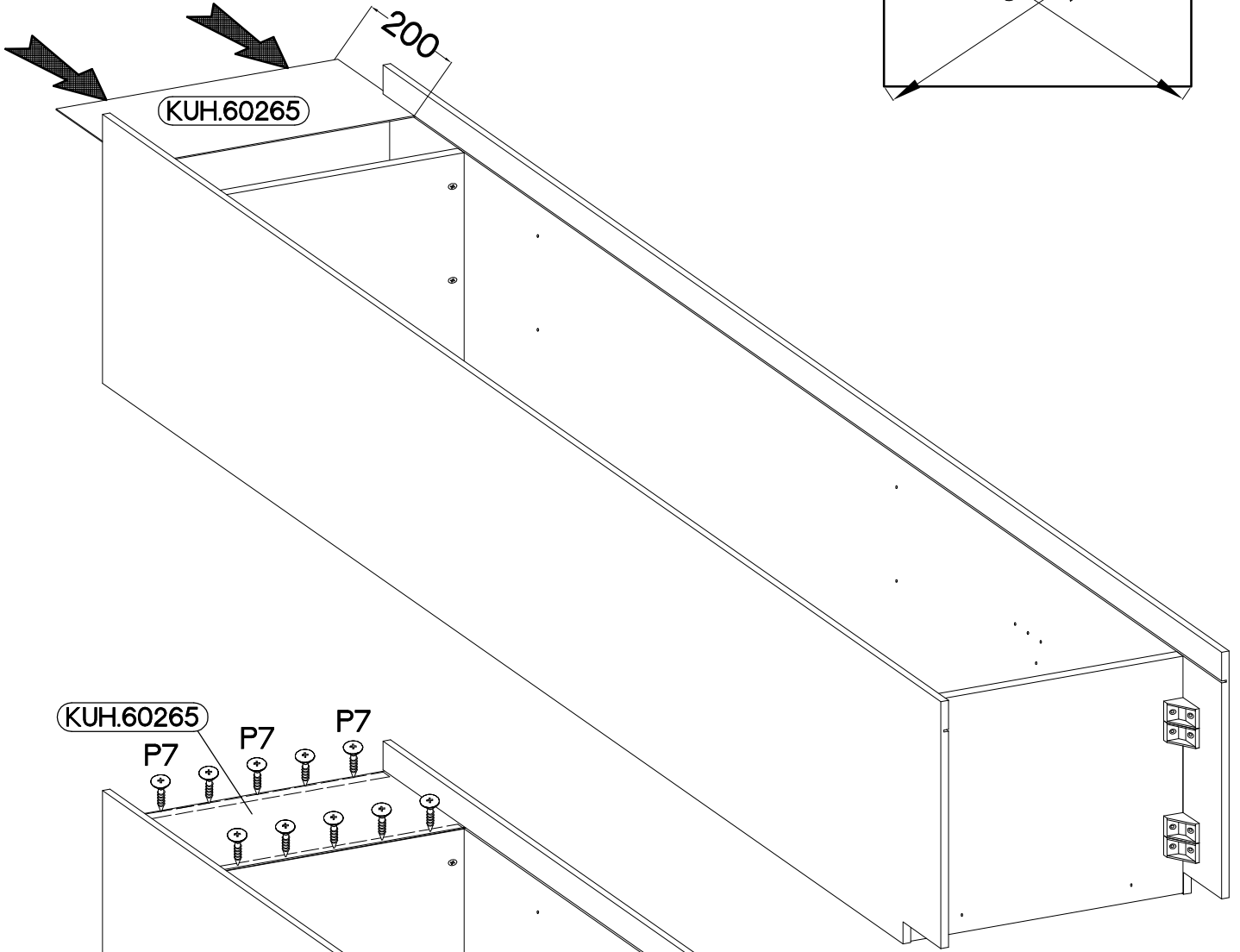
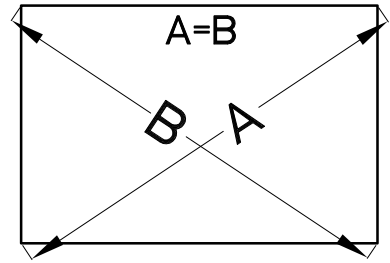

6

φ3.0x20mm
P7
8-10

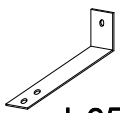

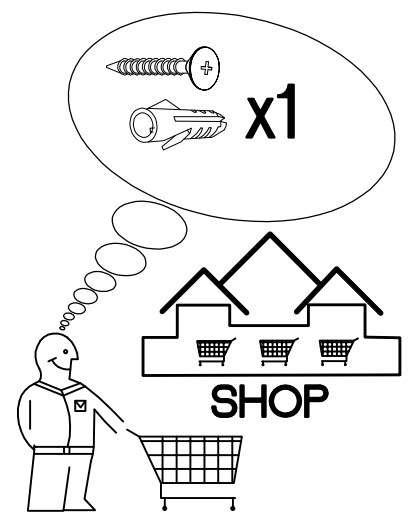
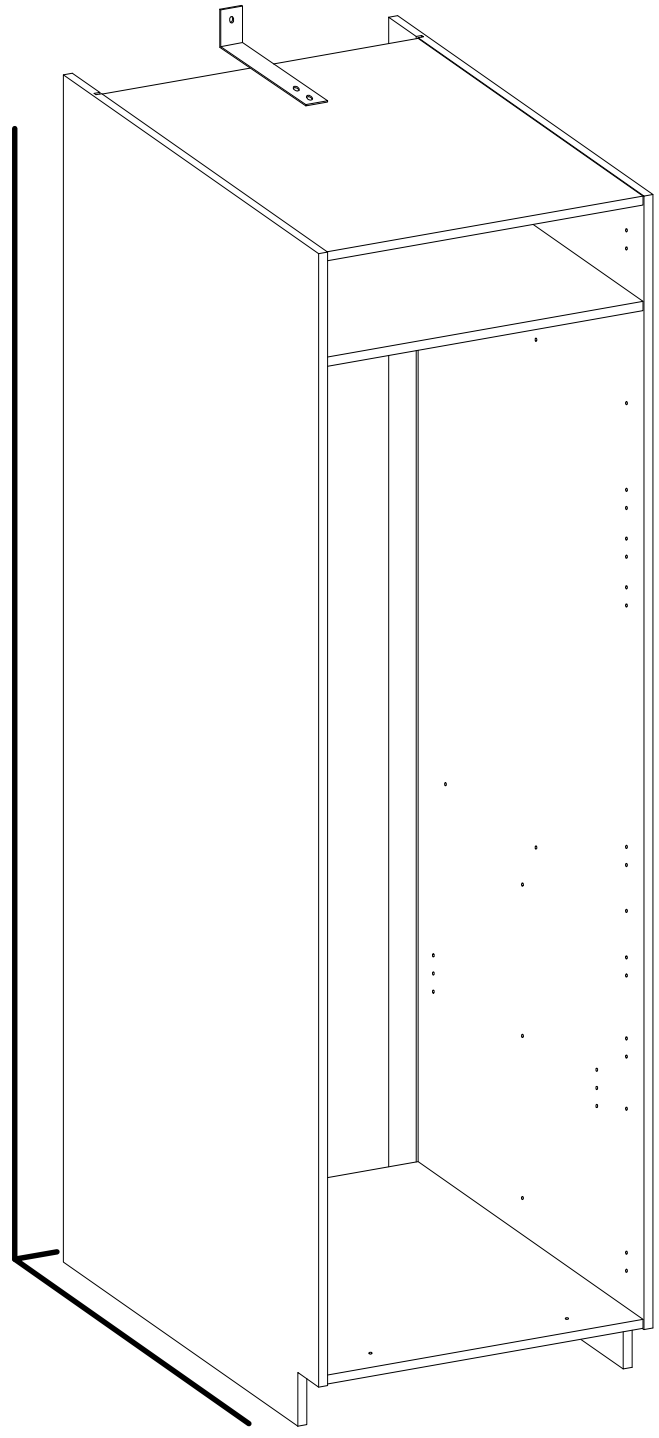
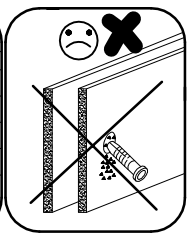
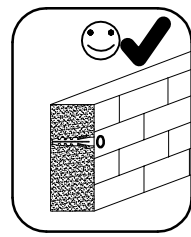
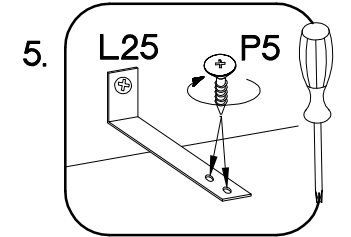
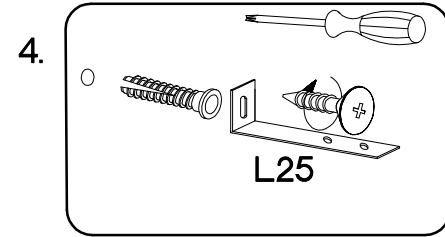
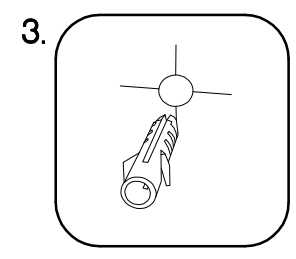
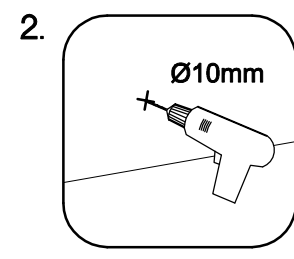
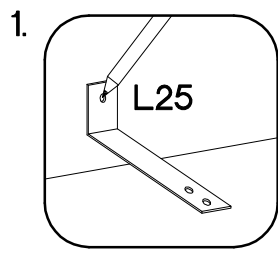

	±3.5x13mm 
L25	P5
1	2

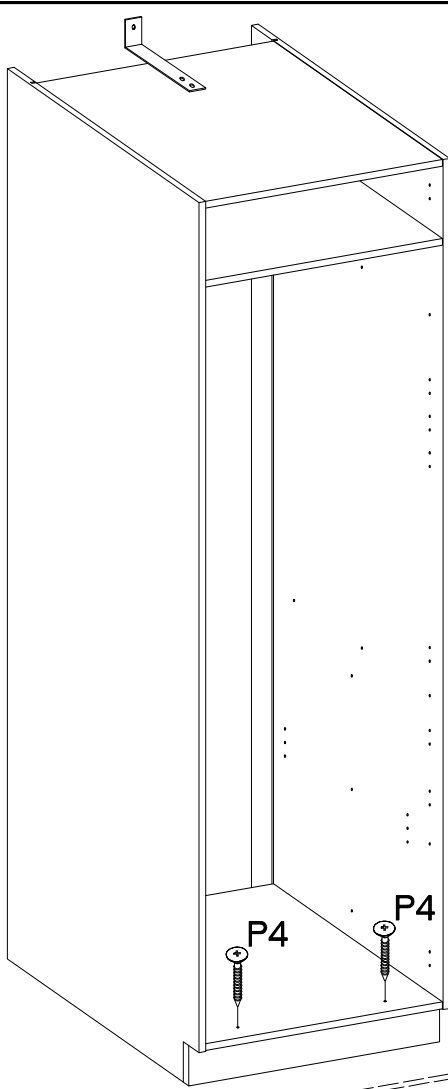

8



4.0x45mm  P4	 E9
2	2

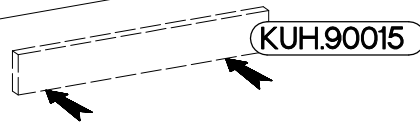
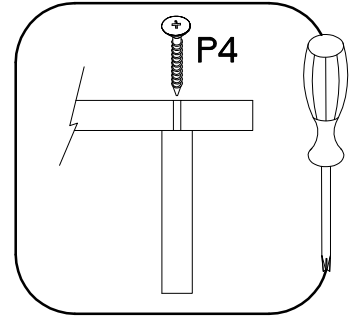



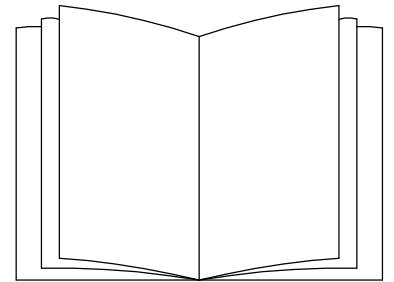
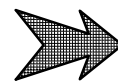
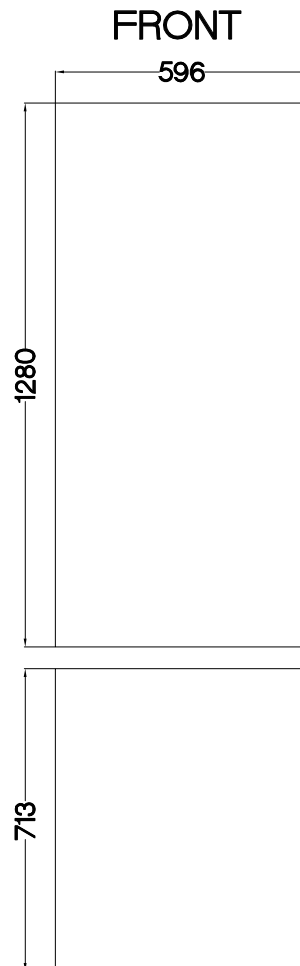
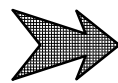
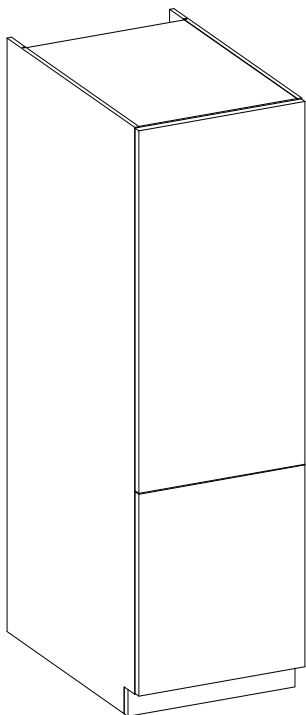

9

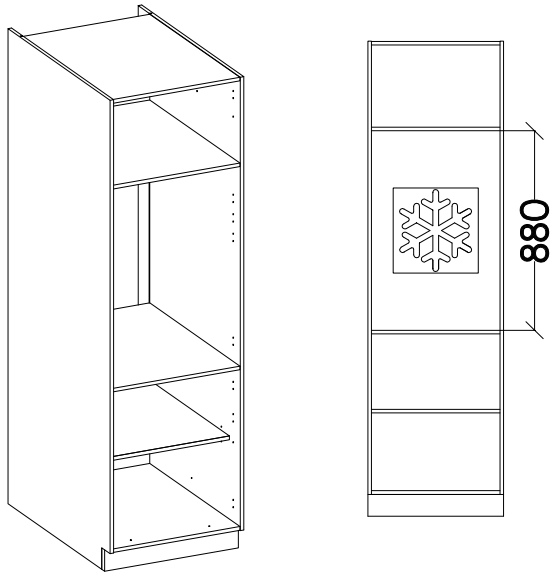

WARIANT B



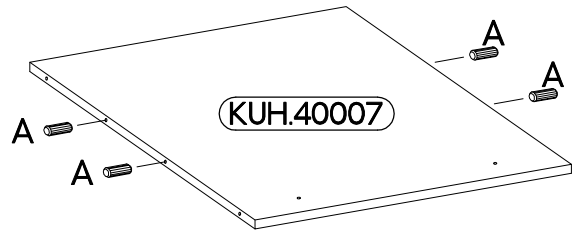
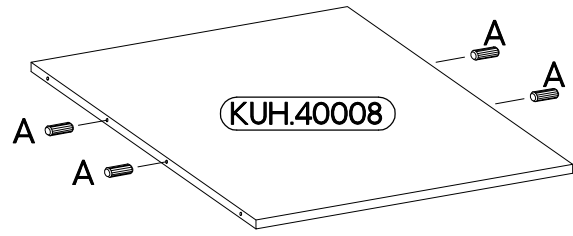
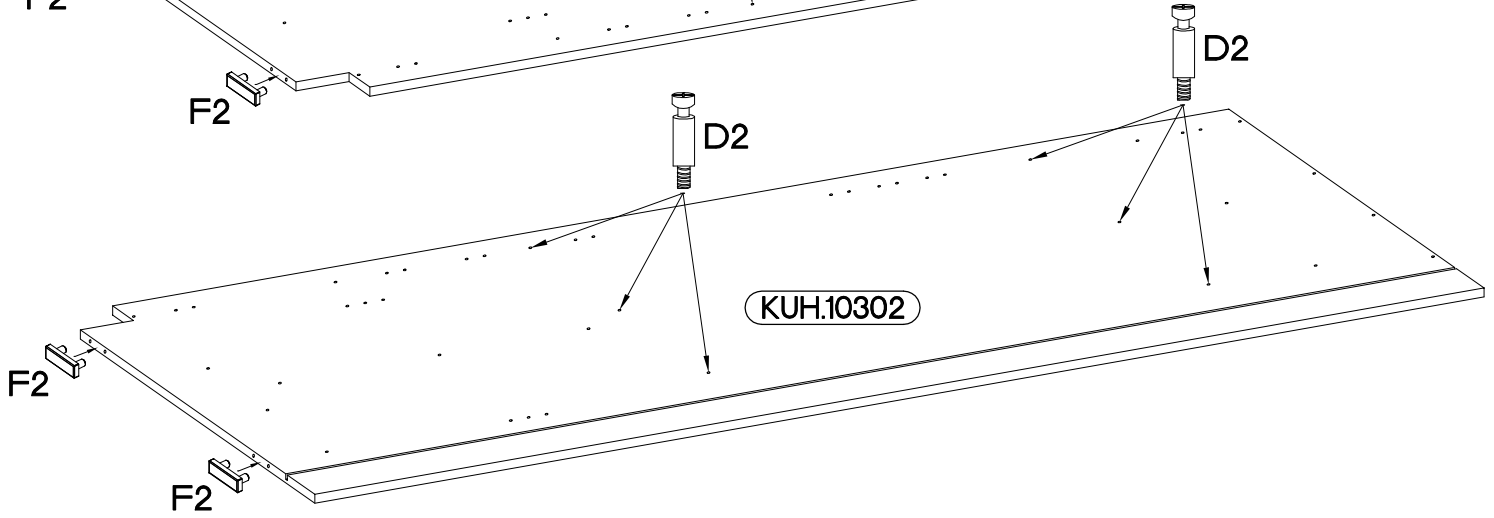
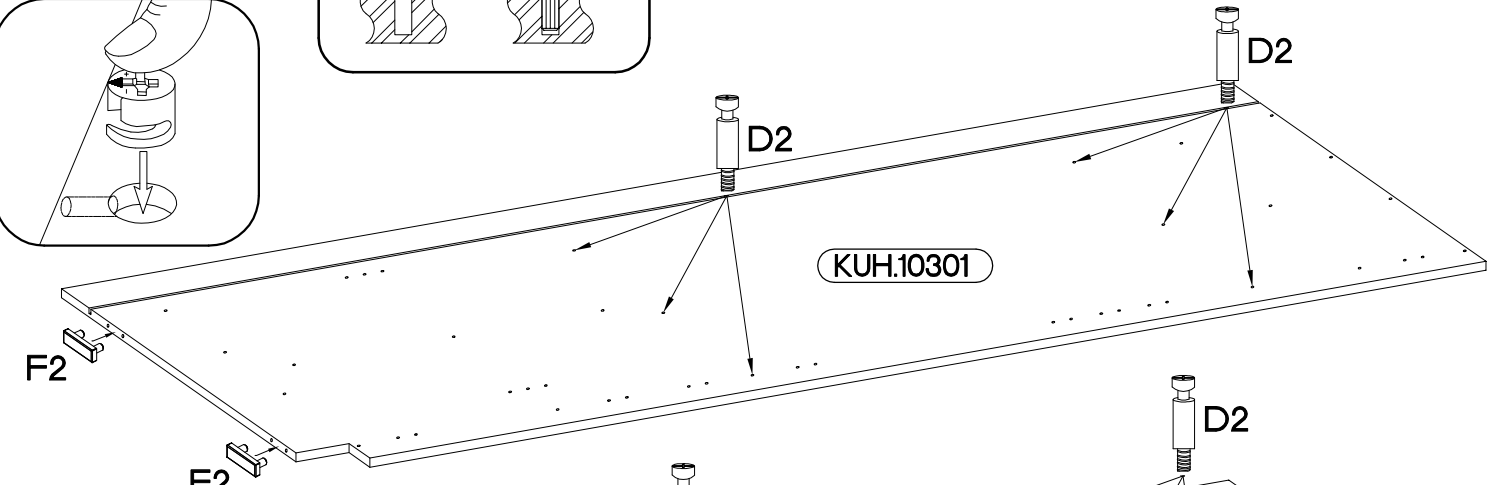
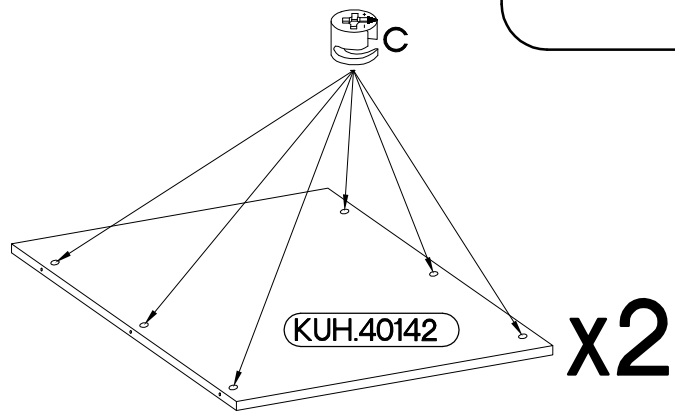
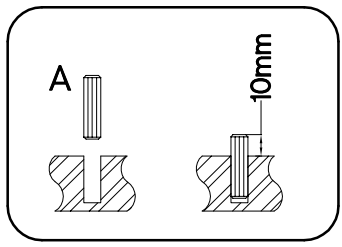
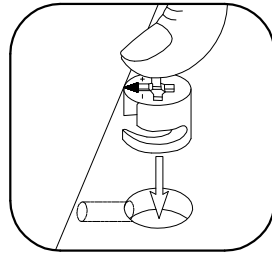
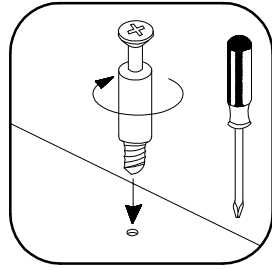
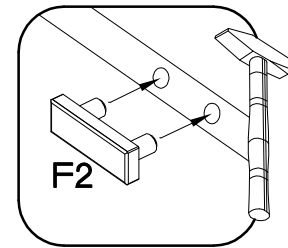
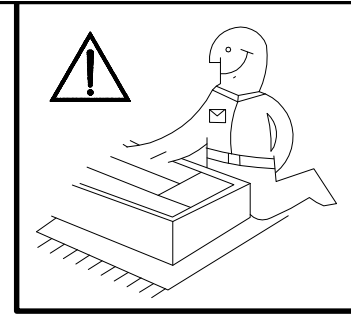

$\varnothing 8 \times 30 \text{mm}$  A	$6.5 \times 48 \times 16$  F2
8 L=20mm  D2	4 $\varnothing 15 / 12 \text{mm}$  C
12	12

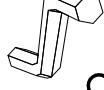

11

6,4 x 50mm

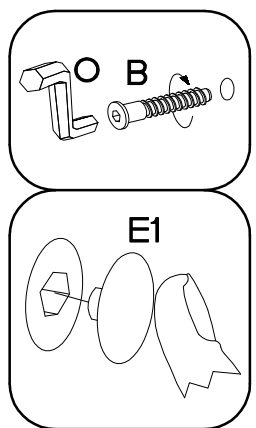
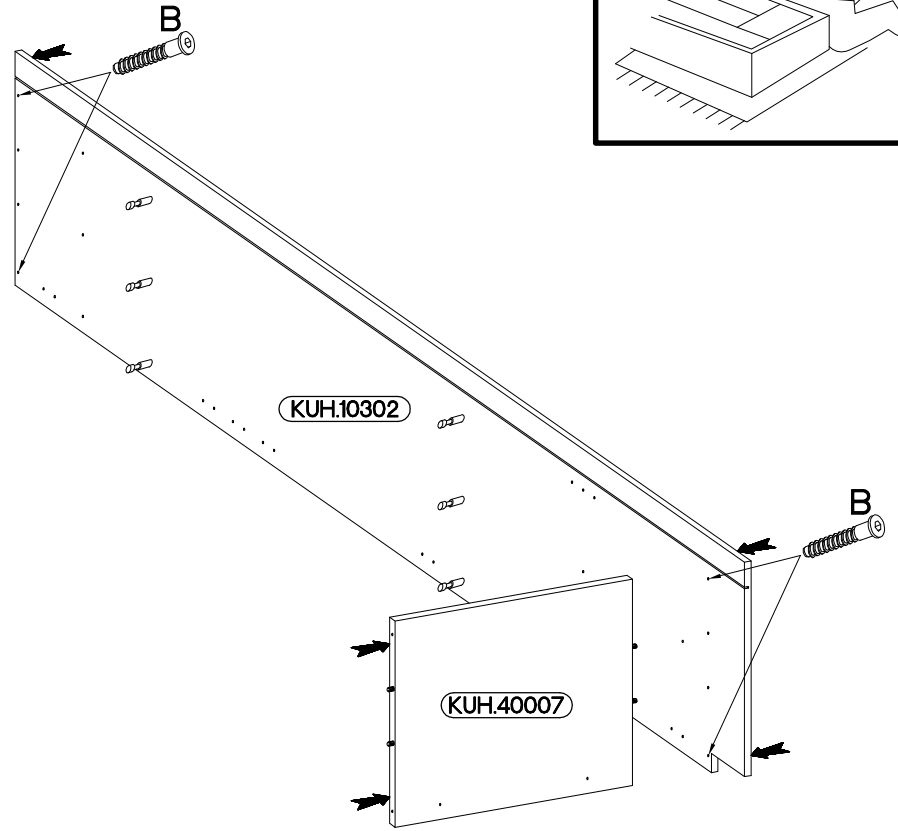
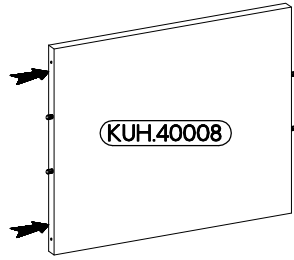
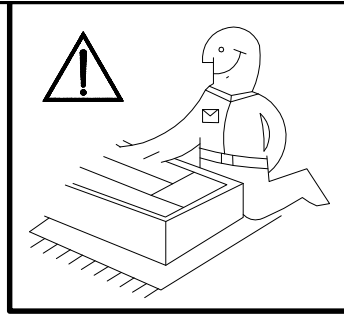

		
B	O	E1
4	1	4

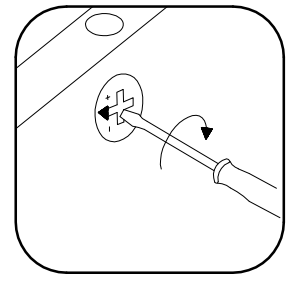
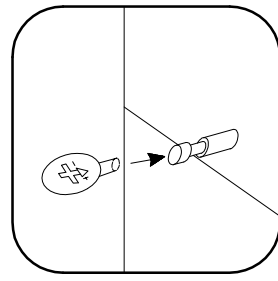
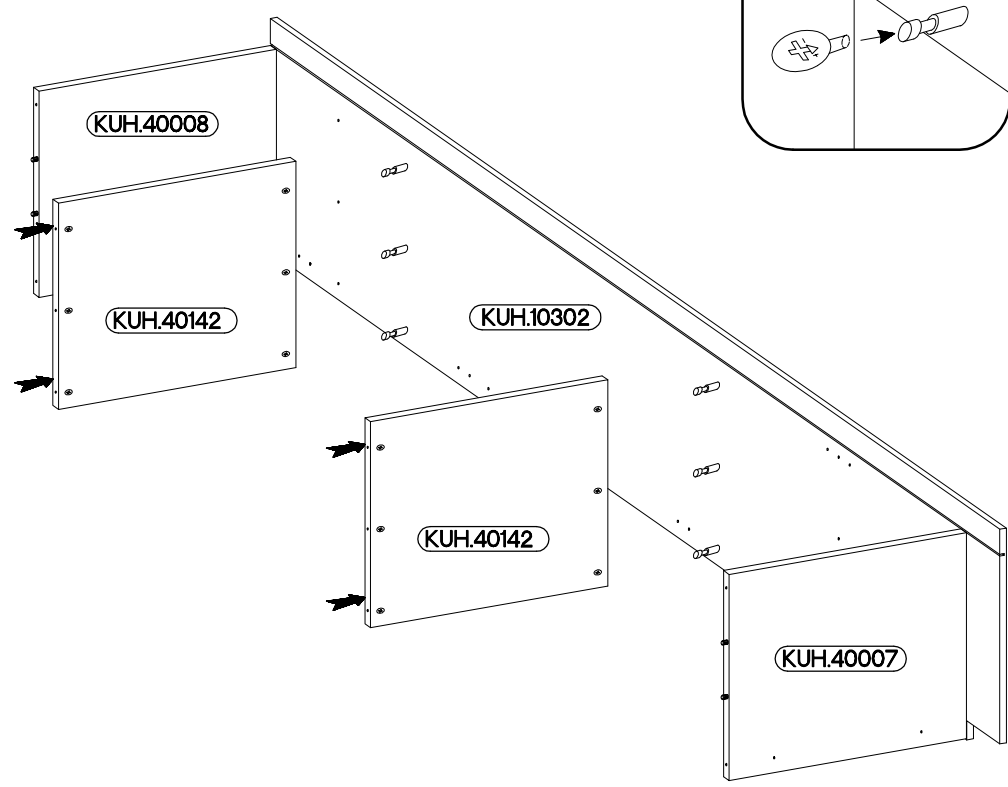

12



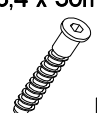
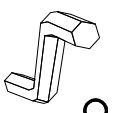

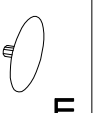
13

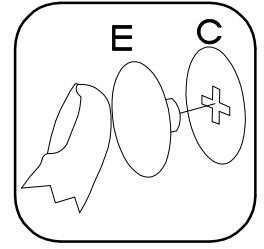
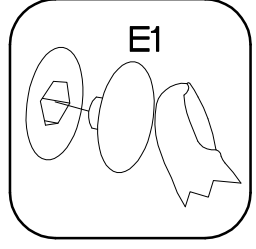
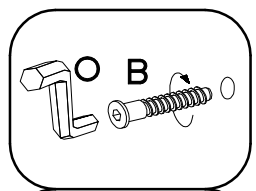
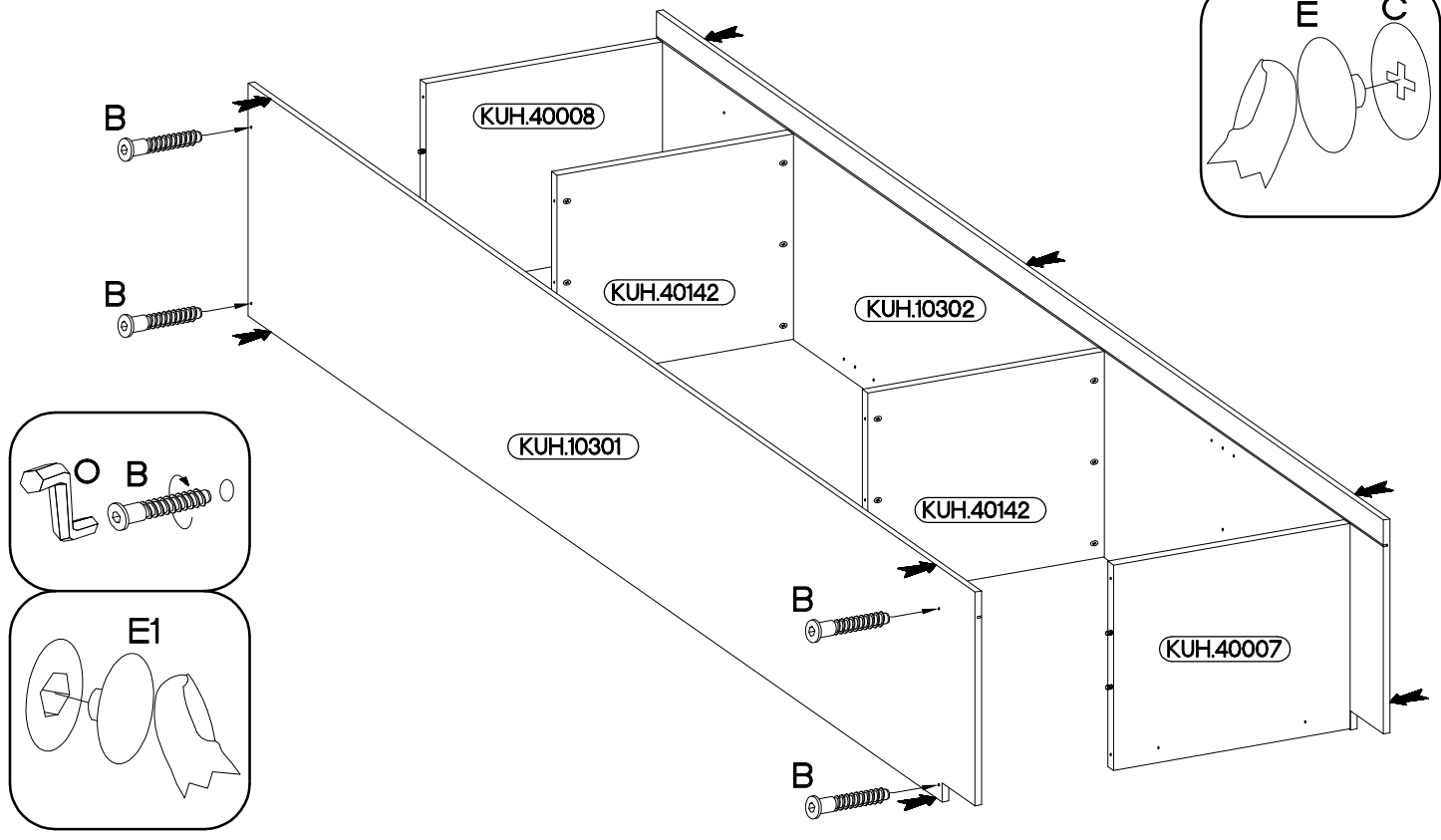
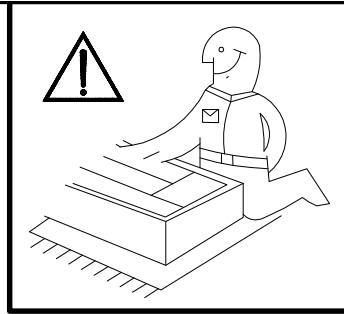
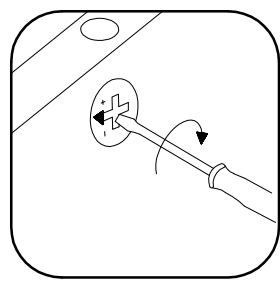
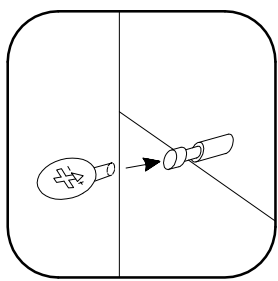
6,4 x 50mm			
			
B	O	E1	E
4	1	4	12



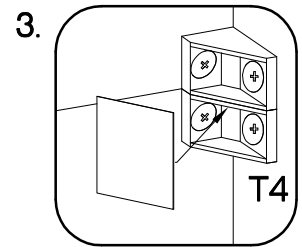
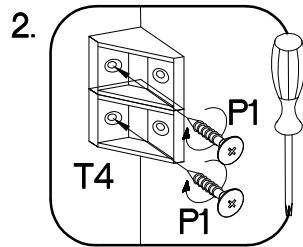
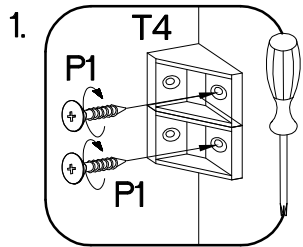
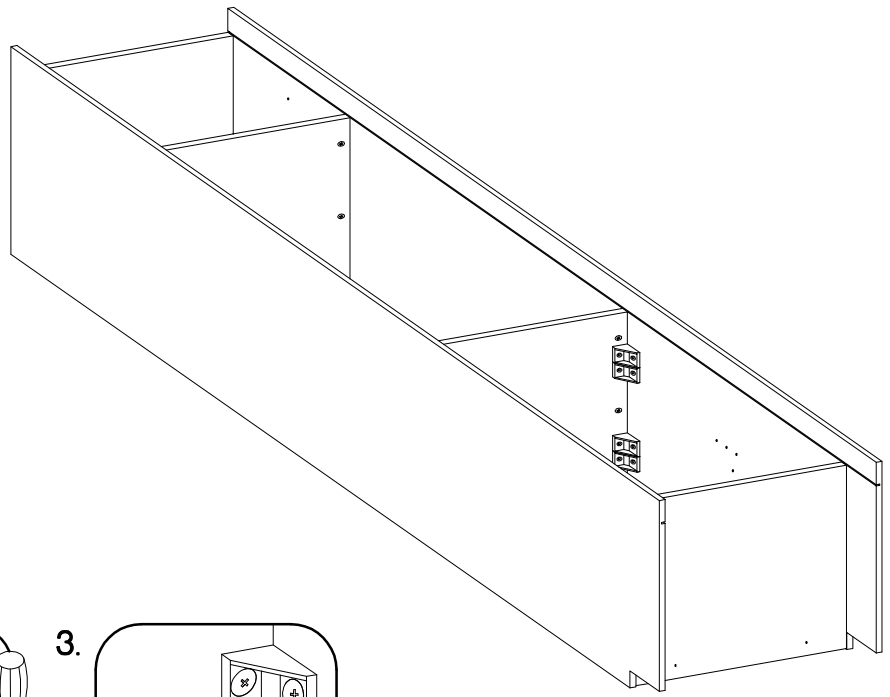
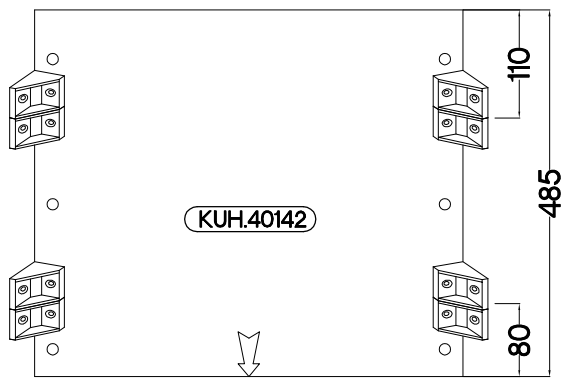

14

	
T4	P1
4	16



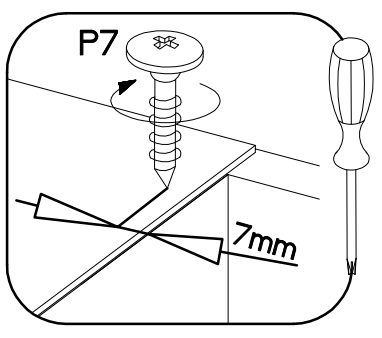
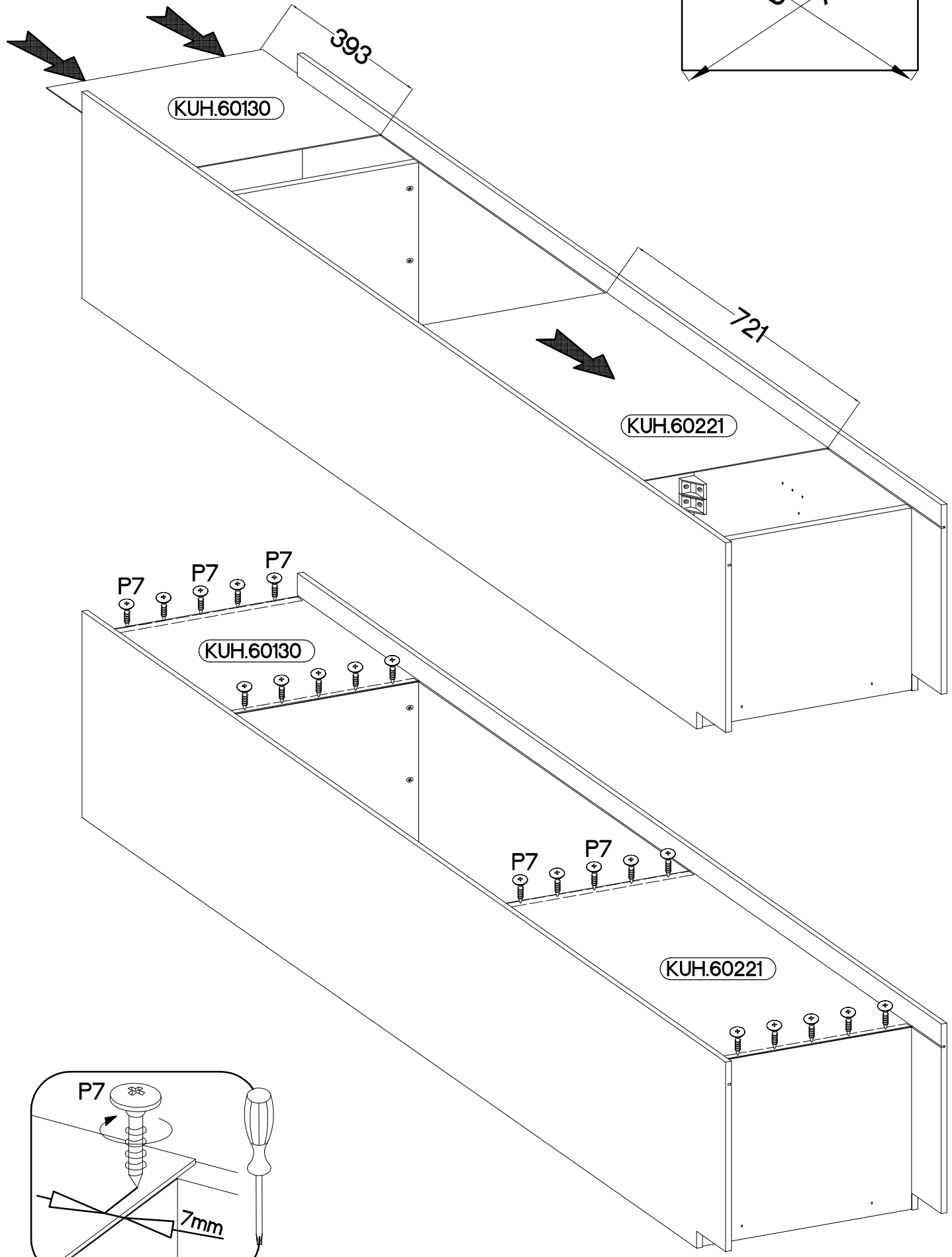
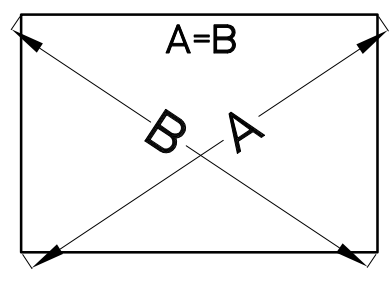

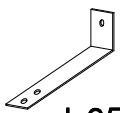
3.0x20mm
P7
15-20

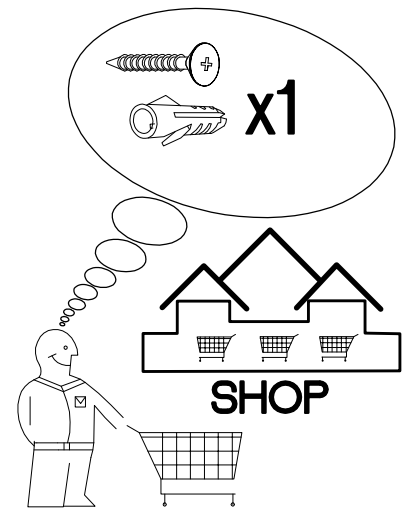
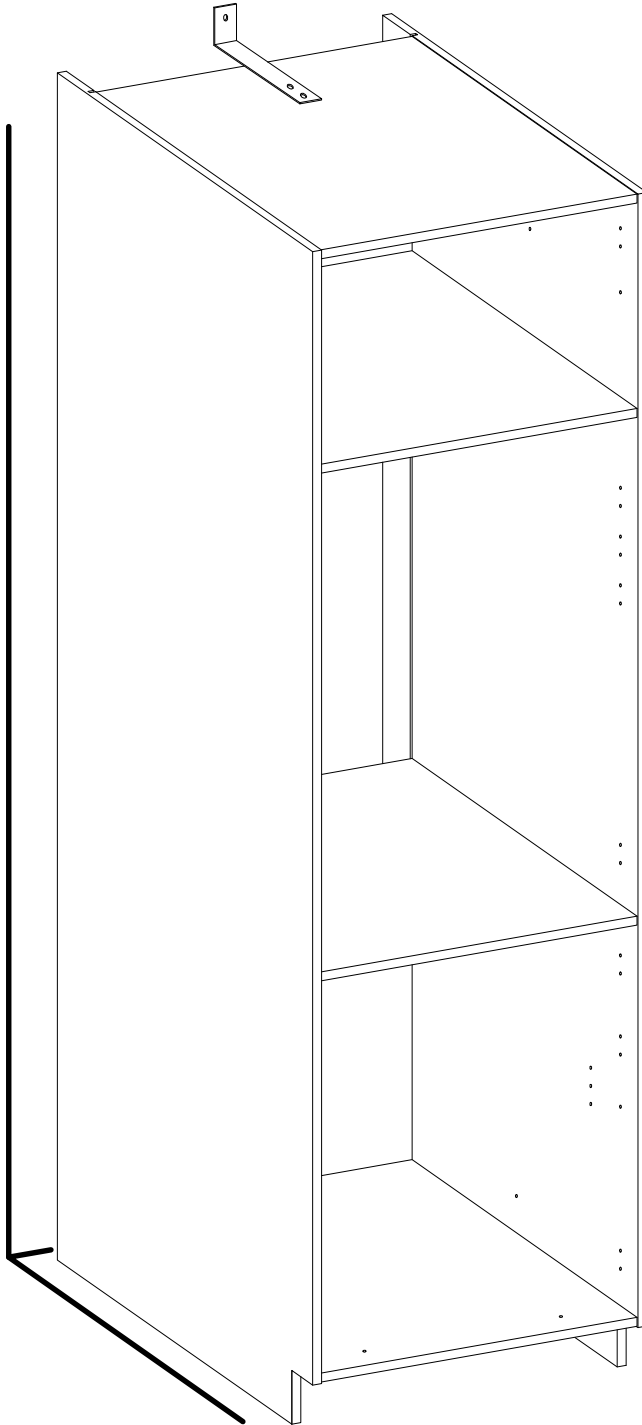
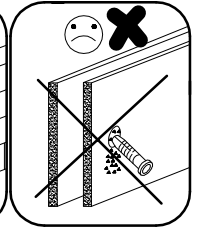
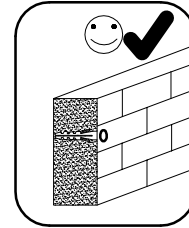
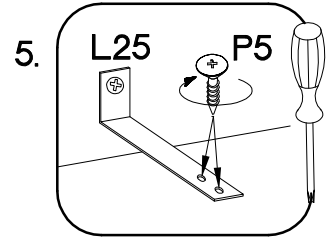
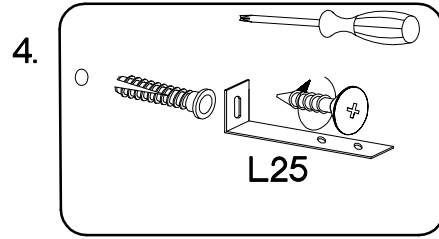
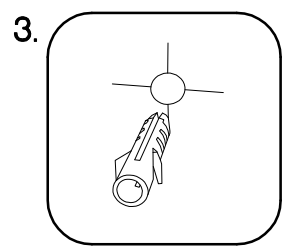
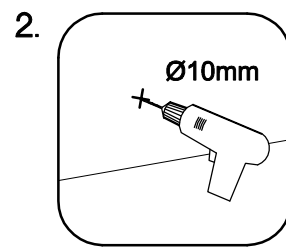
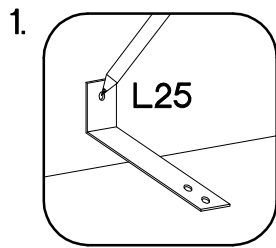

 L25 1	 +3.5x13mm P5 2
--	--



17

<p>±4.0x45mm</p>  <p>P4</p> <p>2</p>	 <p>E9</p> <p>2</p>
--	---

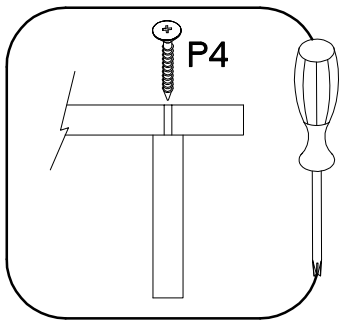
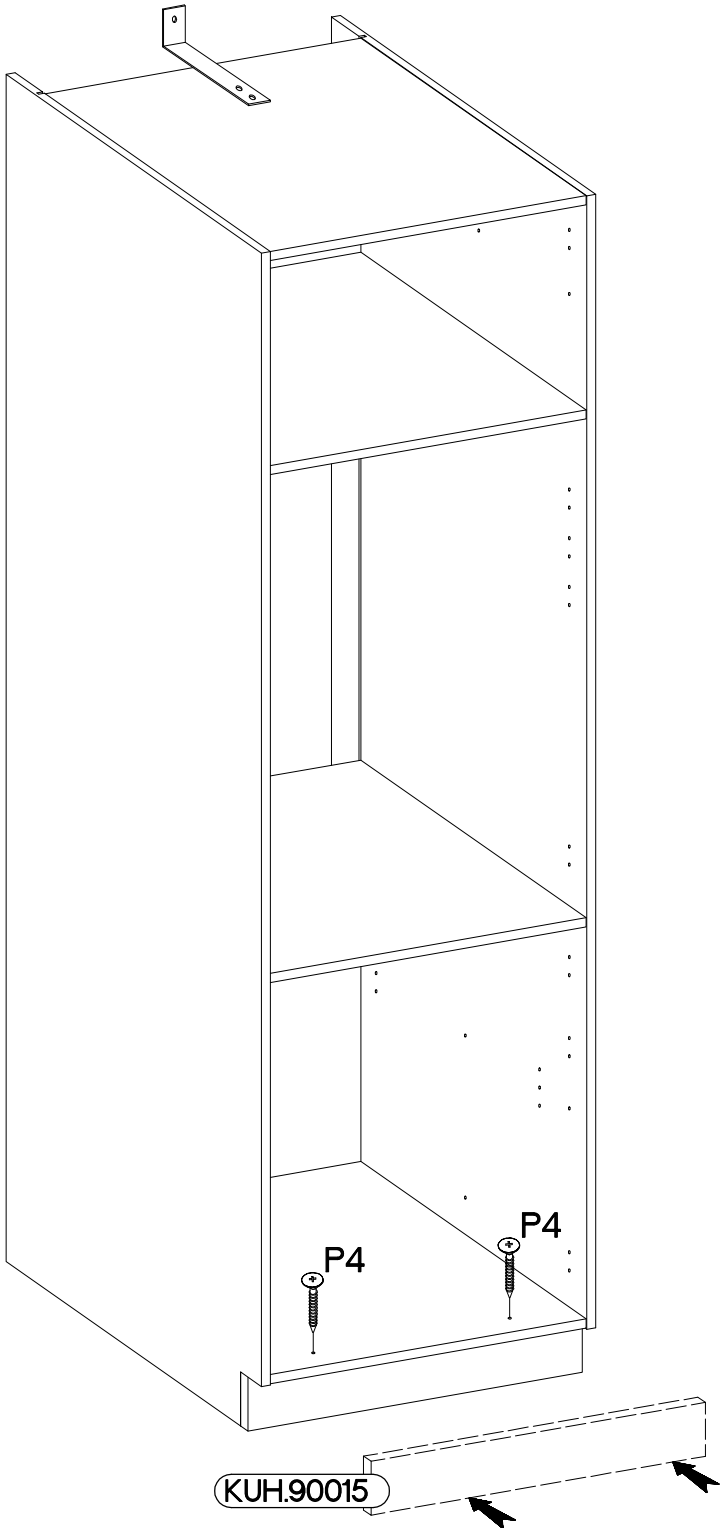

18

<p>±5/19mm</p>  <p>J</p> <p>4</p>
--

