

## 1. PŘED INSTALACÍ:

- Před instalací zkontrolujte, zda sedátko a šrouby závěsů jsou vhodné pro záchodovou mísu.
- Přečtěte si prosím pozorně tento návod, abyste zajistili bezproblémovou montáž sedátka.
- Prosím uschovejte pokyny pro budoucí použití.

## 2. ÚDRŽBA

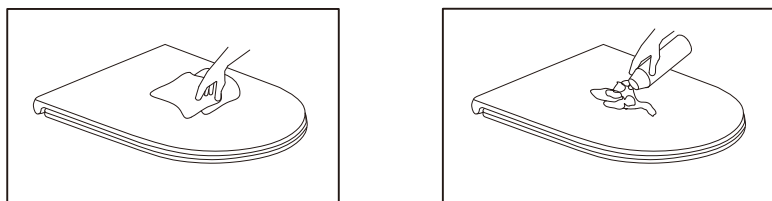

- Pravidelně čistěte sedátko vlhkým hadříkem a jemným čistícím prostředkem; Pro pohodlí lze sedák vyjmout stisknutím tlačítka a zvednutím sedátka nahoru (viz Obrázek 5 na další straně).
- S odstraněným sedákem snadno vyčistíte oblast kolem pantů.
- Zabraňte jakémukoliv rozlití kosmetiky a rozpouštědel, mohou trvale poškodit povrchovou úpravu.
- Pravidelně kontrolujte upevnění šroubů.

## 3. VAROVÁNÍ



Aby byla zachována životnost funkce zavírání, nezavírejte násilně sedadlo ani kryt.



Sedák ani poklop nečistěte silnými chemickými prostředky, abrazivními prostředky nebo tvrdými kartáči, mohlo by dojít ke zničení povrchu.



Nepokládejte těžké předměty a zabraňte pádu předmětů na sedátko.



Vyhňte se instalaci na místech se silným slunečním zářením nebo vysokou teplotou.

## 4. INSTALACE

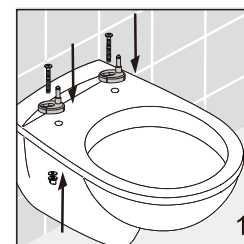
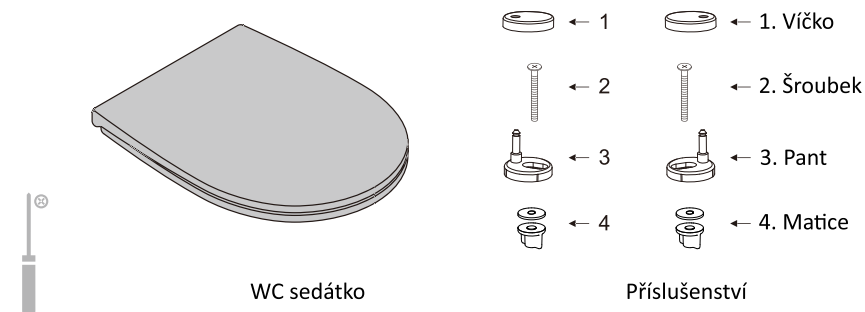

1. Přišroubujte panty  
A zespod dotáhněte matice

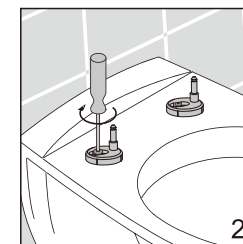

2. Napůl utáhněte šrouby

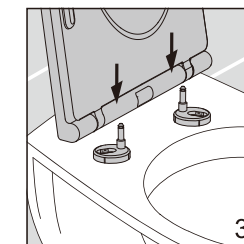

3. Srovnejte kolíky a sponu  
na sestavě sedáku

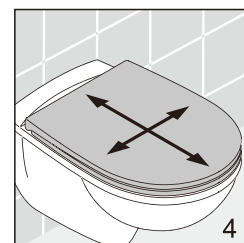

4. Sedátko vyrovnejte s WC  
mísou

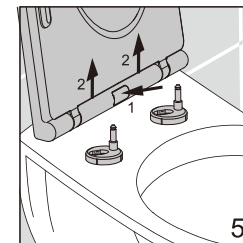

5. Stiskněte tlačítko a  
sejměte sedák a poklop

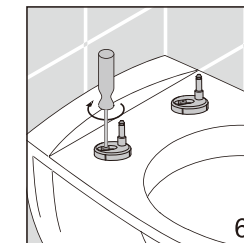

6. Utáhněte šrouby

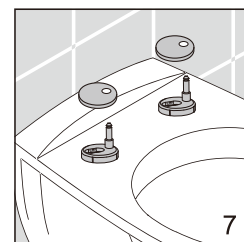

7. Nasadte krytky na  
úchyty závěsů

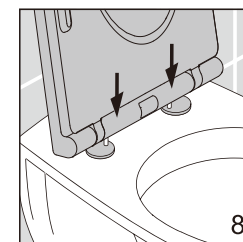

8. Připevněte záchodové  
prkénko a kryt

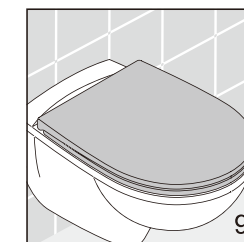

9. Hotovo

# pb TOILET SEAT INSTALATION MANUAL WITH plastbrno SOFT CLOSE AND QUICK RELEASE SYSTEM

## 1. BEFORE INSTALLATION:

- Before installation, check that the seat and the hinge bolts are a suitable fit on the toilet bowl.
- Please read these instructions carefully to ensure trouble-free fitting of the seat.
- Please retain the instructions for future reference.

## 2. MAINTENANCE:

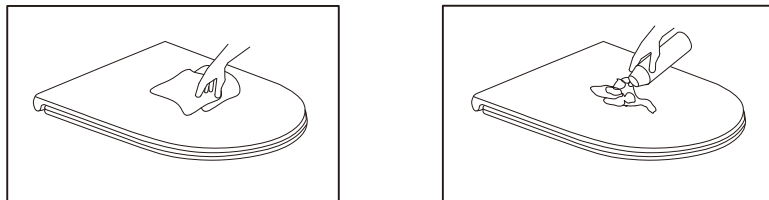

- Regularly wipe the seat using a damp cloth and mild detergent; For convenience, the seat can be removed by pressing the button and lifting the seat up (see Diagram 5 on the next page).
- With the seat removed, the area around the hinge mounts can be easily cleaned.
- Avoid spilling cosmetics and solvents as this can permanently stain the surface finish.
- Periodically check the tightness of the hinge fixing screws.

## 3. CAUTIONS:



To maintain the life span of the soft-close function, do not forcibly close the seat or cover.



Do not clean the seat or cover with strong chemical cleaners, scouring abrasives or stiff brushes as these may ruin the polished surface.



Do not place heavy objects on the cover and avoid dropping items onto the seat.



Avoid installing in locations with strong sunlight or high temperature.

## 4. INSTALLATION STEPS:

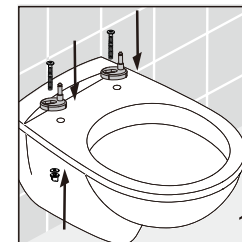
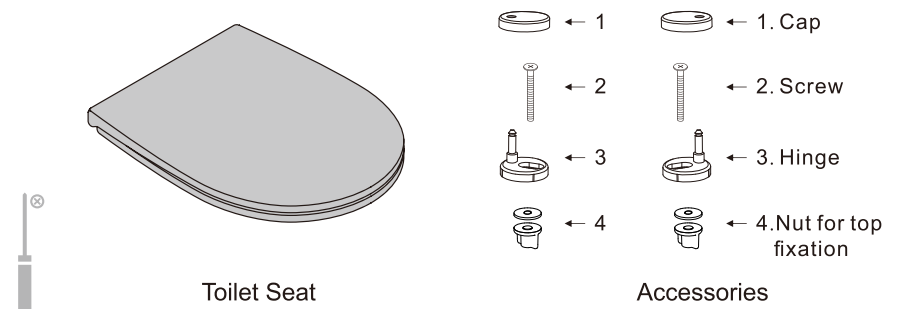

1. Insert the fixing plugs and fit the hinge fixtures

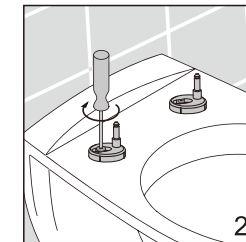

2. Half tighten the screws

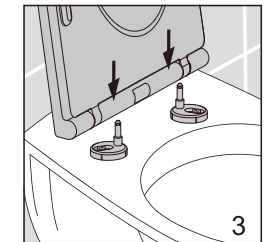

3. Align the pins and clip on the seat assembly

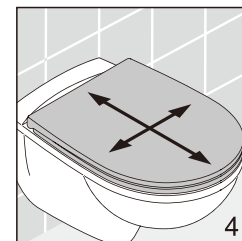

4. Align the seat with the WC bowl

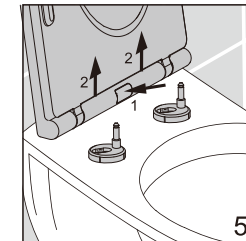

5. Press the push button and remove the seat and cover

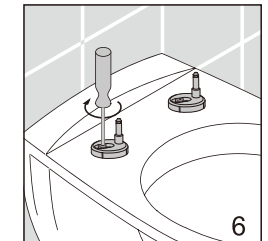

6. Tighten the screws

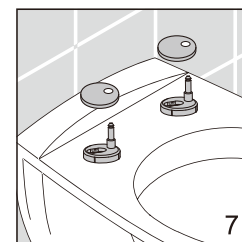

7. Fit the caps onto the hinge fixtures

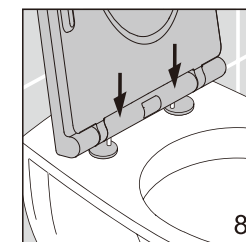

8. Clip on the toilet seat and cover

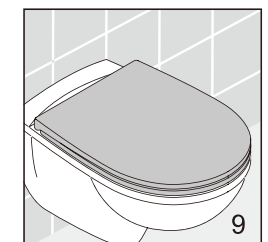

9. Finished