

COLUMBIA

This high-gloss white acrylic bath combines a very comfortable lying shape with a shower option at the foot end. Columbia features armrests and a high collar at the head end, allowing you to lie relaxed and comfortable in this bath.



Riho acrylic bathtubs are made of high-quality acrylic, fully reinforced and all through white in colour. The acrylic baths are non-aging and UV resistant. The material is completely pore-free and smooth. Lime will adhere poorly so no bacteria remain. Therefore, the baths are easy to clean. The surface is pleasantly warm. Standard the bathtub does not include a legset and overflow/drain.

Article nr.	L x W x H (cm)	Volume* (ltr)	Weight (kg)	Water height (cm)	Option Rihopool**
B004001005	140 x 70 x 47	95	18	35	Air
B002001005	150 x 75 x 47,5	110	19	37	Air / Flow
B001001005	160 x 75 x 43,5	100	18	33	Air / Flow
B003001005	175 x 80 x 48,5	175	23	37	Air / Flow

* The contents of the baths are measured including the (average) volume of one person.

** Rihopool whirlpoolsystems already include a legset.

AIR

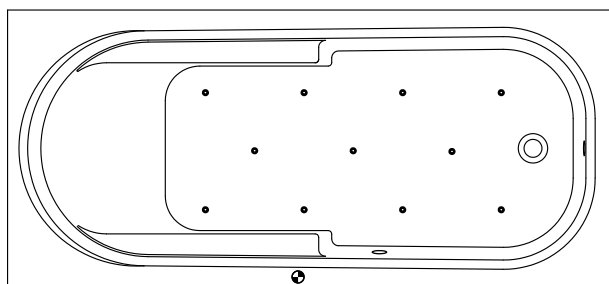

11 aerojets

FLOW

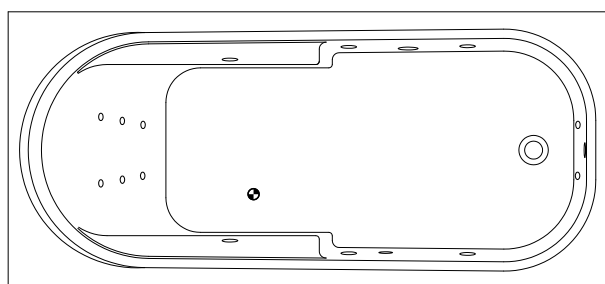

6+6+2 hydrojets

Additional to purchase

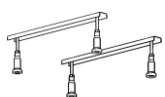

Legset 01U
207093

Whirlpools already include a legset!



Mc Alpine
208867



Riho black
208711



Viega Multiplex
208873



Viega Multiplex Trio
208875

Optional to purchase



Headrest 19
207043



Headrest 19
207044



Headrest
207023

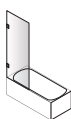

See next page

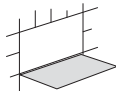

Inspection hatch
207019

Data is subject to changes and/or errors

Right type

Left type

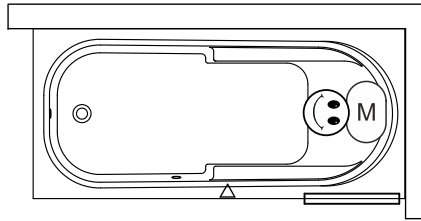
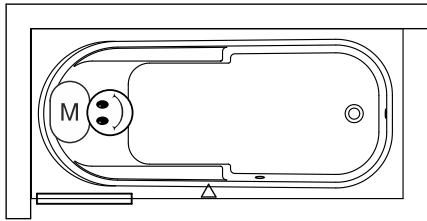

Motor Hydro or Aero



Control panel



Service hatch

Bath screen

Scandic X107 | Scandic X108* | Scandic X109* | Scandic 109V | Scandic X409 | Novik Z107* | Grid GB501* | Lucid GD501* | Novik Z500* | Scandic X500*

* The bathscreen can't open inwards because of a rising edge on the head side of the tub.

BATH	Front panel	Side panel	Height (cm)
B004001005	209294	209279	57
B002001005	209296	209280	57
B001001005	209298	209280	57
B003001005	209303	209281	57

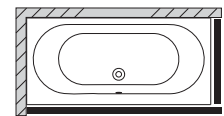
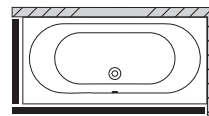
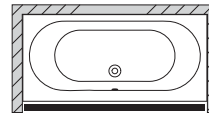

	A	B	C	D	E	F	G	H
B004001005	140	70	47	124	100	43	51	57
B002001005	150	75	47,5	133	100	44	52,5	58,5
B001001005	160	75	43,5	138	111	44,5	52,5	58,5
B003001005	175	80	48,5	158	123	45	56	64

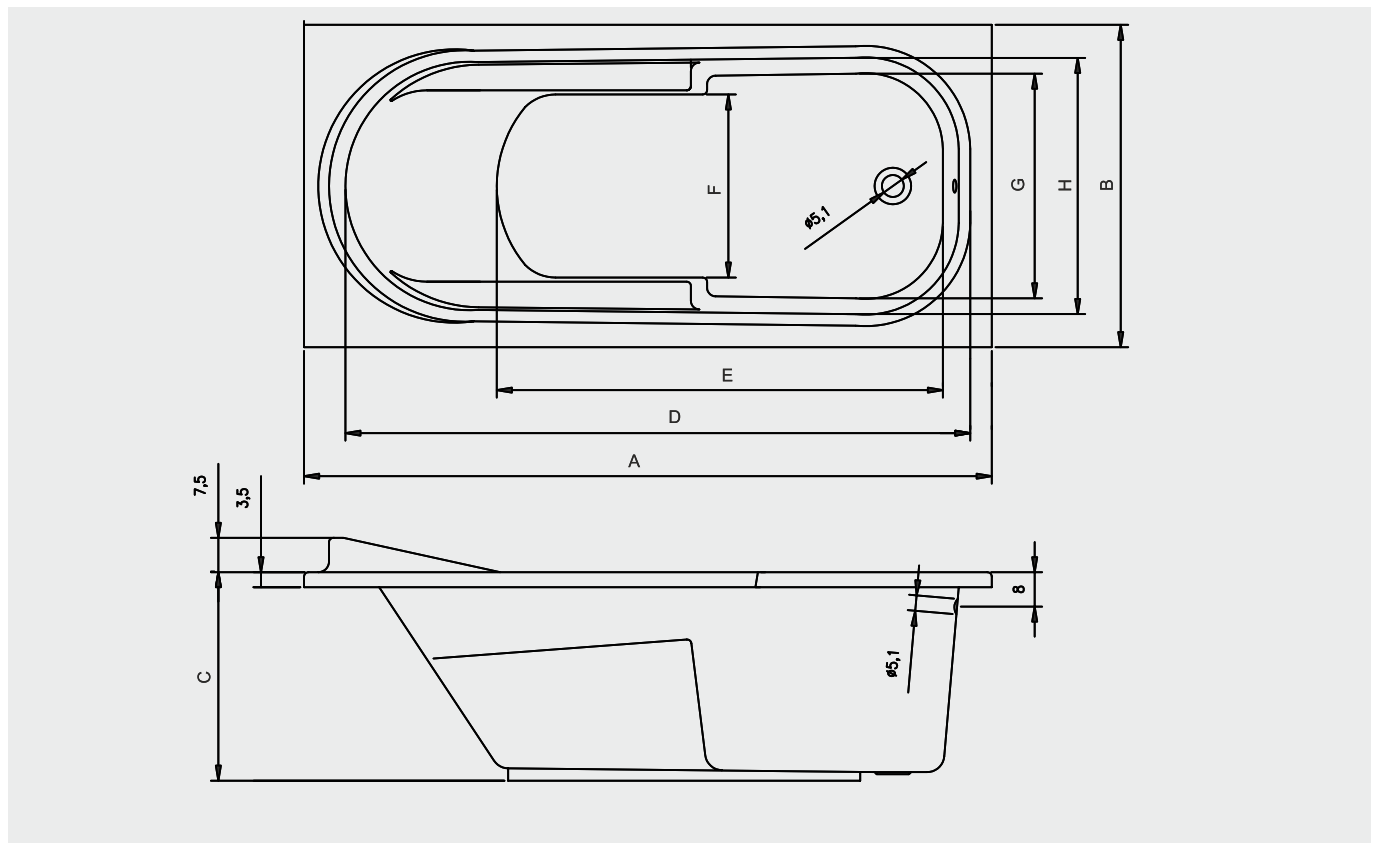

Data is subject to changes and/or errors