

# Montageanleitung

**CN** 安装说明

**CRO** Upute za ugradnju

**CZ** Návod k instalaci

**DK** Montagevejledning

**E** Instrucciones de montaje

**F** Instructions de montage

**GB** Installation instructions

**GR** Οδηγία συναρμολόγησης

**H** Szerelési utasítás

**I** Istruzioni di montaggio

**NL** Montagehandleiding

**NO** Installasjonsanvisning

**P** Instrução de montagem

**PL** Instrukcja montażu

**ROM** Instrucțiuni de montare

**RU** Указания по установке

**S** Monteringsanvisning

**SER** Uputstvo za montažu

**SF** Asennusohje

**SK** Návod na montáž

**SLO** Navodila za montažo

**TR** Montaj talimatı

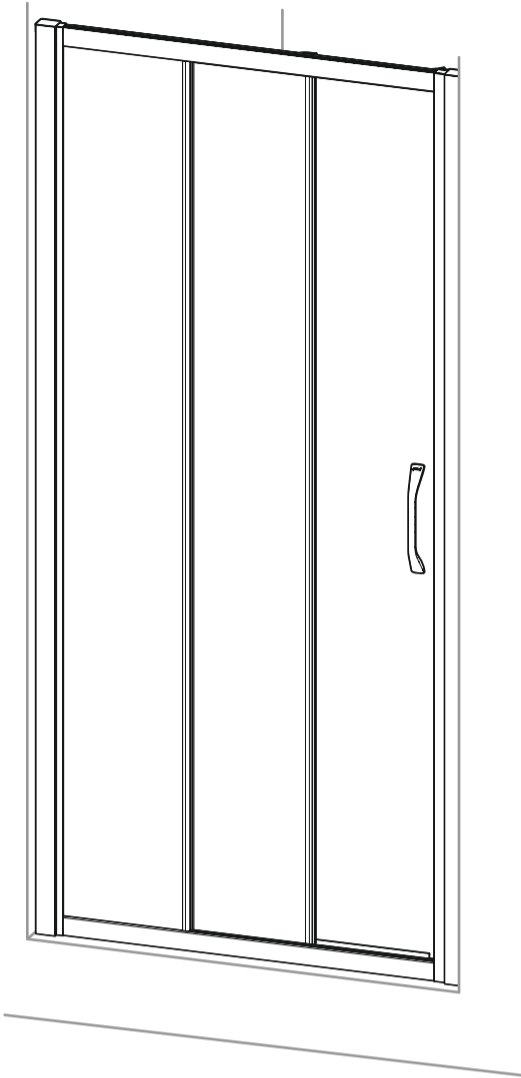

## 🇩🇪 Wichtiger Hinweis:

Bitte prüfen Sie die Duschabtrennung vor dem Einbau auf Transportschäden und Vollständigkeit. Nach dem Einbau können Beanstandungen nicht mehr anerkannt werden. Bitte prüfen Sie auf dem Karton, ob das Maß WEM oder M ist.

## 🇨🇳 重要提示:

请在安装淋浴隔板之前检查是否存在运输损坏以及货物是否完整。安装之后才提交的投诉不予受理。请检查纸箱上的尺寸是WEM还是M。

## 🇸🇰 Važna napomena:

Provjerite potpunost pregrada za tuševe i moguća oštećenja pri transportu prije ugradnje. Nakon ugradnje ne možemo više priznati reklamacije. Provjerite na kartonu je li veličina WEM ili M.

## 🇨🇿 Důležité upozornění:

Před instalací sprchové kabiny přezkontrolujte, prosím, zda nebyla kabina během přepravy poškozena a zda je dodávka kompletní. Po zabudování nemůže být reklamacie již uznána. Zkontrolujte, jestli na krabici, jestli je rozměr WEM nebo M.

## 🇳🇴 Viktig oplysning:

Inden kabinevæggen monteres, undersøges den for transportskader o.lign., idet reklamationer ikke kan godkendes efter at montering har fundet sted. Se efter på papkassen, om målet er WEM eller M.

## 🇪🇸 Nota importante:

Por favor, antes de montar la mampara se debe controlar que el producto no haya sufrido daños durante el transporte y que todas las piezas estén completas. Una vez instalado el artículo no asumiremos ninguna responsabilidad por las eventuales reclamaciones. Por favor compruebe en el cartón si se trata de la medida WEM o bien M.

## 🇫🇷 Remarque importante:

avant de procéder au montage, vérifiez que le pare-douche est complet et qu'il n'a pas été endommagé lors du transport. Aucune réclamation ne pourra être admise après le montage. Vérifier si la mesure indiquée sur le carton est WEM ou M.

## 🇬🇧 Important information:

Please check the shower enclosure for transport damage and completeness before installation. Complaints made following installation cannot be accepted. Please check the information on the cardboard box whether the dimensions are WEM or M.

## 🇮🇹 Σημαντική υπόδειξη:

Παρακαλώ ελέγξτε το διαχωριστικό ντουζιέρας πριν από την τοποθέτηση για ζημιές μεταφοράς και πληρότητα. Μετά την τοποθέτηση δεν μπορεί πια να αναγνωριστούν παράπονα σχετικά με τα παραπάνω. Παρακαλώ ελέγξτε στη συσκευασία εάν η διάσταση είναι WEM ή M.

## 🇭🇺 Fontos tudnivaló:

Kérjük, beépítés előtt ellenőrizze a zuhanylevélasztót, hogy a szállításnál nem sérült-e és hogy hiánytalan-e. A beépítés után már nem fogadunk el reklamációt. Kérjük ellenőrizze a kartonon, hogy a méret WEM, vagy M.

## 🇮🇹 Avviso importante:

Prima di effettuare il montaggio vi preghiamo di controllare se la parete divisoria della doccia presenta dei danni di trasporto. Dopo il montaggio non vengono più accettati reclami. Controllare sul cartone se la misura corrisponde a WEM o M.

## 🇳🇱 Belangrijk:

Controleer voor het inbouwen of het douchescherm bij het transport beschadigd is en of het volledig is. Na het inbouwen kunnen klachten niet meer in behandeling genomen worden. Kijk op de doos of de maat WEM of M is.

## 🇳🇴 Viktig informasjon:

Vennligst sjekk dusjkabinettet for transportskader og at det er komplett før installasjon. Klager som gjøres etter installasjon kan ikke aksepteres. Kontroller om målene på kartongen er WEM eller M.

## 🇵🇹 Indicação importante:

Favor verificar antes da instalação se a separação de chuveiro está completa e se sofreu danos de transporte. Depois da montagem não se aceiteam reclamações. Por favor, verifique se a medida indicada na embalagem é WEM ou M.

## 🇵🇱 Ważna wskazówka:

Przed zabudowaniem przysznycowej ścianki działowej należy sprawdzić jej kompletność i skontrolować na obecność ewentualnych uszkodzeń powstałych w czasie transportu. Po dokonaniu zabudowy reklamacje nie będą uwzględniane. Sprawdź na kartonie, czy wymiarem to WEM lub M.

## 🇷🇴 Instrucțiune importantă:

Înainte de montare vă rugăm să inspecțiați cabina de duș cu privire la integritate și la eventualele deteriorări produse în urma transportului. După montare nu se mai admit reclamații. Vă rugăm să verificați mărimea înscrisă pe ambalaj, dacă este WEM sau M.

## 🇷🇺 Важная информация:

Перед сборкой проверьте душевую кабину на наличие повреждений и ее укомплектованность. Претензии после сборки не принимаются. Уточните на картонной коробке, какой это размер — WEM или M.

## 🇸🇪 Viktig hänvisning:

Innan duschskiljeväggen byggs in måste man kontrollera att inga transportskador uppkommit på den och att den är fullständig. När den byggs in kan inte några reklamationer accepteras längre. Kontrollera på kartongen om måttet är WEM eller M.

## 🇸🇰 Važna napomena:

Molimo vas da proverite da li je tuš kabina oštećena u transportu i da li je potpuna. Reklamacije se po obavljenoj montaži više ne priznaju. Proverite da li se na kartonu nalazi oznaka WEM ili M.

## 🇸🇫 Tärkeä ohje:

Tarkista suihkuseinäke ennen asennusta kuljetusvauroiden varalta ja tarkista myös toimituksen sisältö. Asennuksen jälkeen ei valituksia enää voida ottaa huomioon. Tarkista laatikosta, onko mitta WEM tai M.

## 🇸🇯 Dôležité upozornenie:

Pred abudovaním oddelovacej sprchovacej steny skontrolujte prosím, i nebola pokodená počas prepravy a i je dodávka úplná. Po zabudovaní sa reklamácie u neuznávajú. Prosím skontrolujte na kartóne, či je to rozmer WEM alebo M.

## 🇸🇯 Važen nasvet:

Pred montažo preverite, e je bila kabina za prhanje na prevozu poškodovana in da je popolna. Reklamacije po konani montaži ne moremo ve upoštevati. Prosimo preverite na kartonu, ali gre za mero WEM ali M.

## 🇮🇹 Önemli açıklama:

Du duvarını takmadan önce lütfen nakliyat hasarı ve eksiksiz olup olmadığını kontrol ediniz. Du duvarını takdıktan sonra yapılacak ikayetler kabul edilmez. Lütfen kartonun üzerindeki ölçününü WEM mi, M mi olduğunu kontrol ediniz.

## 🇩🇪 Sicherheitshinweis:

Die Installation ist durch einen Fachmann durchzuführen.

Hüppe Einscheibensicherheitsgläser dürfen nachträglich nicht bearbeitet werden. Stets die Kanten der Scheiben schützen, z. B. beim Abstellen der Scheiben immer Holz oder Pappe als Unterlage benutzen.

## 🇨🇳 安全提示:

安装工作应由一名专业人员进行。HÜPPE单层安全玻璃不可事后再进行处理。请始终保护玻璃边缘，比如在放下玻璃时始终使用木头或纸板垫底。

## 🇸🇰 Sigurnosna napomena:

Ugradnju treba obaviti stručnjak. Ne smijete naknadno obrađivati jednoslojna sigurnosna stakla Hüppe. Uvijek zaštitite rubove ploča, npr. pri spuštanju ploča uvijek upotrijebite drvo ili karton kao podlogu.

## 🇨🇿 Bezpečnostní pokyny:

Instalaci smí provést pouze odborník. Jednoduché bezpečnostní okenní tabule firmy Hüppe nesmí být dodatečně opracovávány. Hrany tabulí musí být neustále chráněny; používejte např. při stavění tabulí na hrany vždy dřevěnou nebo lepenkovou podložku.

## 🇳🇴 Sikkerhetsoplysning:

Installationen skal foretages af en fagmand, der råder over den fornødne ekspertise. Der må ikke foretages ændringer af Hüppe-sikkerhedsglas (enkeltruede). Sørg for at beskytte rudens kanter og brug træ eller karton som underlag, når De stiller den fra Dem.

## 🇪🇸 Reglamento de seguridad:

Es imprescindible que se efectúe la instalación debidamente por parte de un técnico especializado. Una vez instalados los vidrios de seguridad de Hüppe no se deben someter a manipulación posterior. Hay que observar siempre la protección de los cantos de los vidrios, al apoyar los vidrios en el suelo depositarlos p. e. sobre madera o cartón.

## 🇫🇷 Remarques concernant la sécurité:

l'installation doit être confiée à un professionnel. Vous ne devez en aucune façon tenter de retailer les vitrages Hüppe en verre sécurit. Veillez à en protéger les bords, par exemple en utilisant du bois ou du carton comme support avant de les poser par terre.

## 🇬🇧 Safety information

Installation must be carried out by trained personnel. Single-pane, safety glass panels from Hüppe must not be reworked in any way following supply. Always protect the edges of the panes, e.g. always set down on a strip of wood or card.

## 🇮🇹 Υπόδειξη ασφαλείας:

Η εγκατάσταση πρέπει να διενεργηθεί από ειδικό. Τα μονά τζάμια ασφαλείας της Hüppe δεν επιτρέπεται να επεξεργαστούν εκ των υστέρων. Να προστατεύετε πάντα τις ακμές των τζαμιών, π. χ. κατά την αποθήκευσή τους να χρησιμοποιείτε πάντα ξύλο ή χαρτόνι ως υπόθεμα.

## 🇭🇺 Biztonsági tudnivalók:

A beszerelést szakemberrel végeztesse! A Hüppe-féle egy rétegű biztonsági üvegből készült ajtókat nem szabad utólag megmunkálni. Az üvegek széleit mindig védje, pl. az üveg leállításánál mindig használjon alátétként fát vagy papírelemet.

## 🇮🇹 Cenno sulla sicurezza:

Il montaggio deve venire effettuato da un tecnico specializzato. Non è lecito eseguire lavorazioni successive sui vetri di sicurezza Hüppe a lastra singola. Proteggete sempre gli orli delle lastre, p. es. impiegate sempre del legno o della carta come appoggio per le lastre che vengono messe da parte.

## 🇳🇱 Veiligheidsvoorschrift:

De installatie moet door een vakman worden uitgevoerd. Hüppe gehard veiligheidsglas mag niet achteraf worden bewerkt. Bescherm altijd de zijkanten van de ruit; gebruik bv. bij het plaatsen van de ruit altijd hout of karton als ondergrond.

## 🇳🇴 Sikkerhetsinformasjon:

Installasjon må gjøres av opplært personell. Helpeplate sikkerhetsglass paneler fra Hüppe må ikke endres på noen måte etter levering. Beskytt alltid kantene av glasset, sett det f.eks. ned på et stykke tre eller papp.

## 🇵🇹 Indicação de segurança:

A instalação deve ser feita por um especialista. Os vidros de segurança de Hüppe não devem ser trabalhados ulteriormente. Proteger sempre os cantos dos vidros utilizando p.expl. madeira ou cartão como base para depositar o vidro.

## 🇵🇱 Wskazówki bezpieczeństwa:

Instalację należy powierzyć fachowcowi. Jednowarstwowych szyb bezpiecznych firmy Hüppe nie należy poddawać dalszej obróbce. Przy odstawianiu szyb chronić krawędzie, np. przez ustawienie na drewnianej lub tekturowej podkładce.

## 🇷🇴 Instrucțiune de siguranță:

Instalarea trebuie efectuată de un specialist. Nu este permisă o prelucrare ulterioară a panourilor din geam securizat Hüppe. Protejați întotdeauna muchiile geamurilor, de exemplu: la depunerea geamurilor pe podul utilizați întotdeauna suporturi din lemn sau carton.

## 🇷🇺 Информация по безопасности:

Сборку должен производить подготовленный персонал. После поставки одиночные панели и панели из безопасного стекла фирмы Hüppe нельзя каким-либо образом переделывать. Обеспечивайте постоянную защиту кромок панелей, напр., всегда устанавливайте их на брус или картон.

## 🇸🇪 Säkerhetsupplysning:

Installationen ska genomföras av en fackman. Hüppe säkerhetsglas med ett glas får inte bearbetas ytterligare efteråt. Man måste alltid se till att skydda glasens kanter, t ex alltid använda trä eller papp som underlag när man ställer ifrån sig glasen.

## 🇸🇰 Mere opreza:

Instaliranje treba da obavi stručnjak. Jednostrana sigurnosna stakla Hüppe ne smeju se naknadno obrađivati. Uvek štitiite rubove stakala, na primer prilikom odlaganja uvek postavite komad drveta ili kartona kao podlogu.

## 🇸🇯 Turvallisuusohje:

Asennus on suoritettava ammattihenkilön toimesta. Yksilasisia Hüppe-varmuuslaseja ei saa käsitellä jälkikäteen. Suojaa aina lasien reunat; esim. maahan laskettaessa käytä aina puu- tai pahvialustaa.

## 🇸🇯 Bezpečnostné pokyny:

Instaláciu musí previes odborník. Bezpenostné jednovrstvové sklá Hüppe sa dodatočne nesmú upravovať. Hrany tabú musia byť stále chránené, napr. pred odstaviením tabú používajte zakadým drevenú alebo lepenkovú podložku.

## 🇸🇯 Vamostni nasveti:

Montažo mora opraviti strokovnjak. Vamostne enostenske šipe proizvajalca Hüppe ne smete naknadno obdelovati. Vedno morate zaštititi robove in šipe, npr. e odstavite šipe vzemite vedno les ali karton za podlogo.

## 🇮🇹 Emniet açıklaması:

Du duvarının bir usta tarafından takılması gereklidir. Hüppe'nin emniyet camından mamül tek katlı levhalarının sonradan ilenmesi yasaktır. Camın kenarlarını, örnein camı yere koyarken altına tahta veya karton koyarak daima koruyunuz.

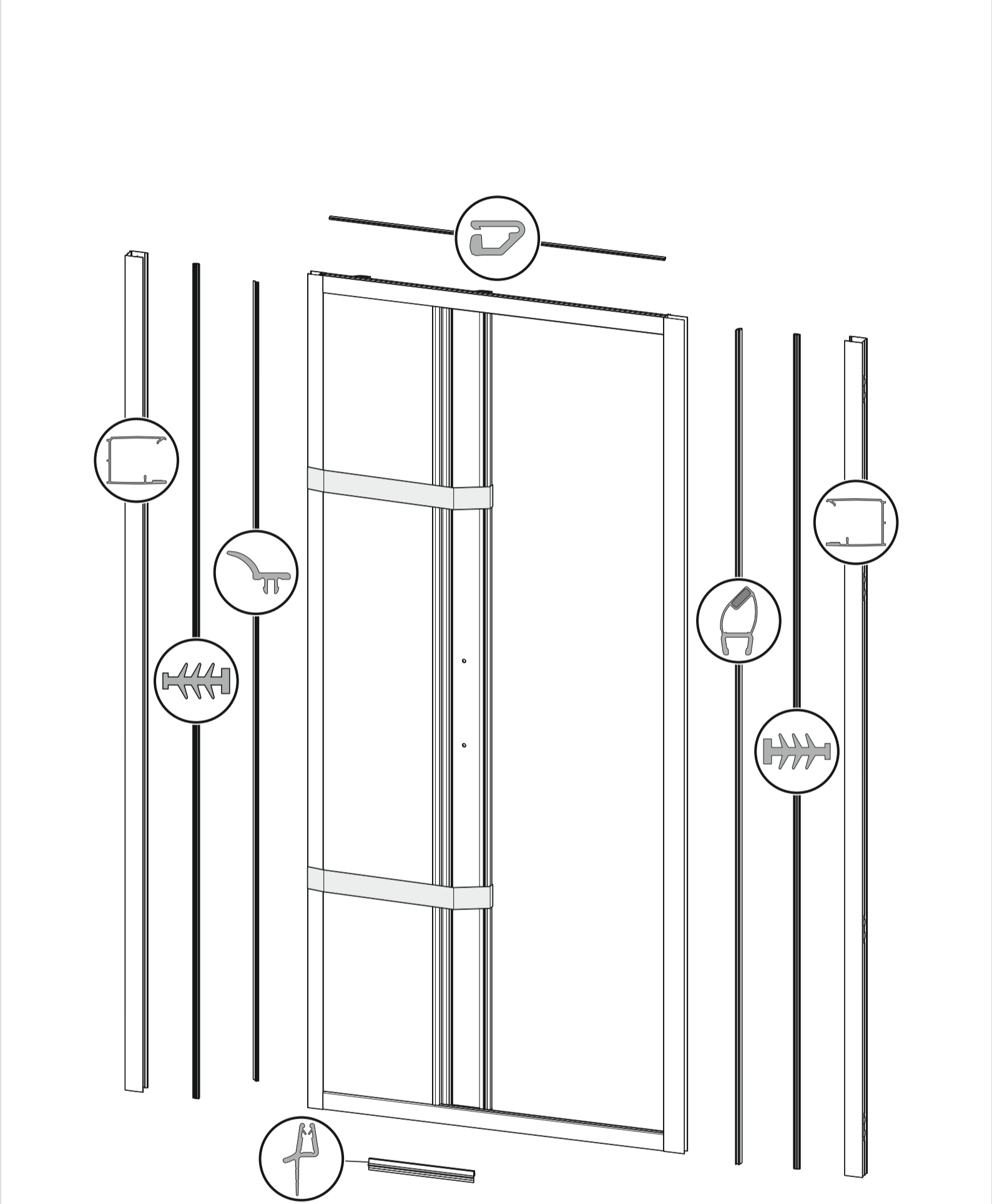
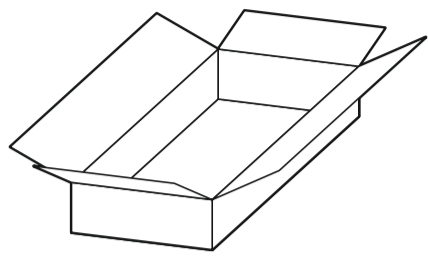
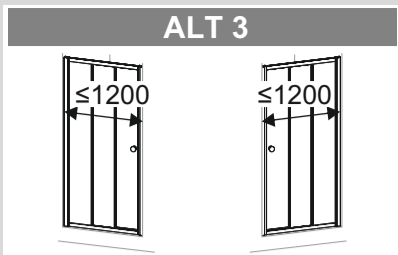
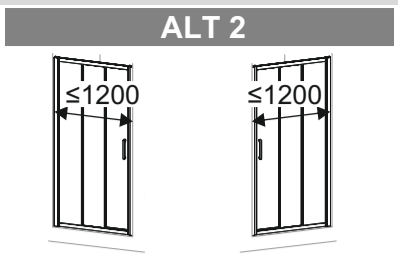
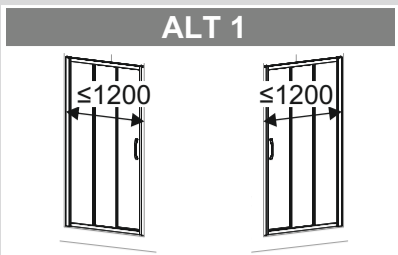

**ALT 1**

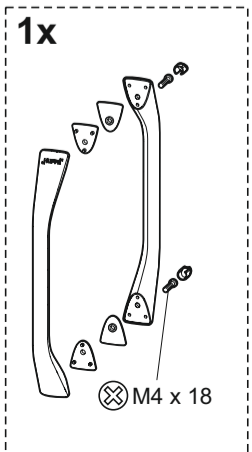

**ALT 2**

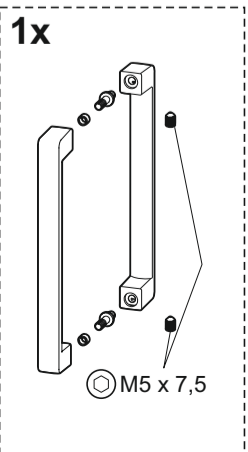

**ALT 3**

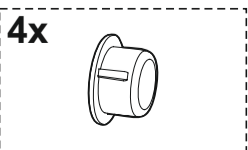
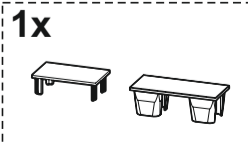
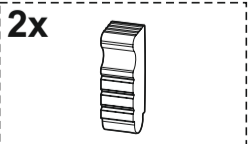
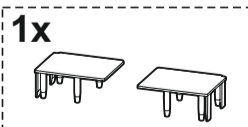
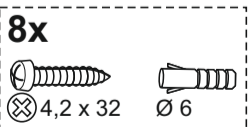
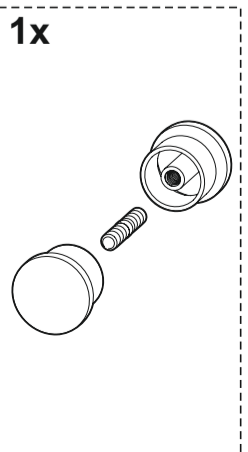

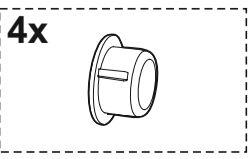
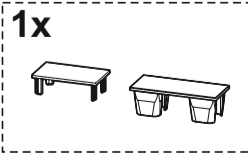
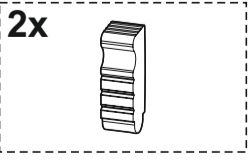
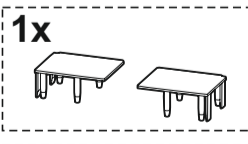
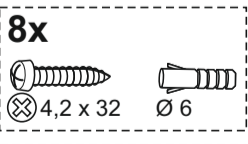
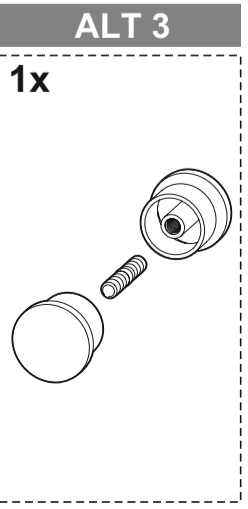
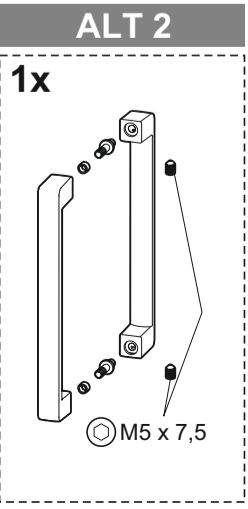
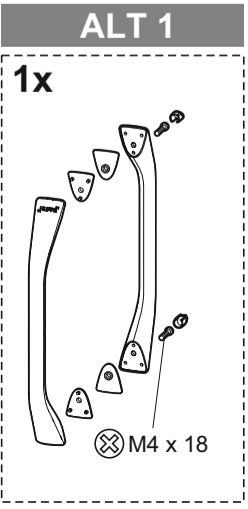
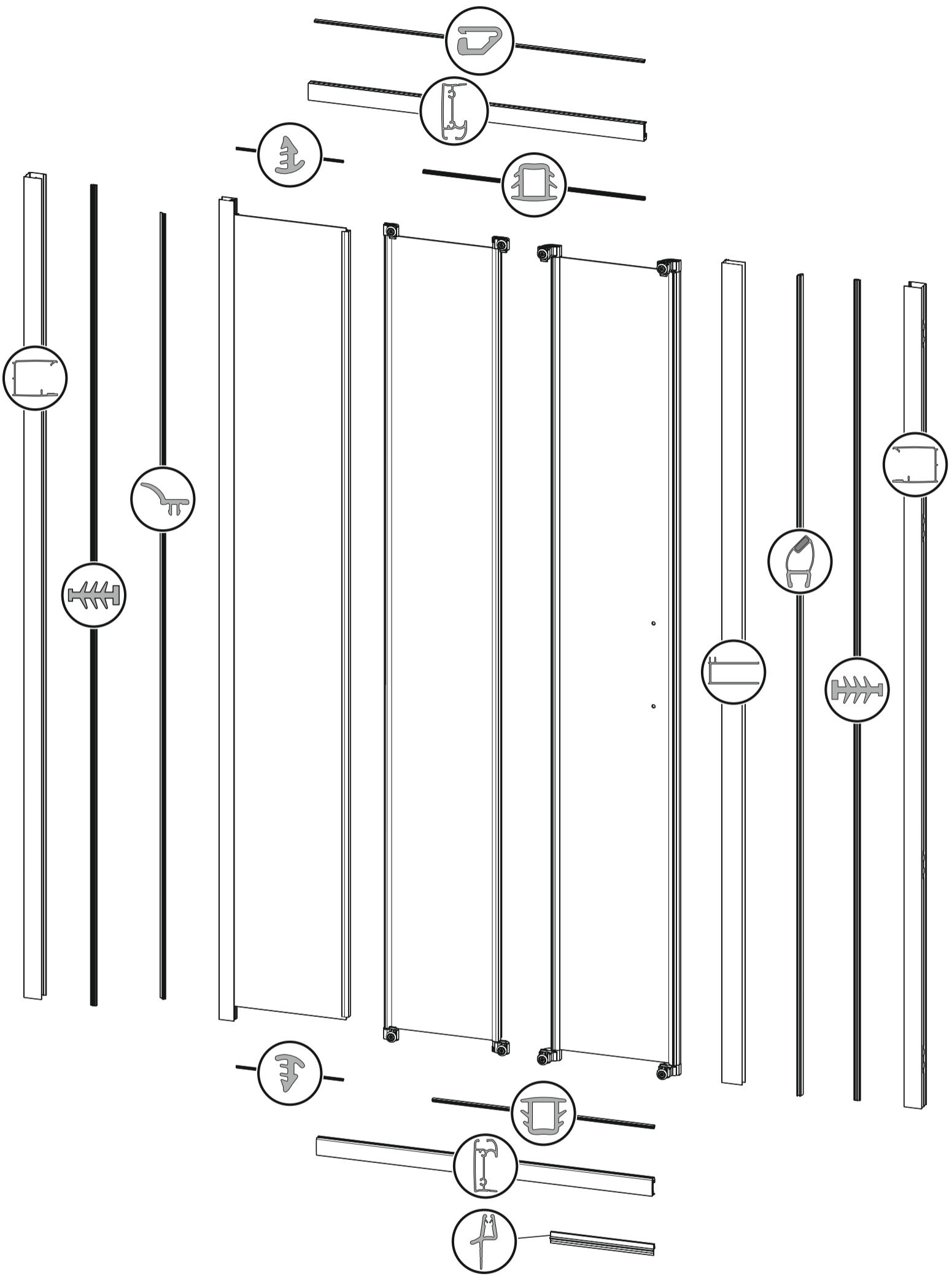
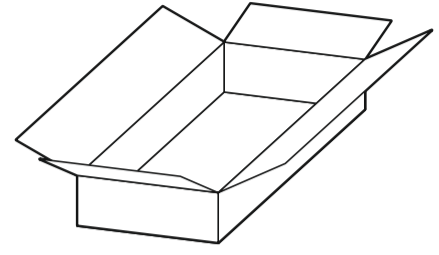
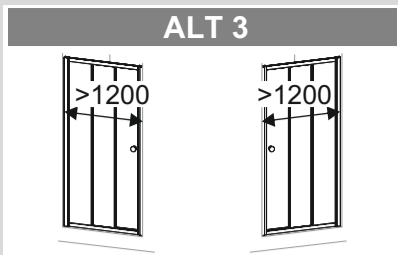
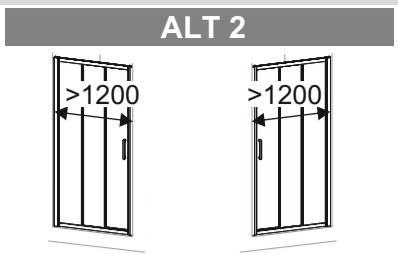
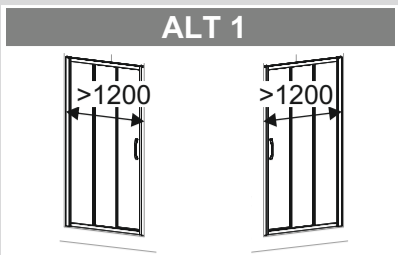

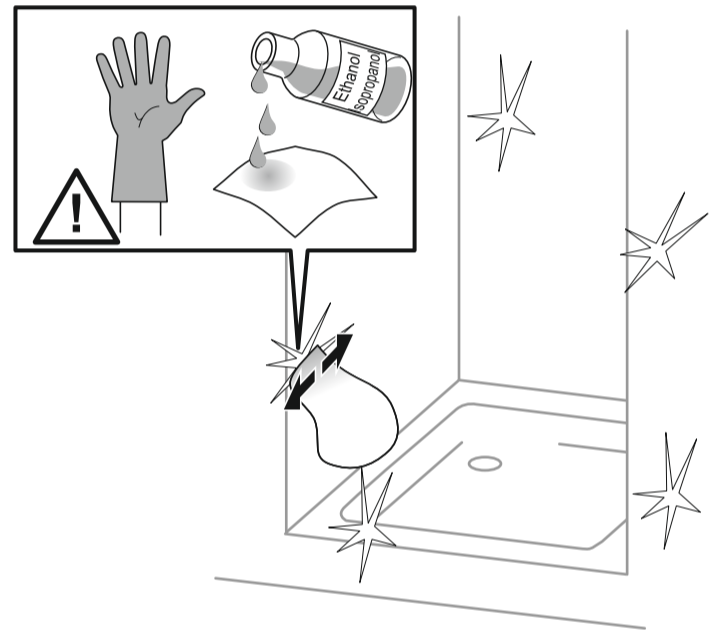
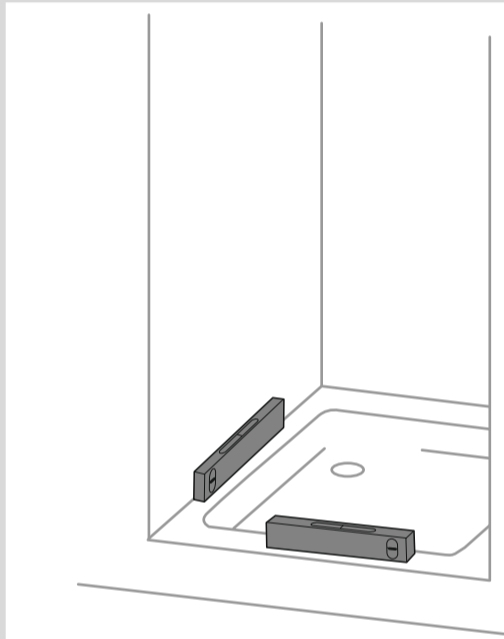
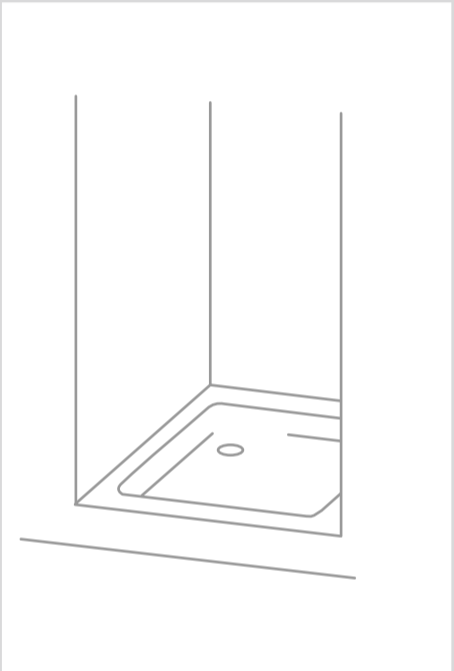
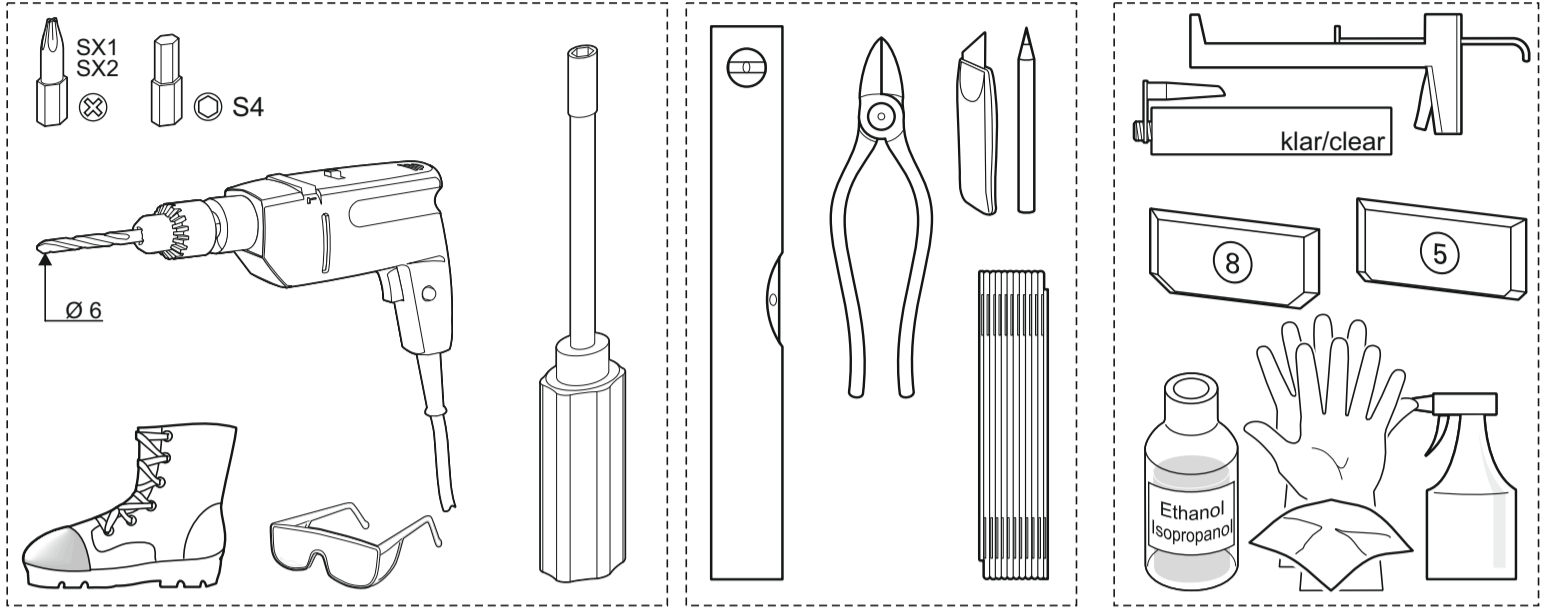
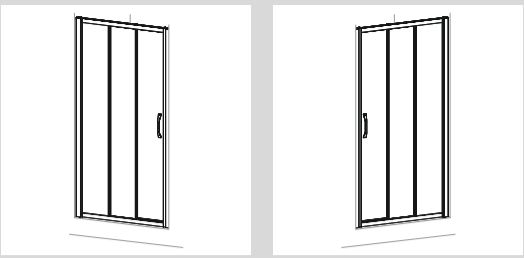

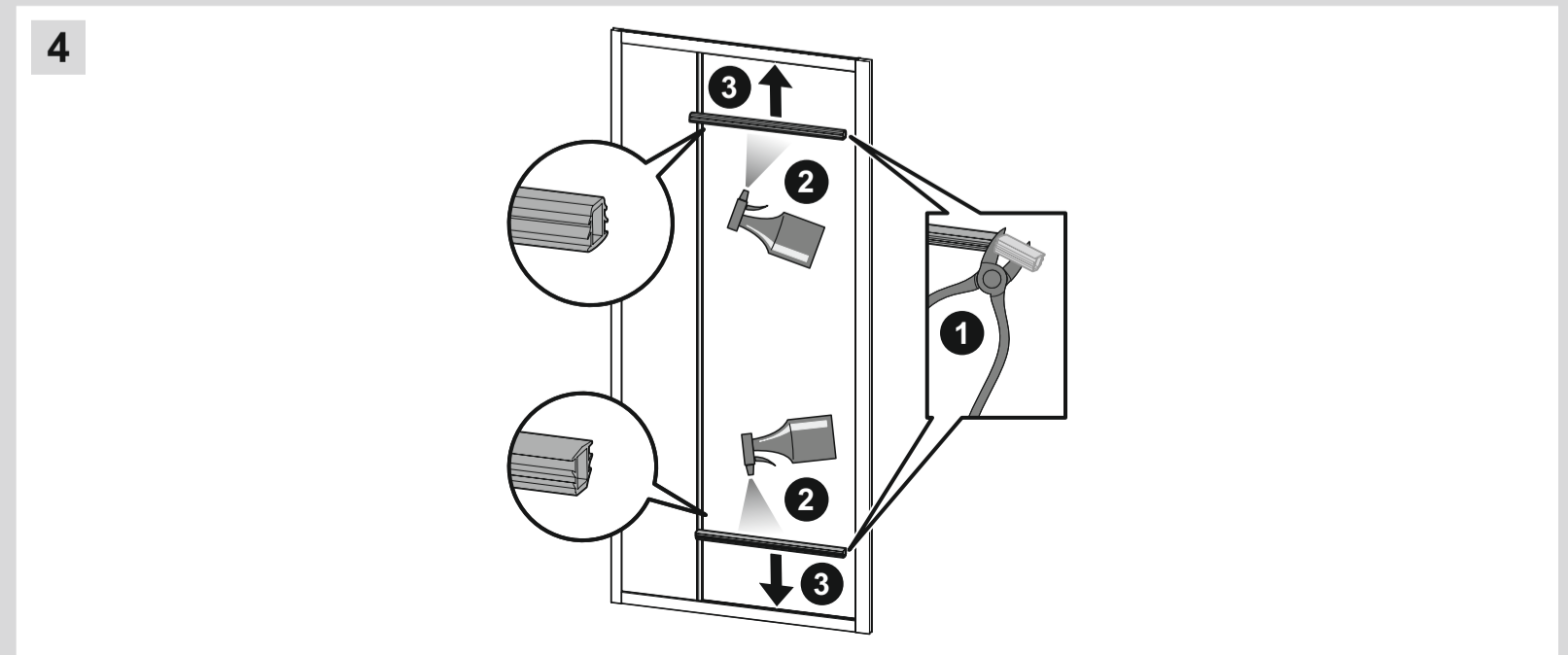
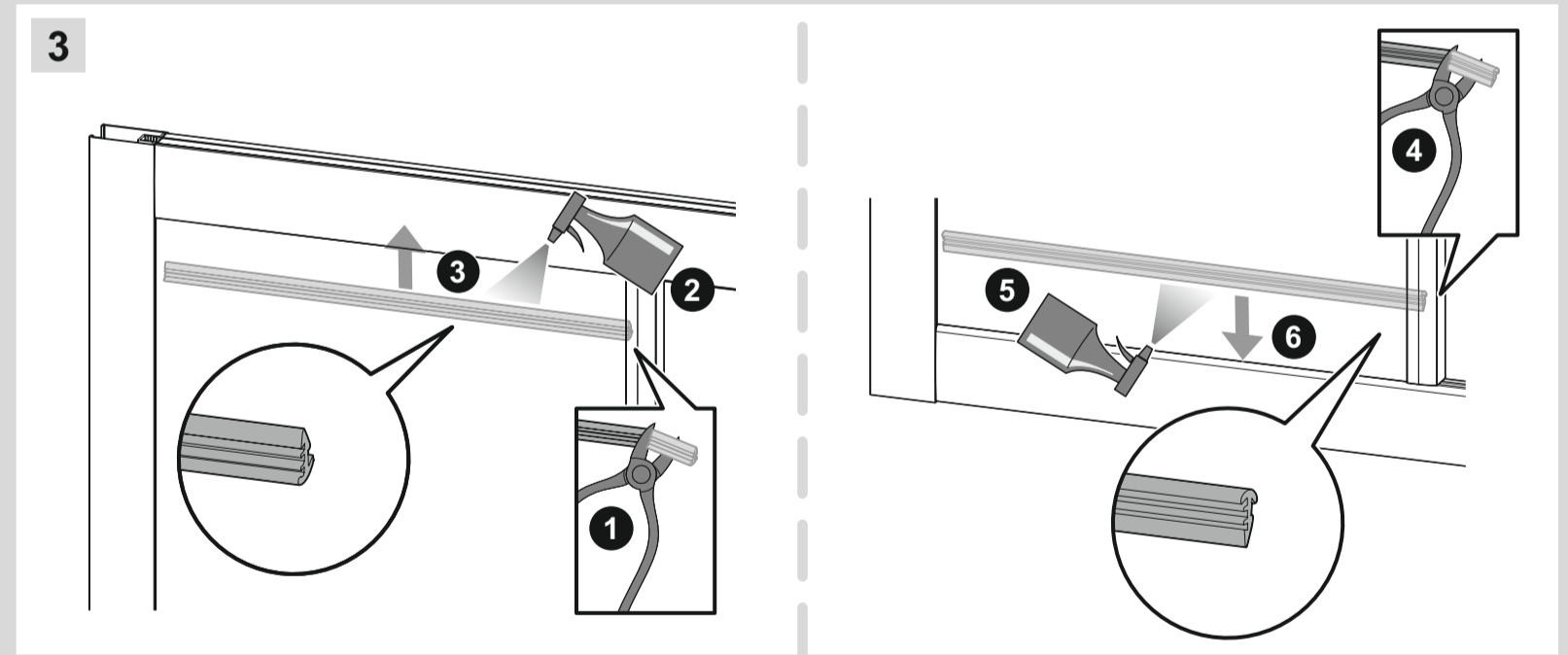
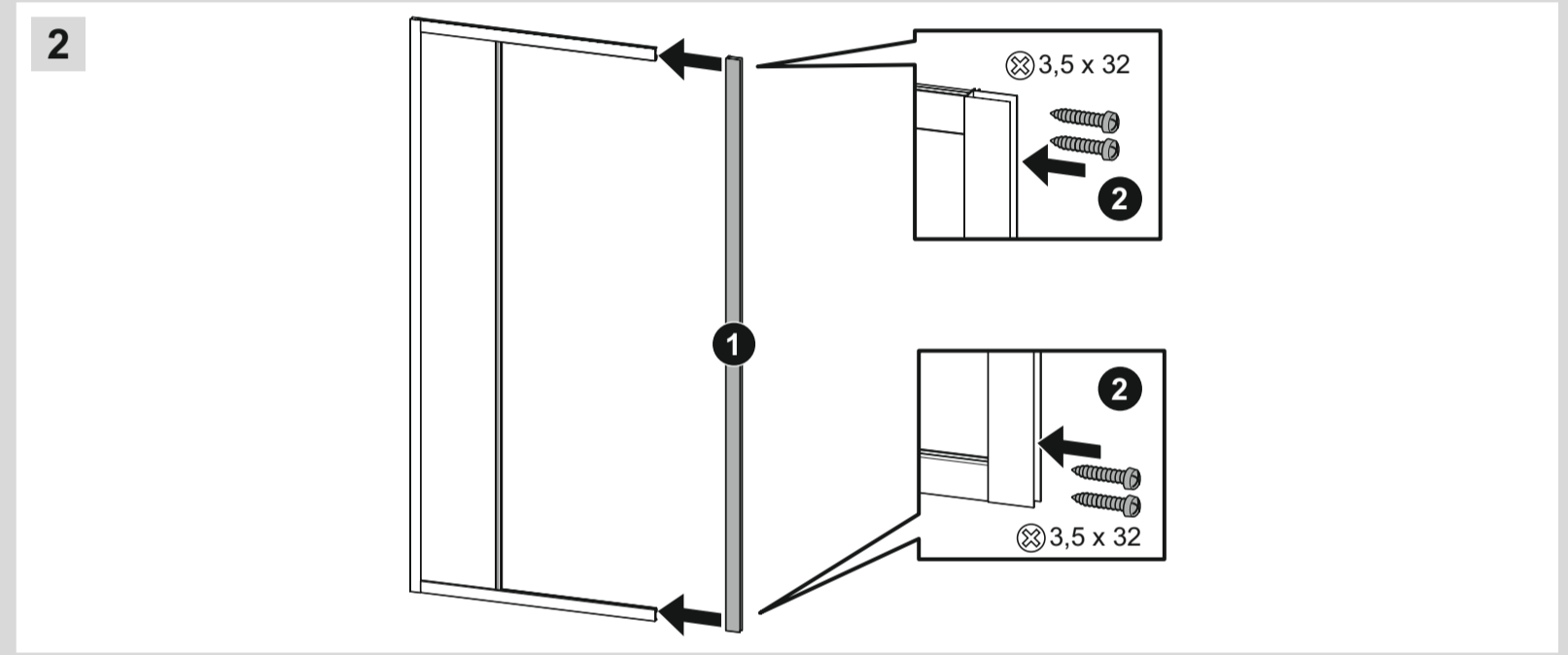
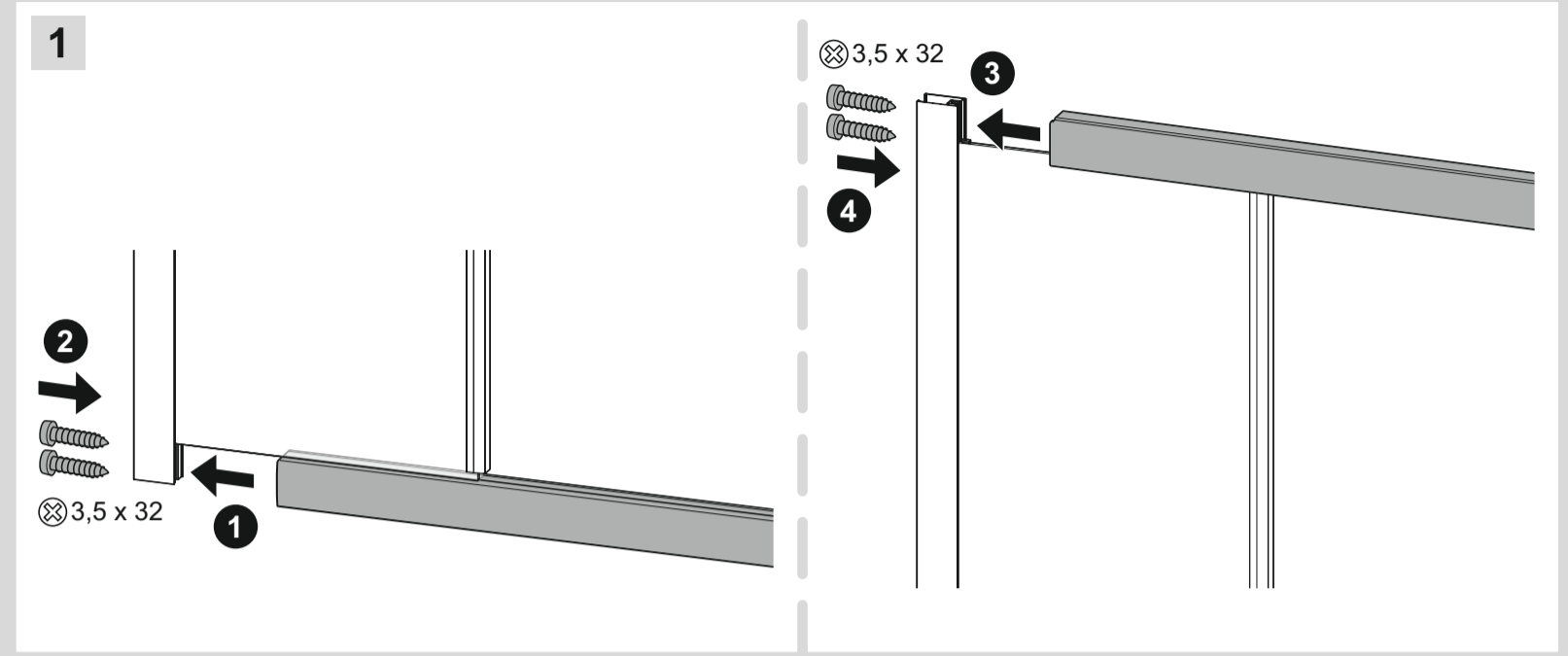
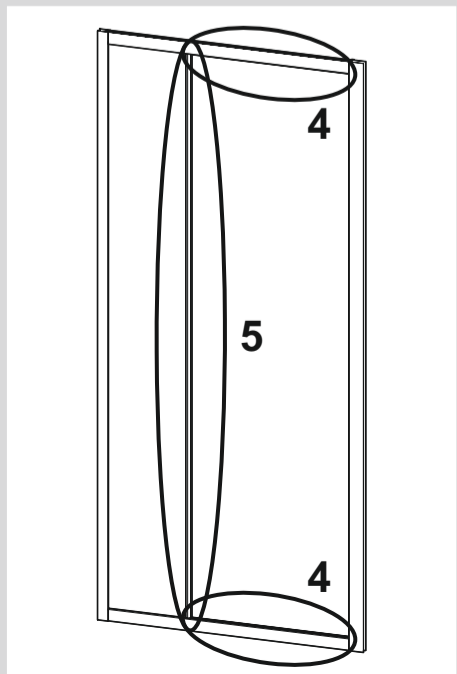
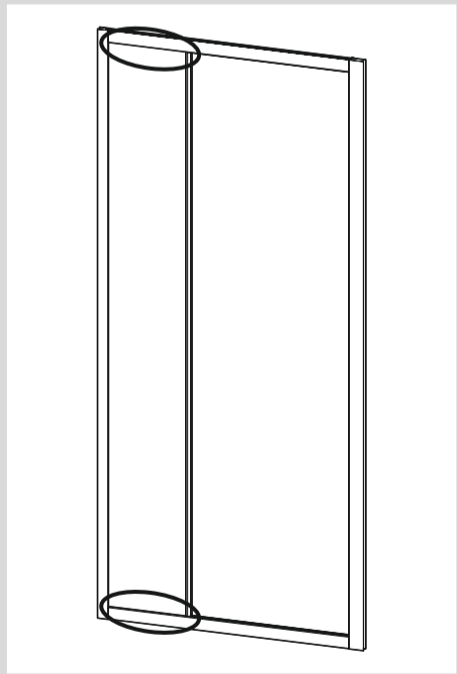
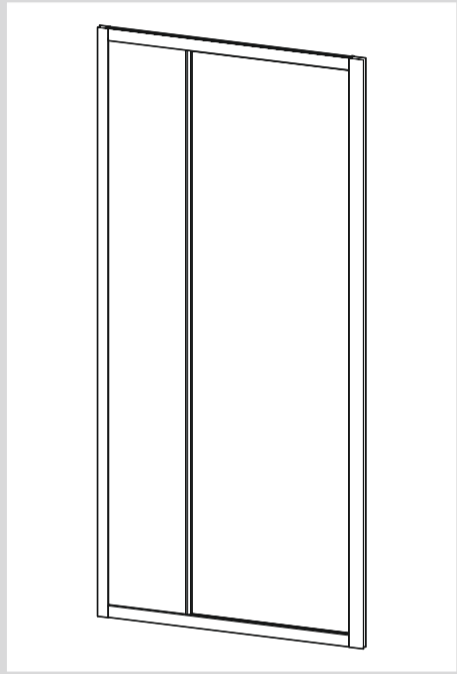
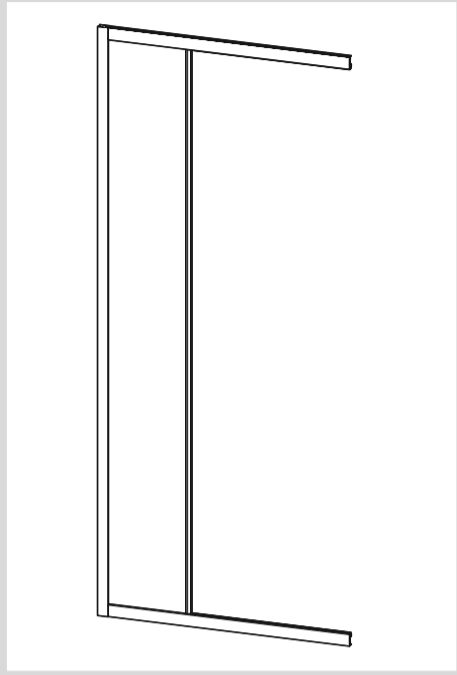
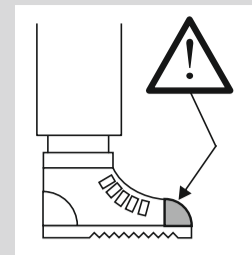
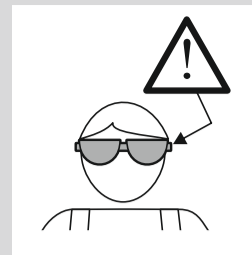
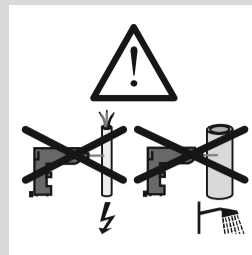
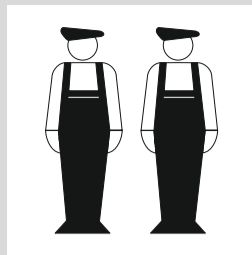
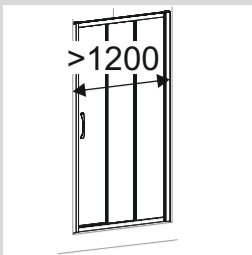

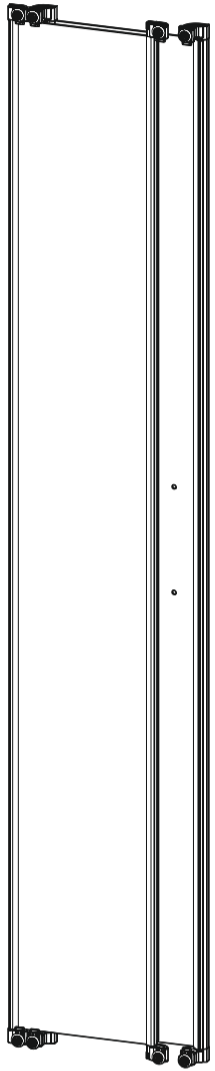
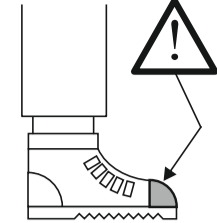
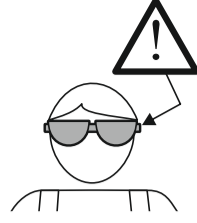
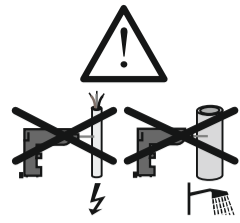
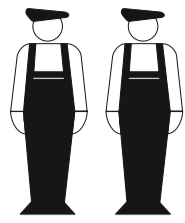
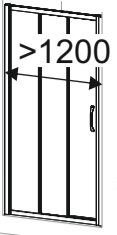

5

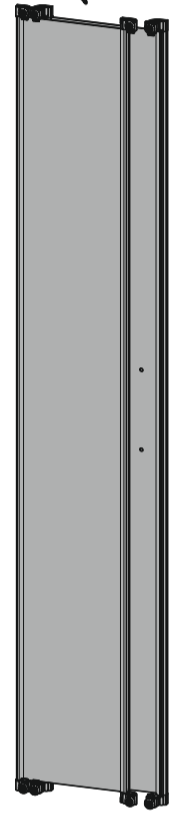
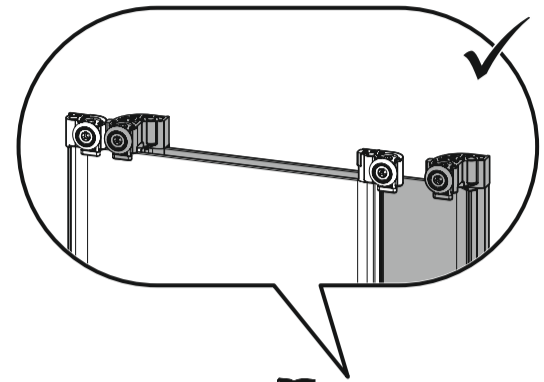
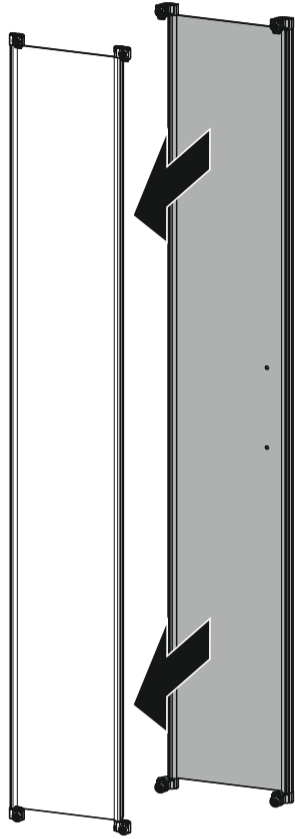

6

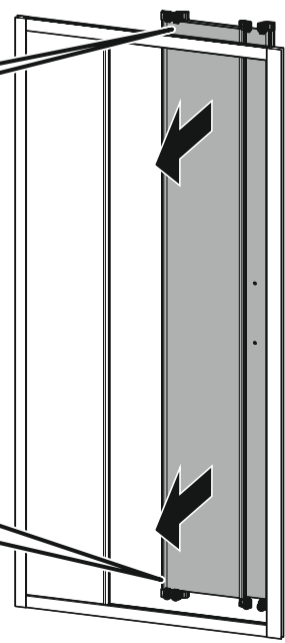
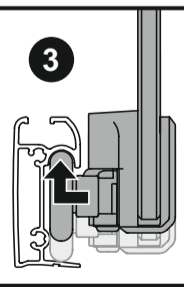
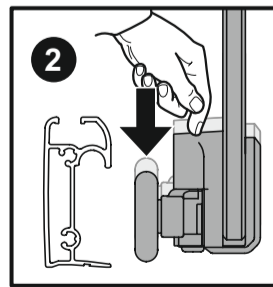
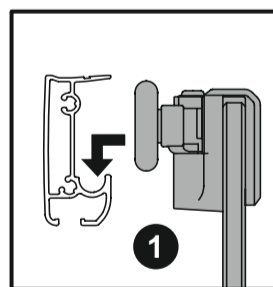
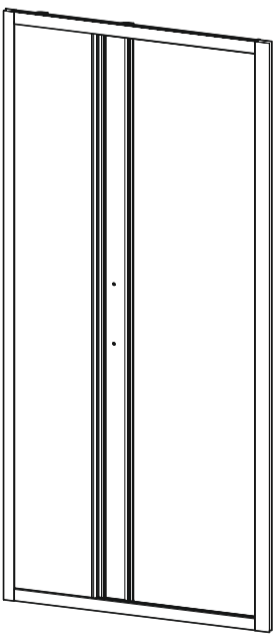

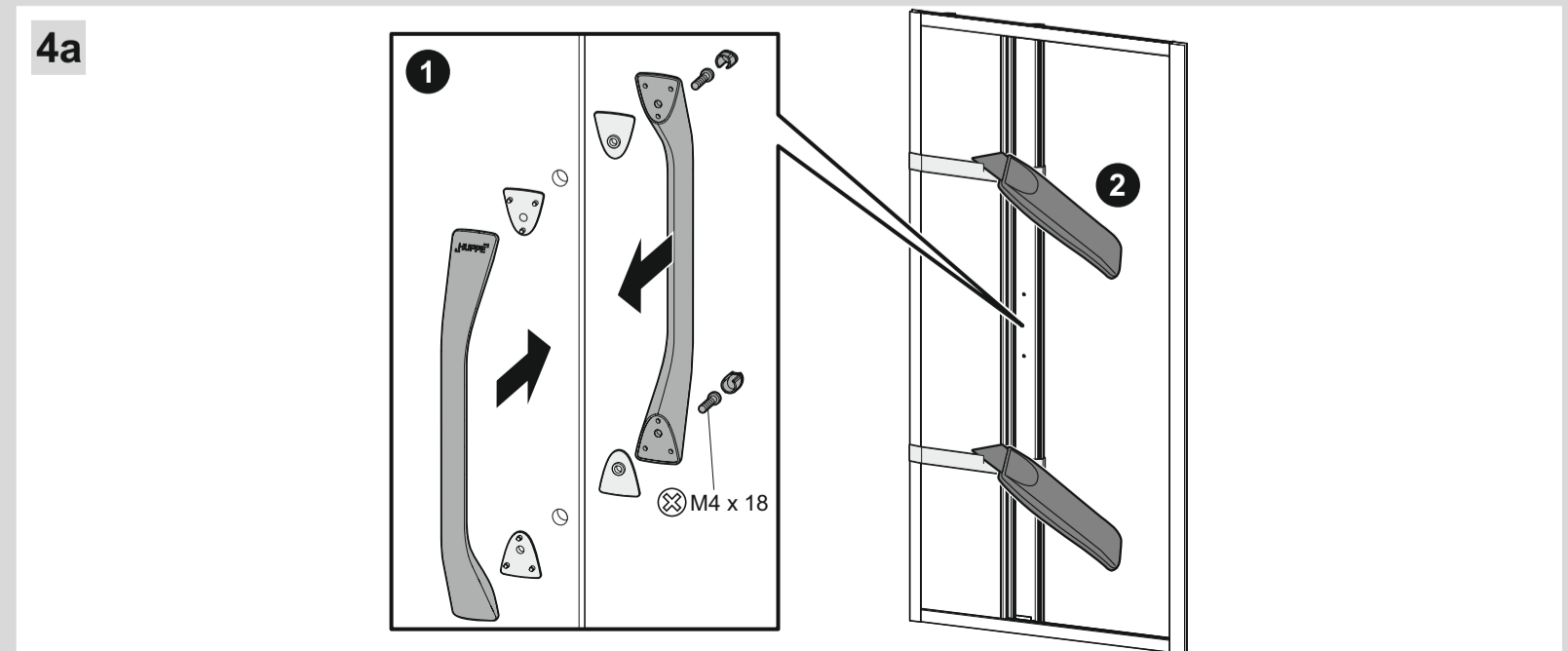
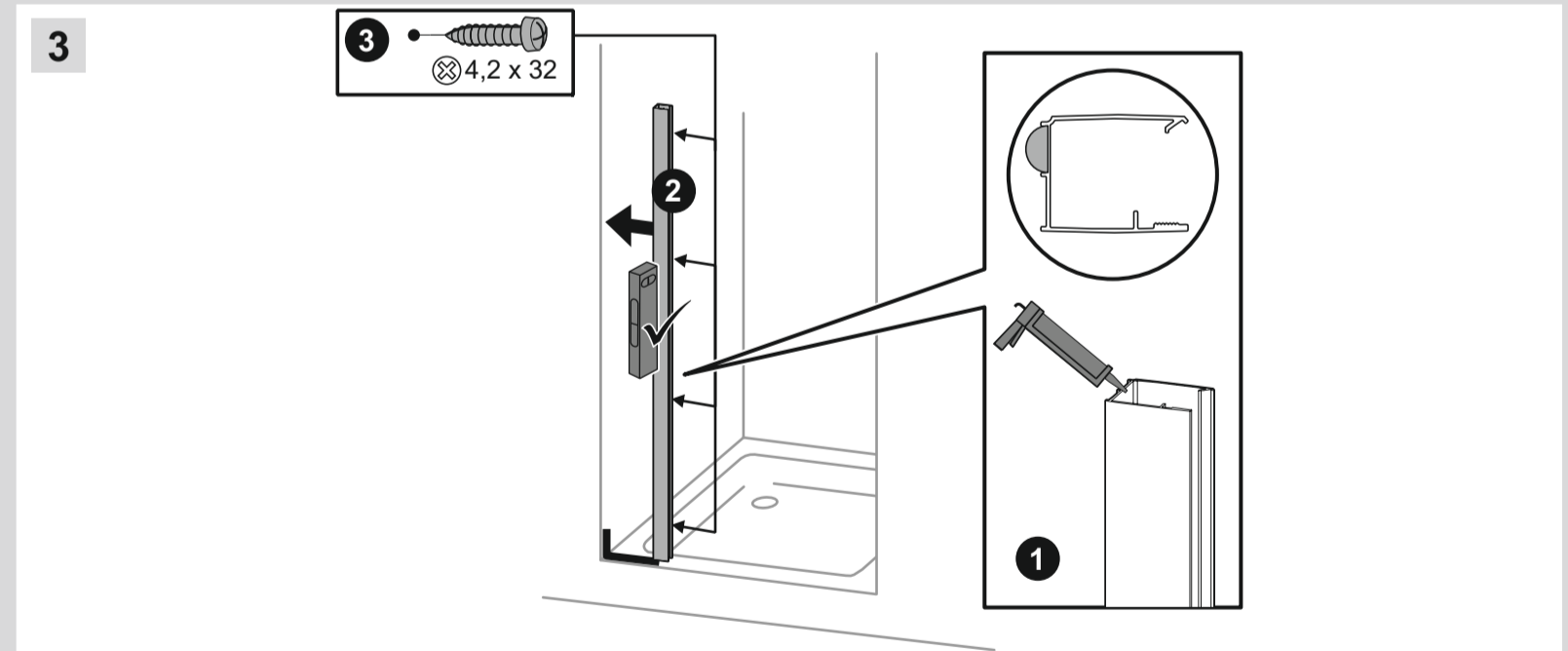
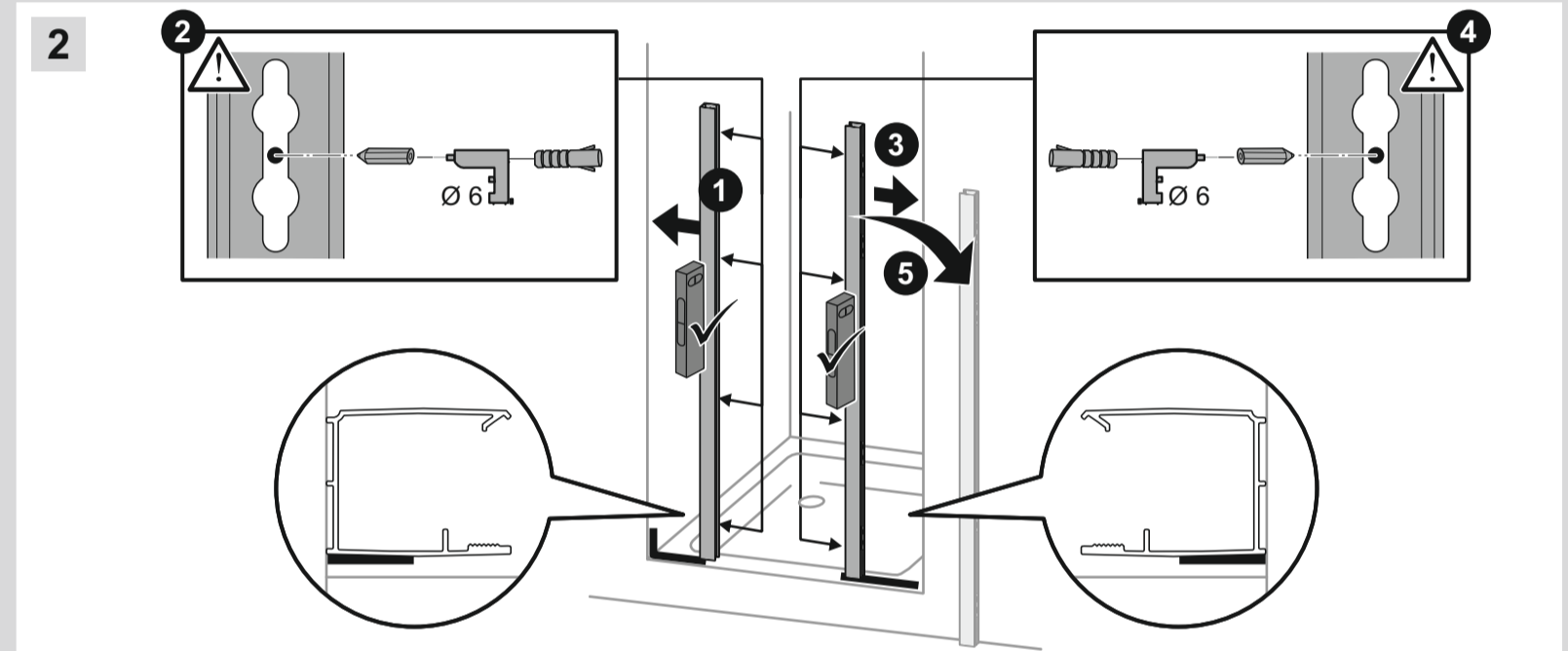
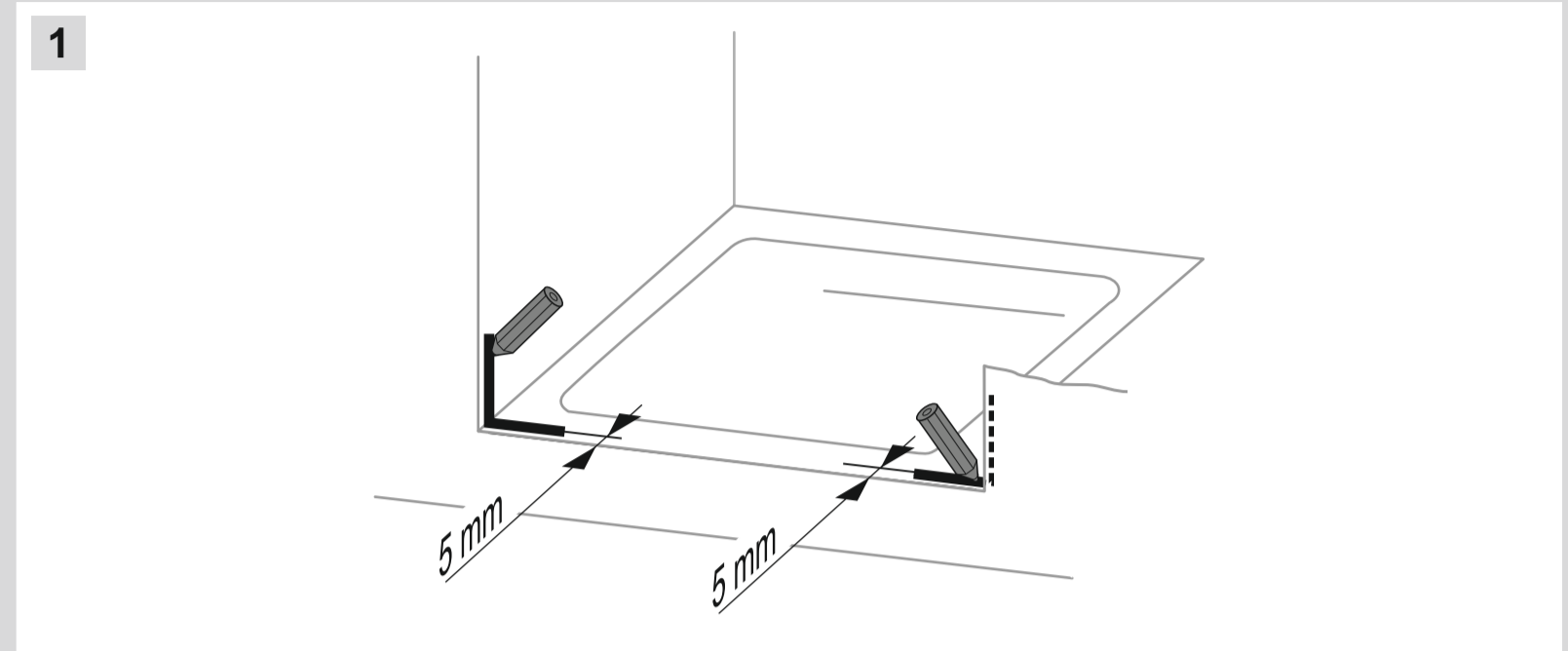
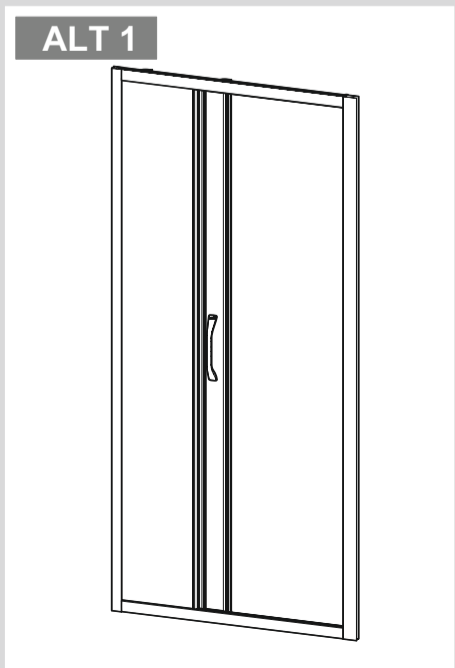
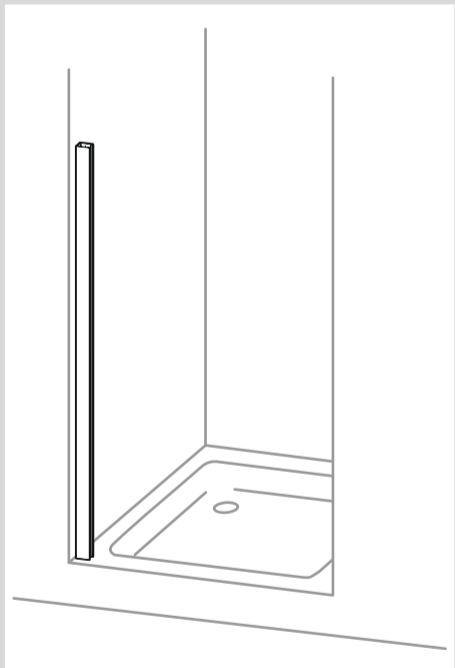
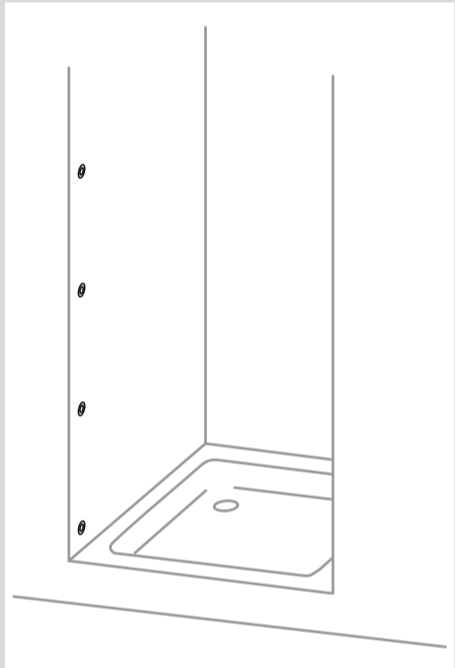
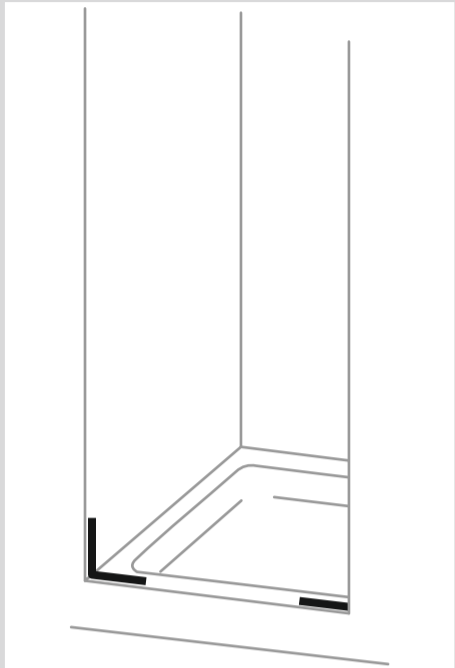
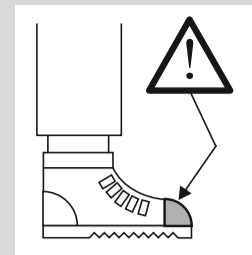
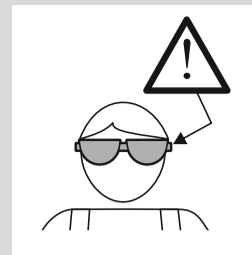
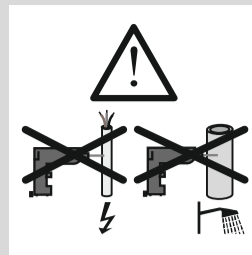
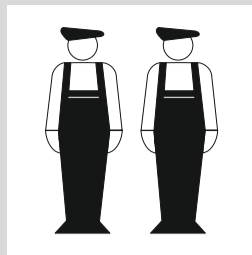

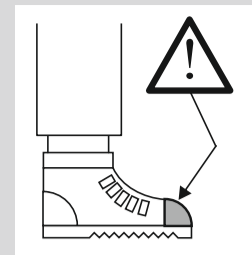
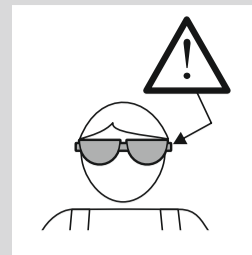
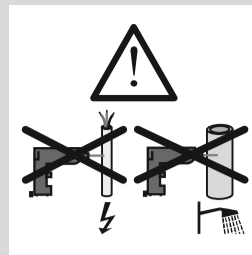
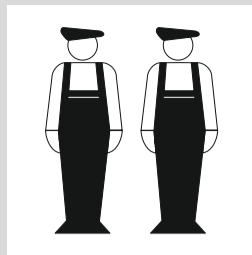

ALT 2

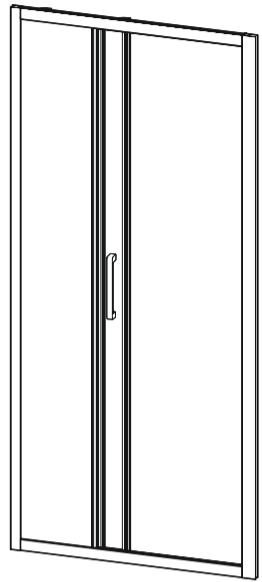

4b

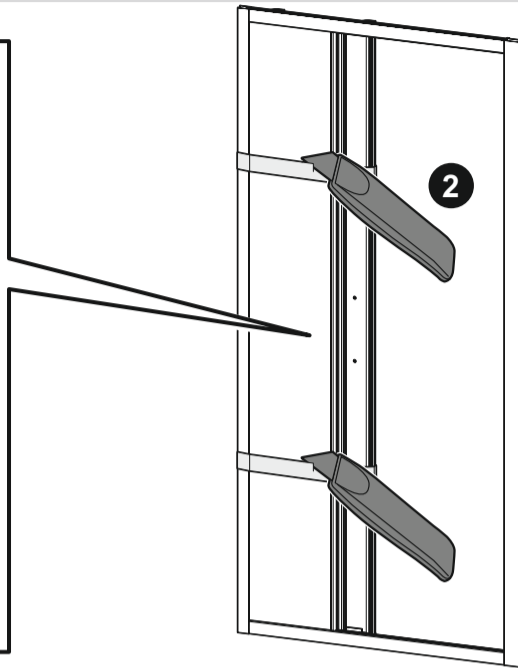
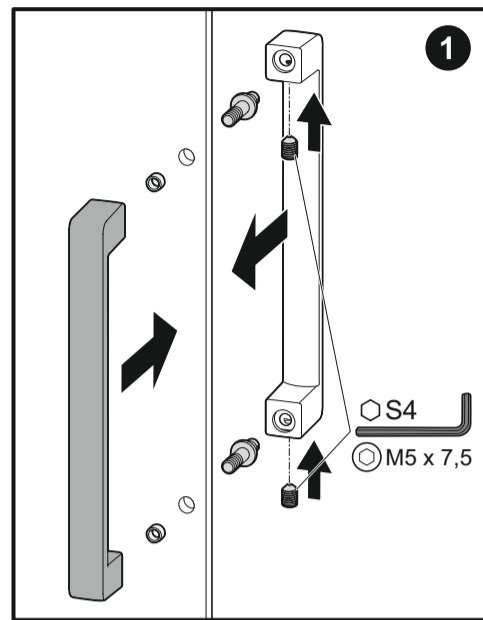

ALT 3

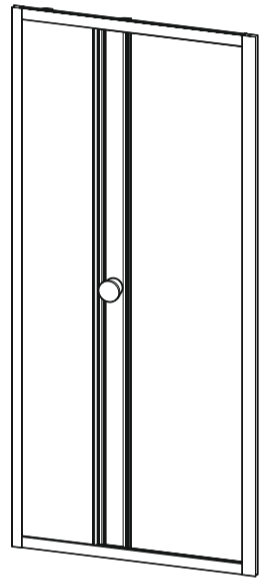

4c

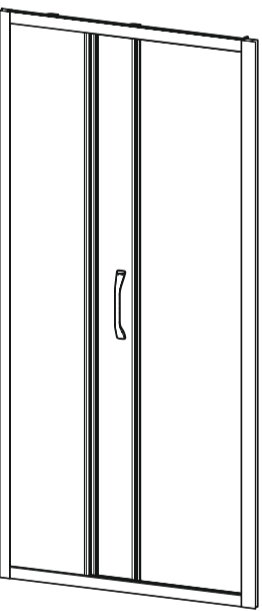
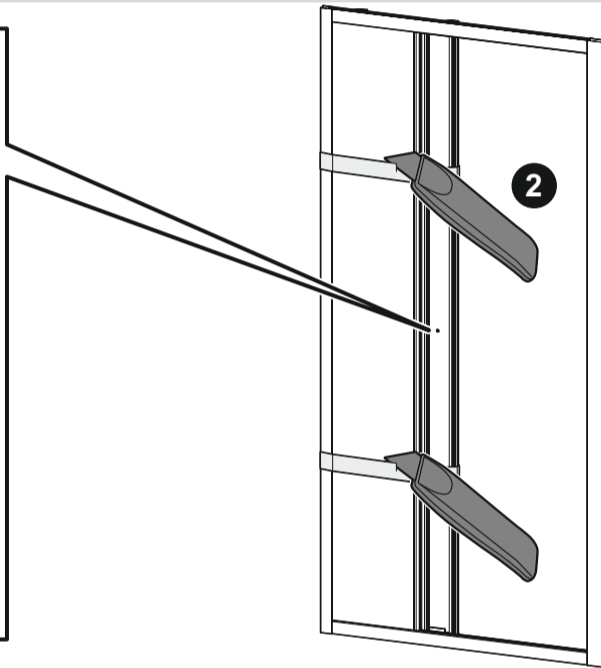
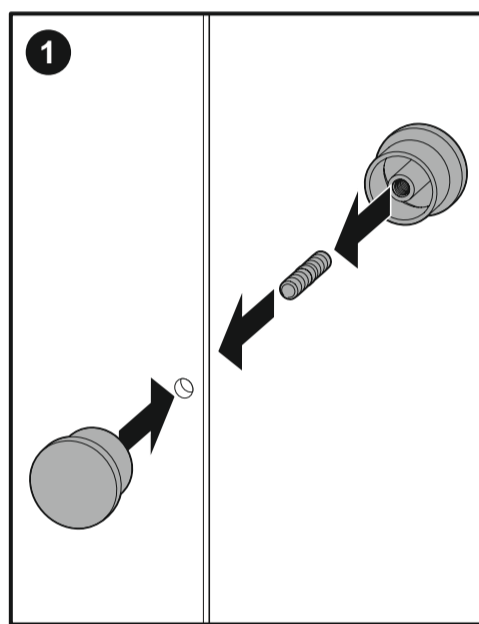

5

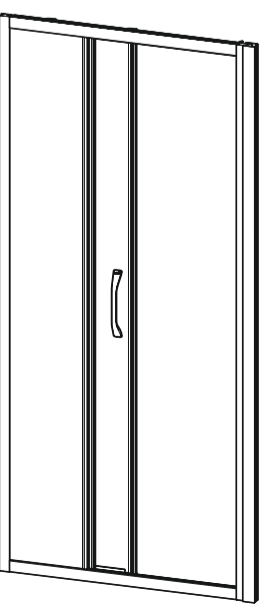
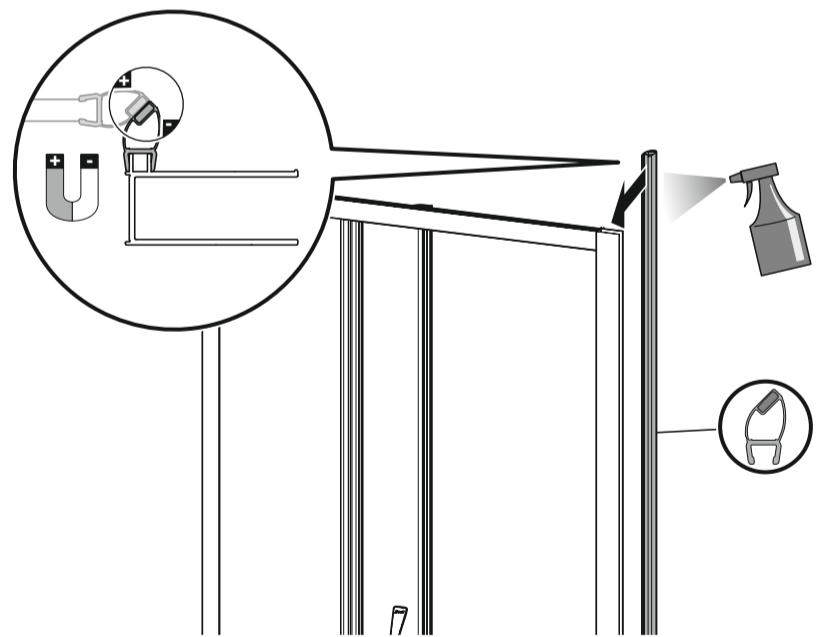

6

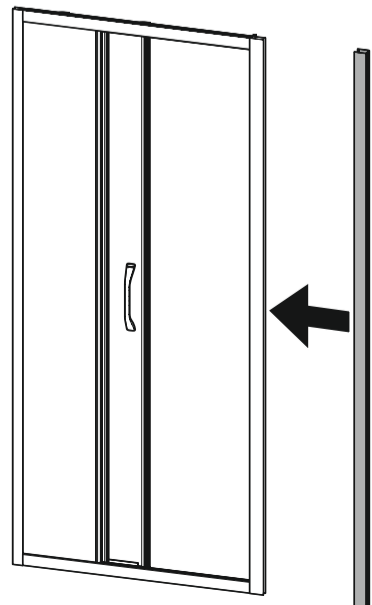

7

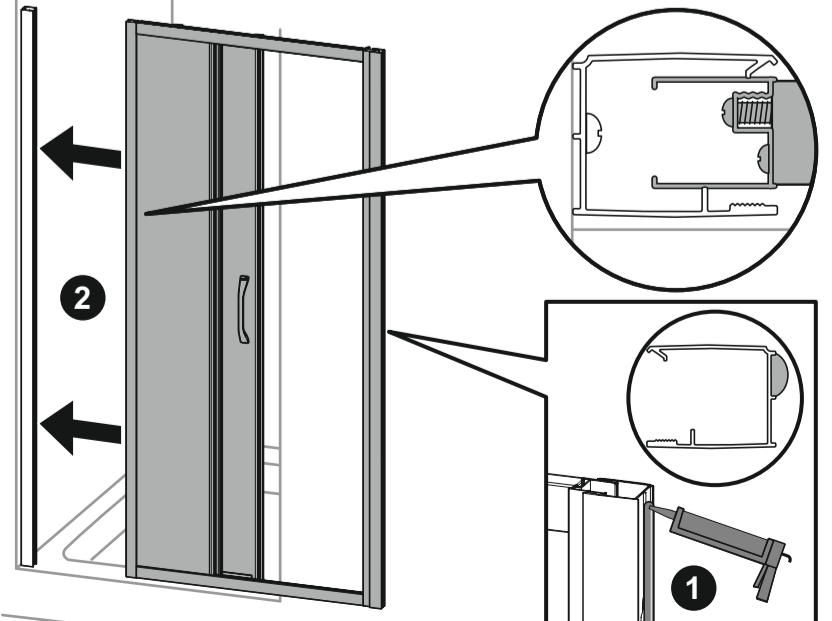



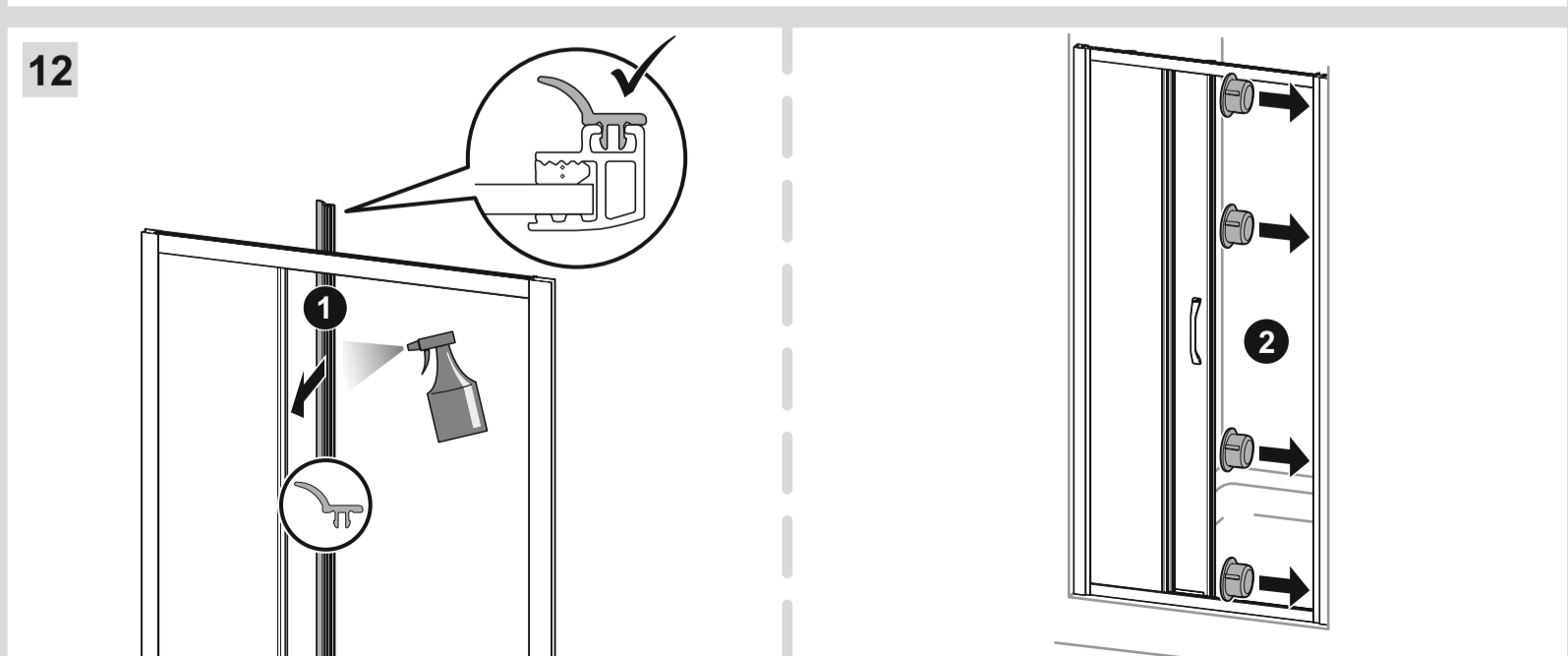
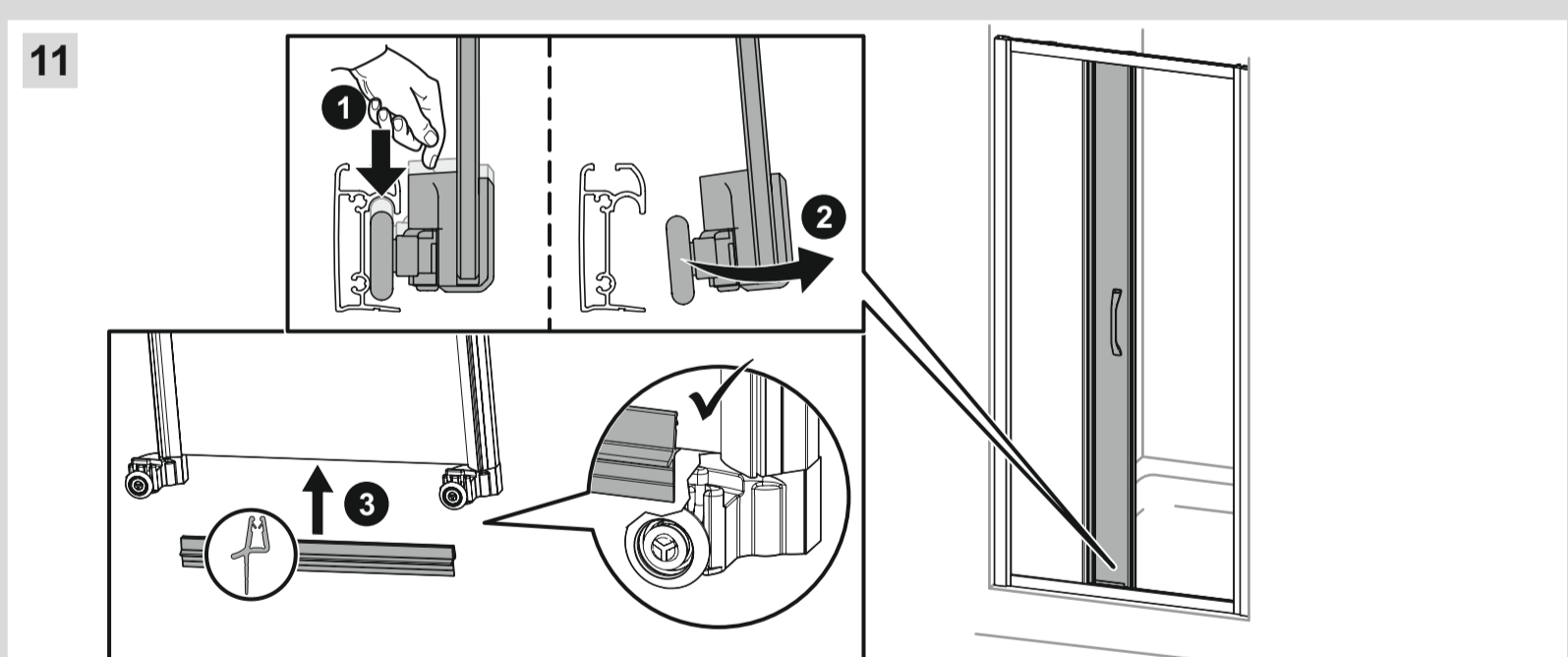
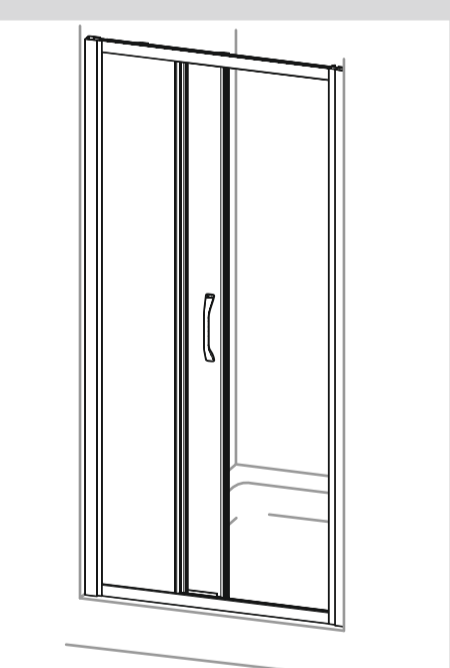
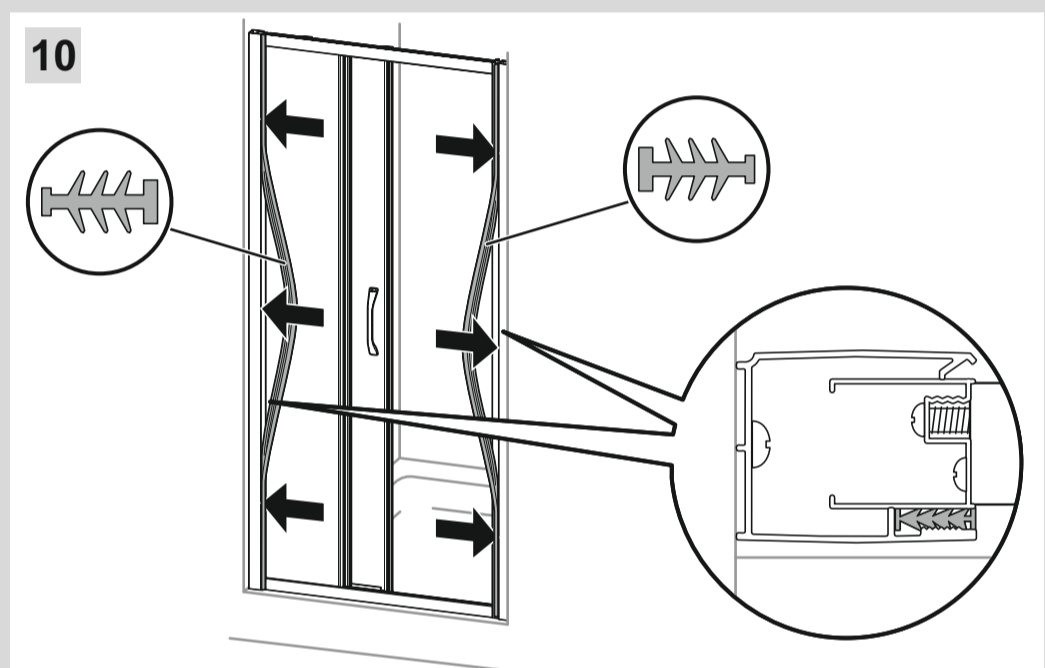
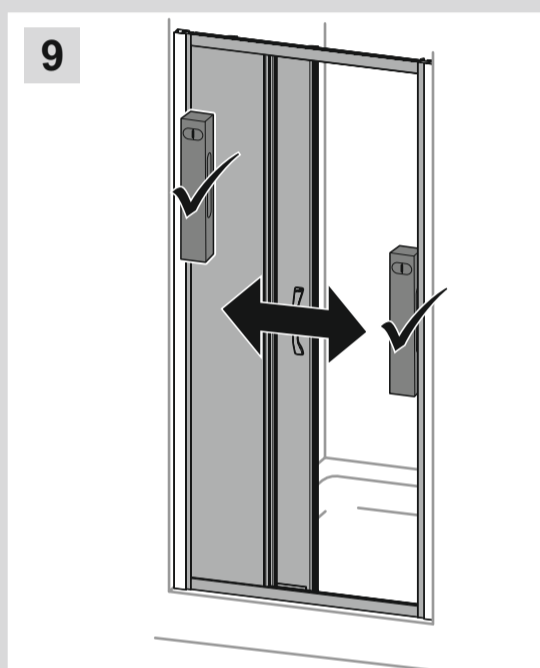
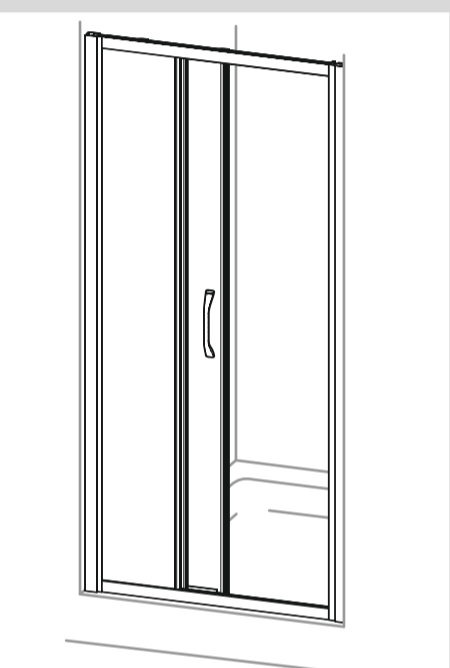
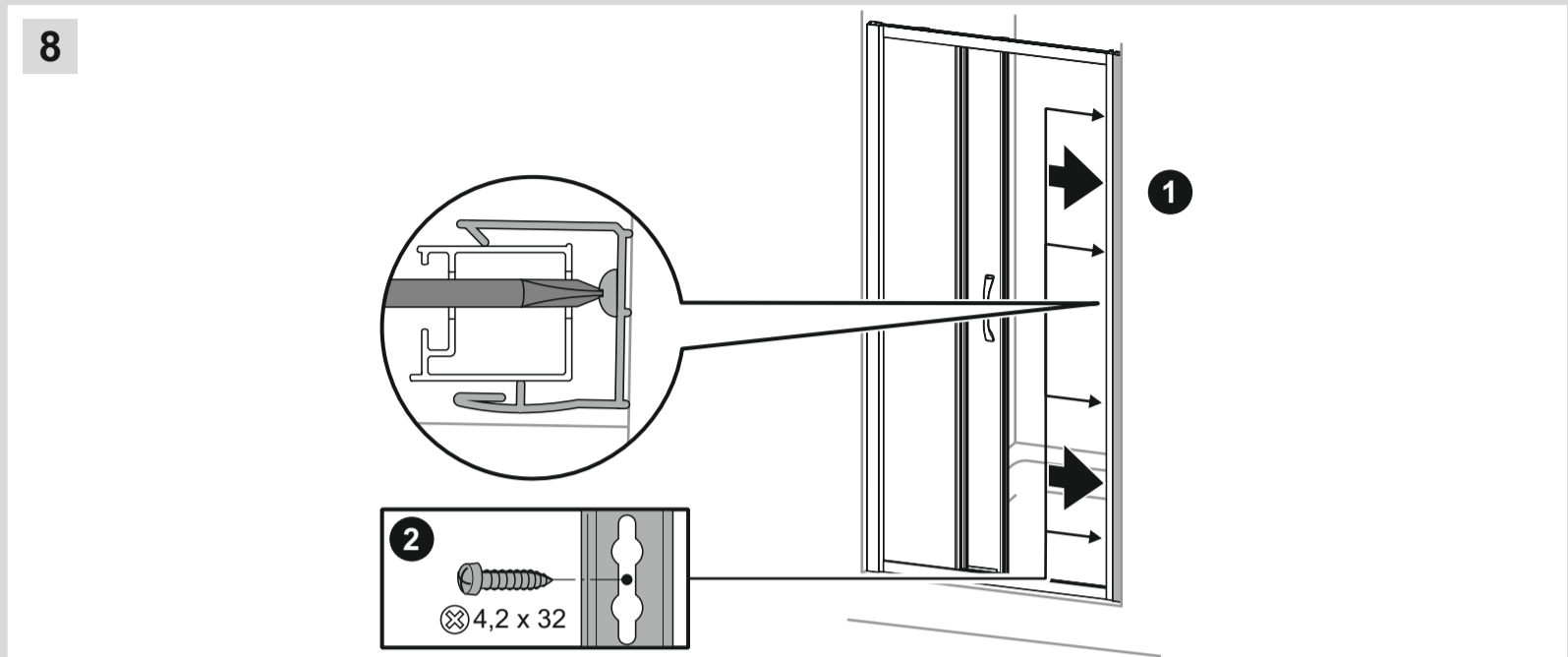
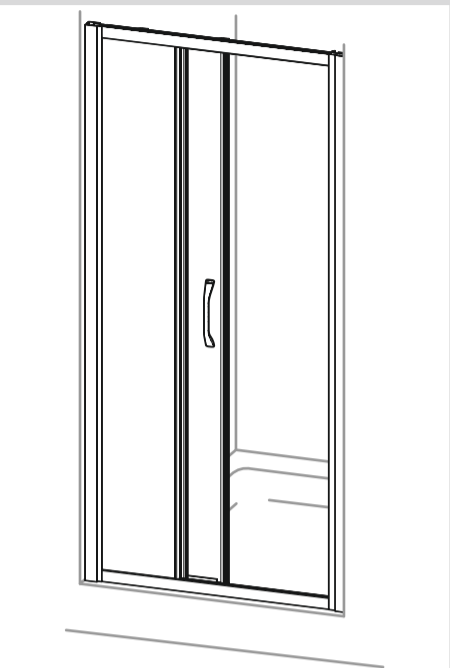
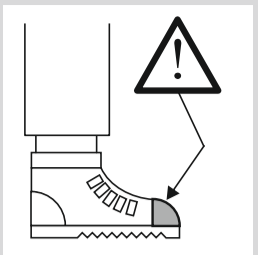
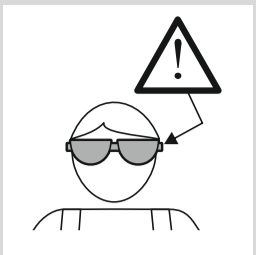
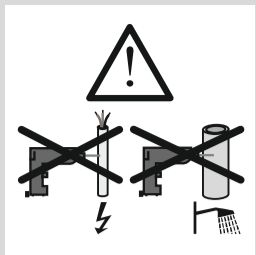
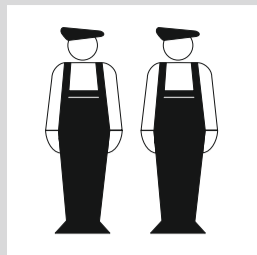
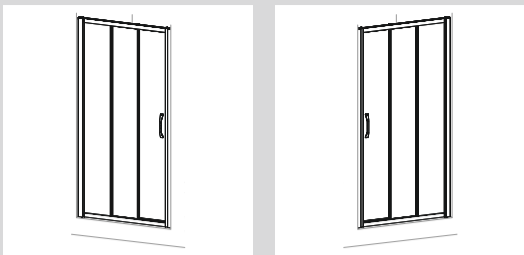

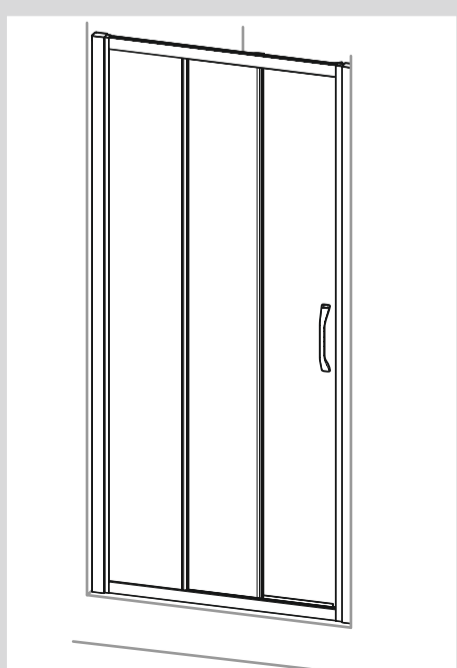
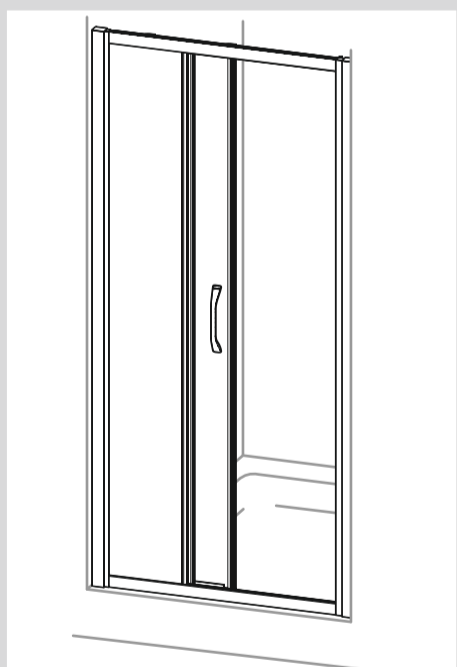
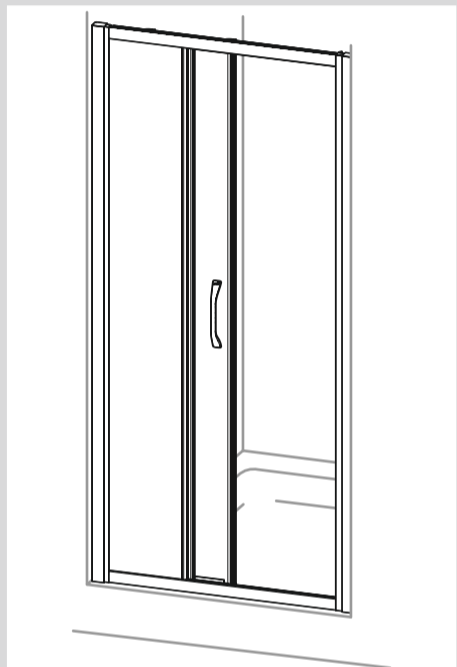
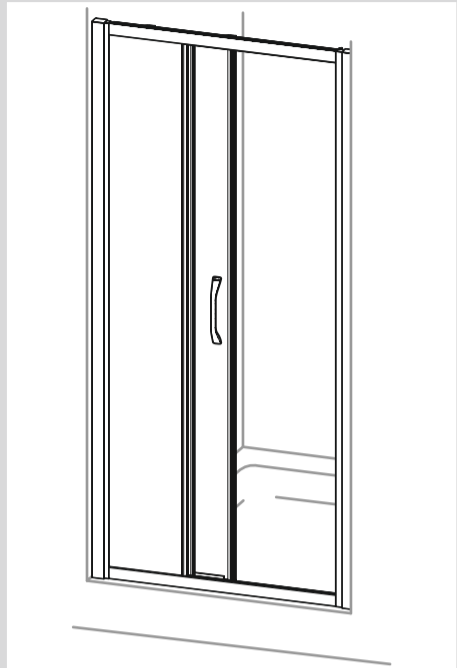
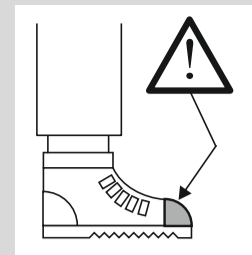
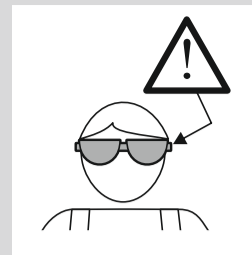
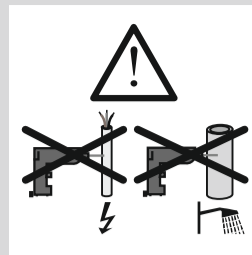
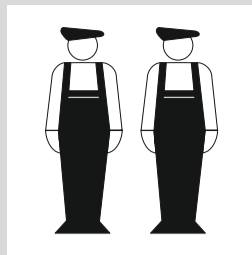

13

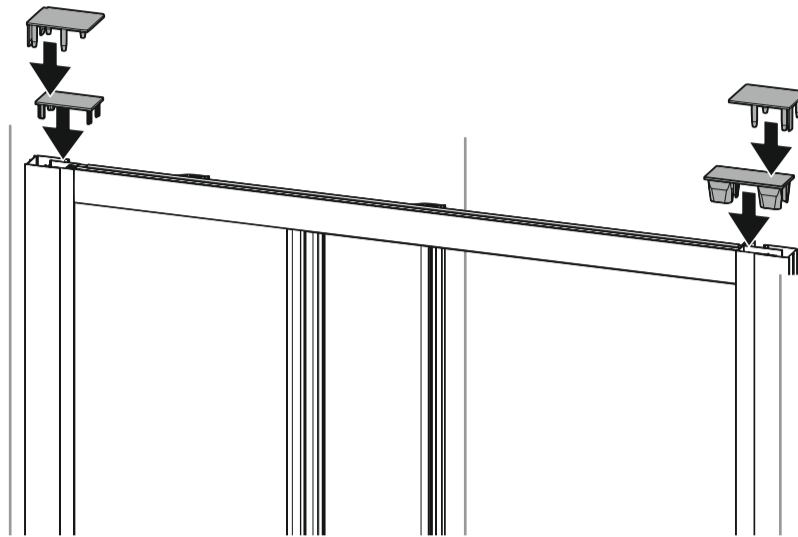

14

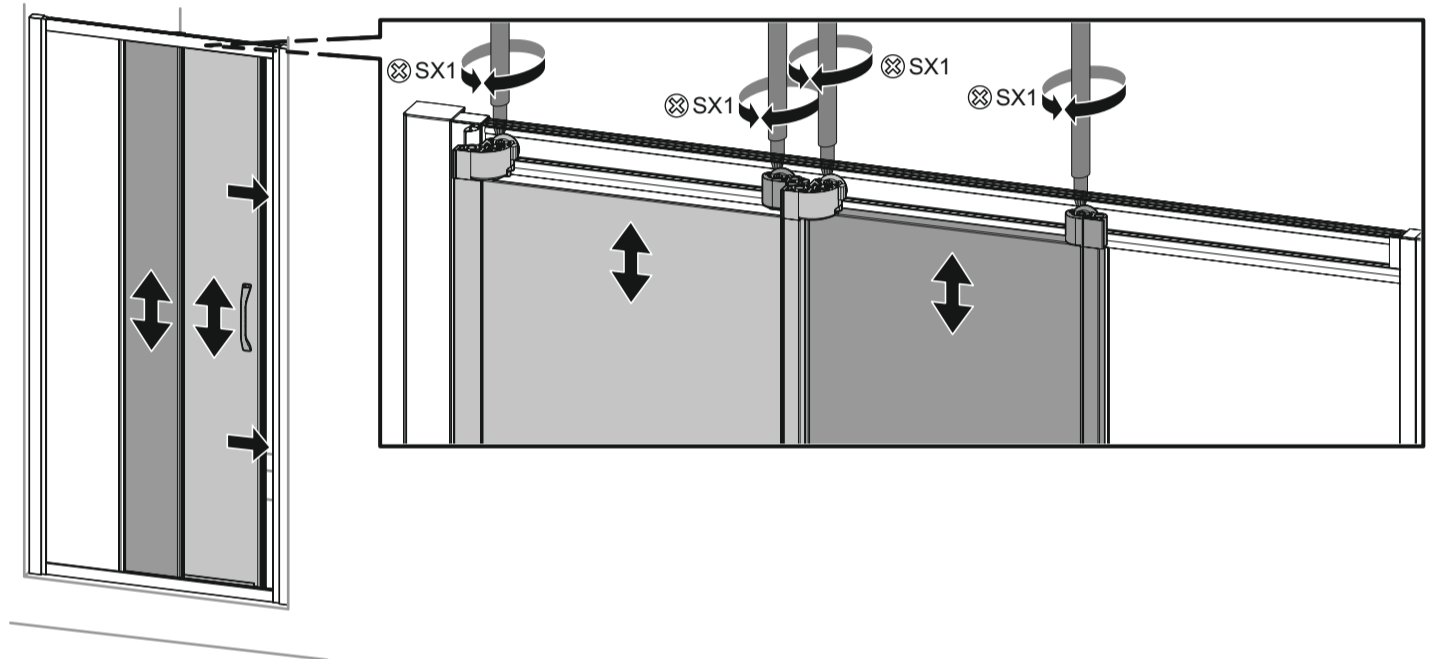

15

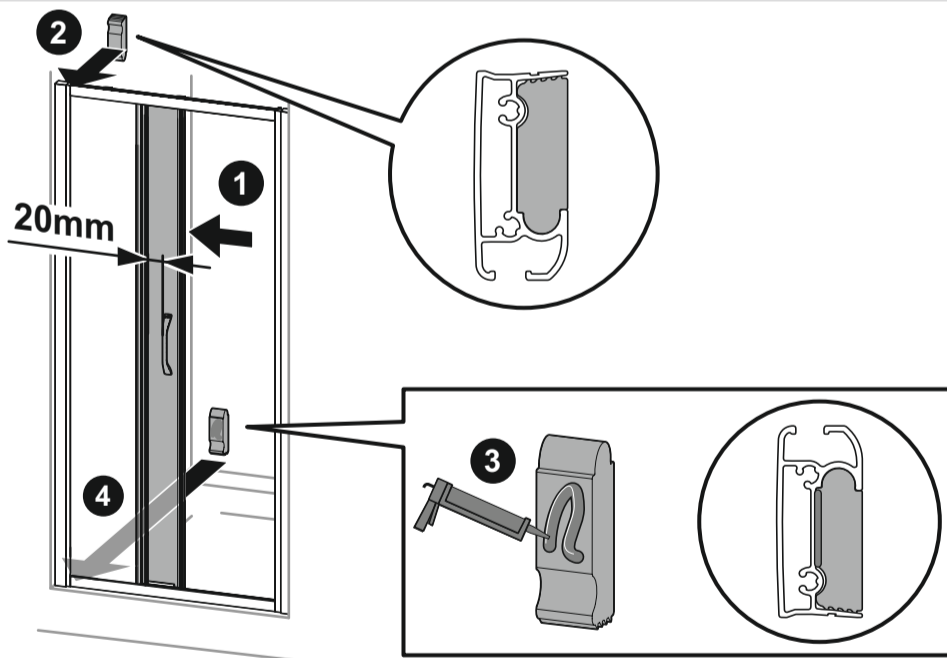

16

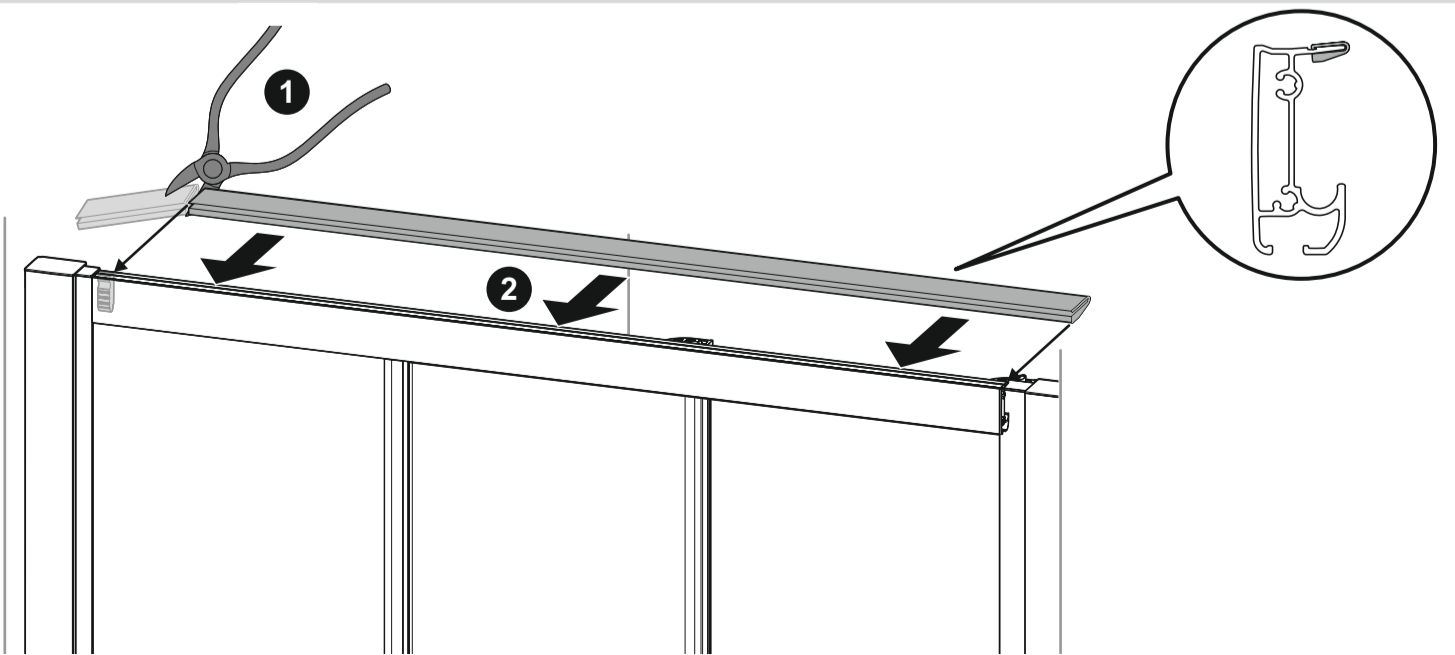

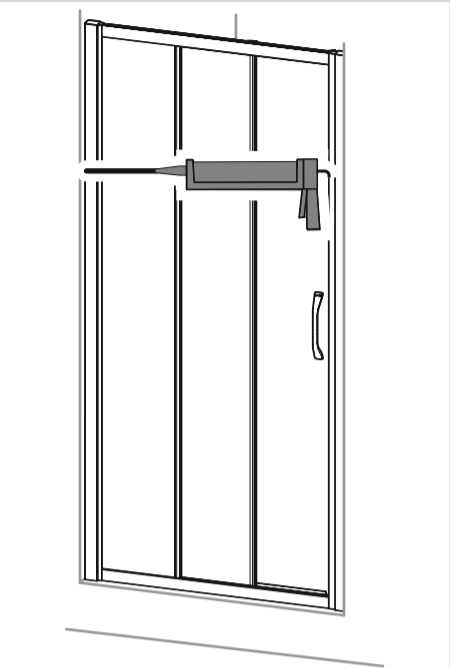
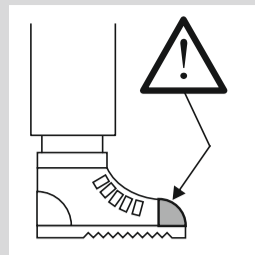
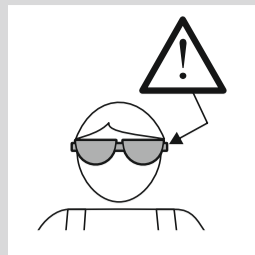
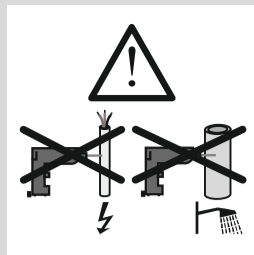
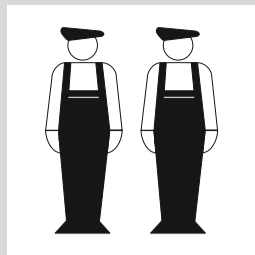
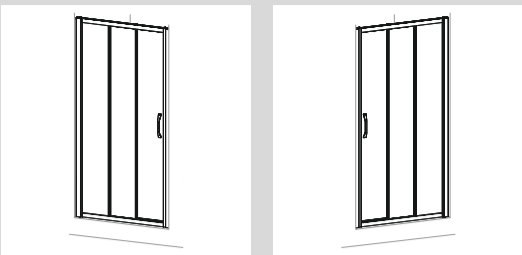

17

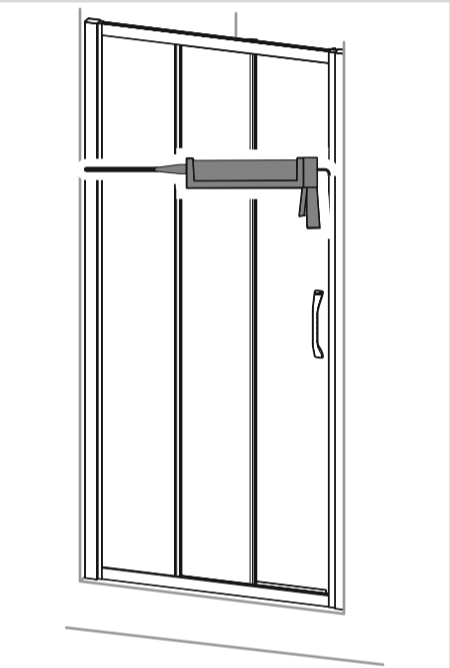
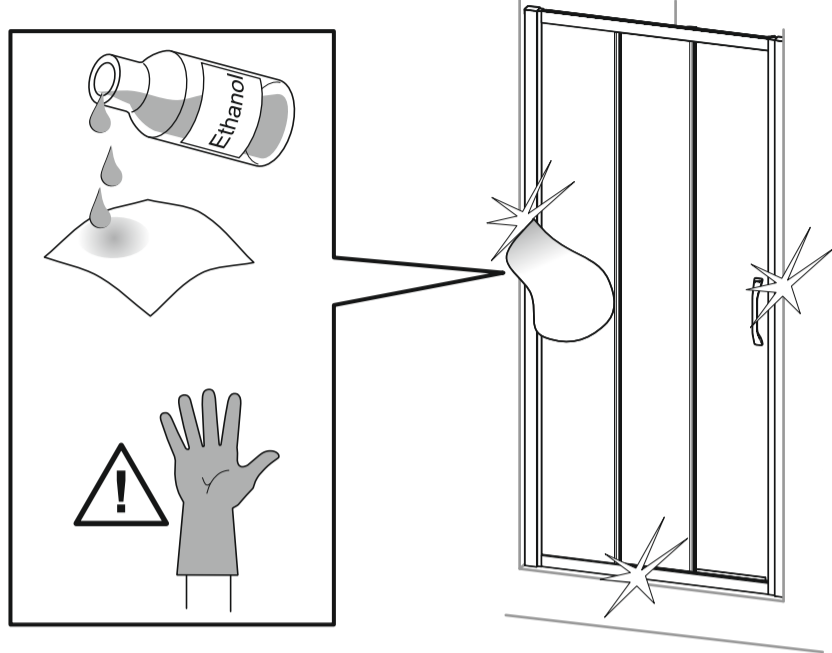

18

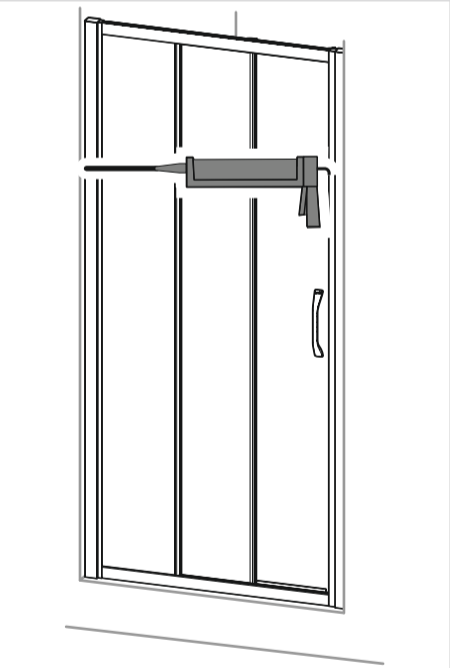
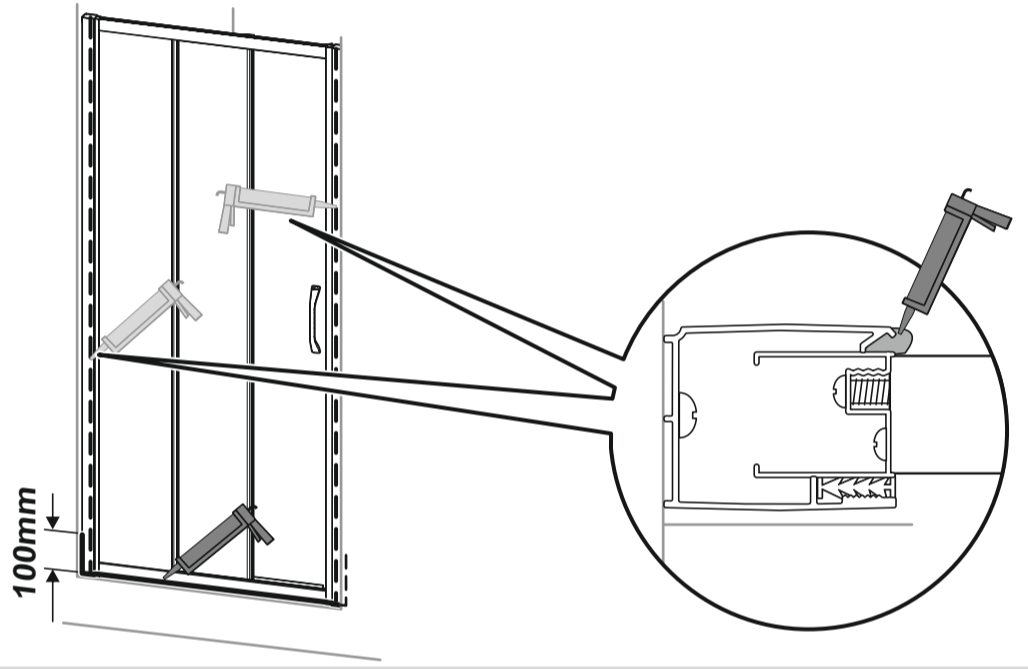

19

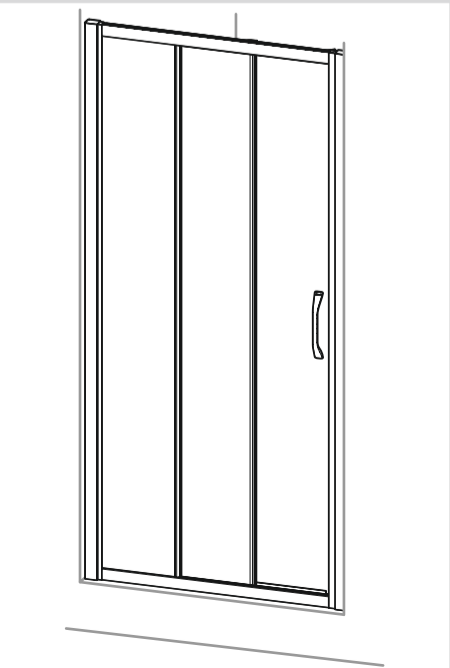
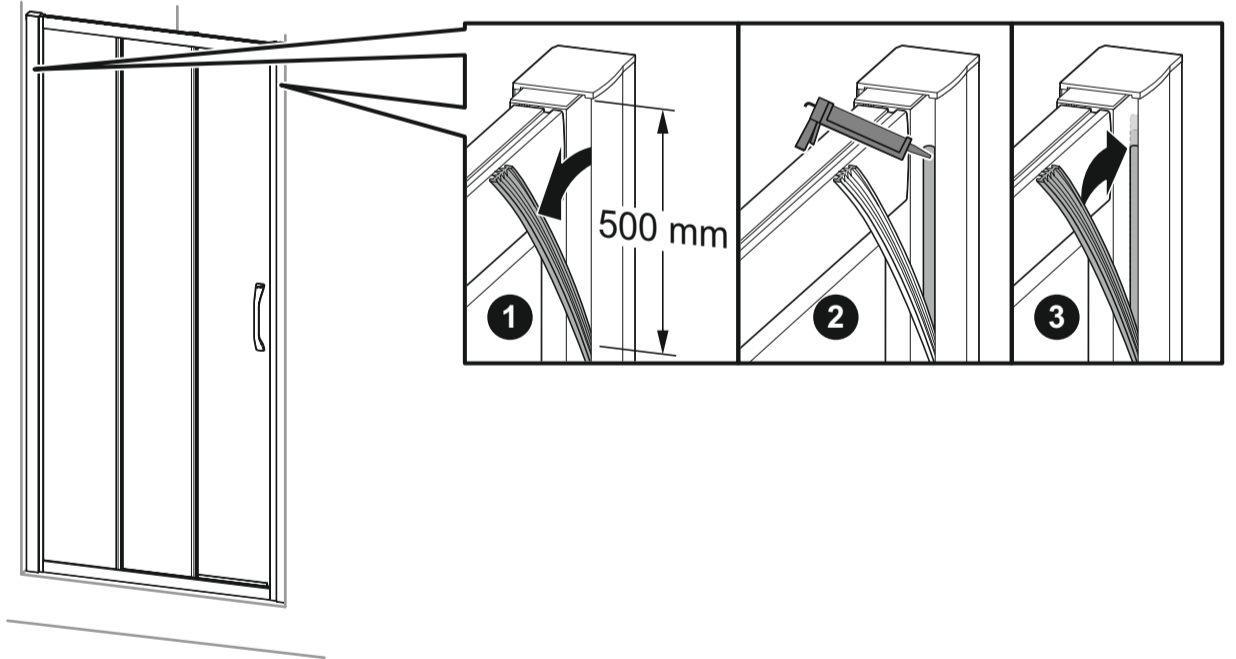

20

