

**1**

Montaggio  
Assembly

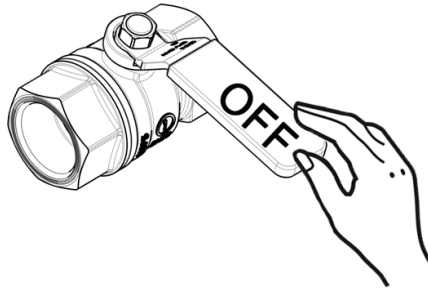

3 Bar	11,6 Lt/Min
-------	-------------

65°C MAX

1 5 bar

MIN - MAX

3 bar

OK

Detailed description: This section contains technical specifications and gauge readings. At the top left, a table with two columns and one row shows '3 Bar' and '11,6 Lt/Min'. To the right of the table is a thermometer icon with a scale and the text '65°C MAX'. Below these are two circular pressure gauges. The left gauge has a needle pointing to a value between 1 and 5, with '1' and '5' marked on the scale and 'bar' in the center. Below it is the text 'MIN - MAX'. The right gauge has a needle pointing to a value between 0 and 3, with '3' marked on the scale and 'bar' in the center. Below it is the text 'OK'. The entire section is framed by horizontal lines at the top and bottom.

**2 a**

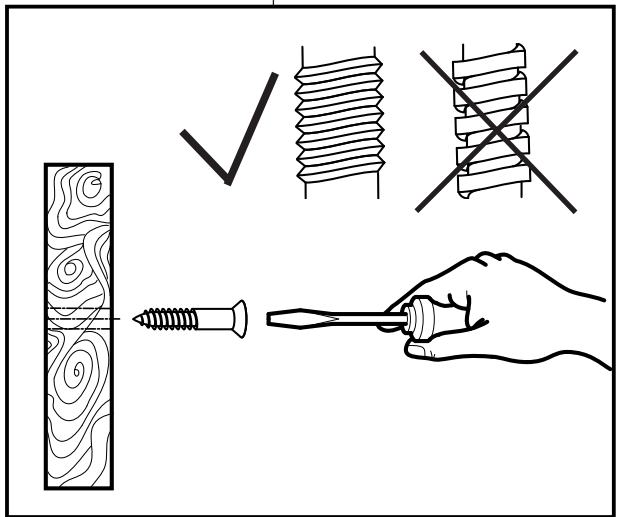
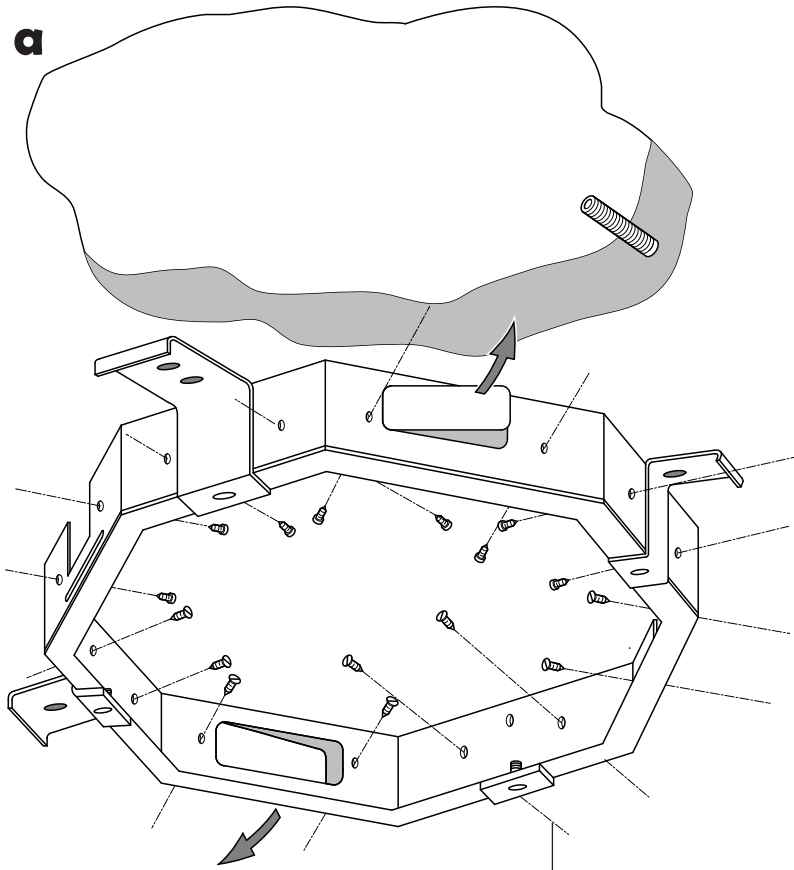

**b**

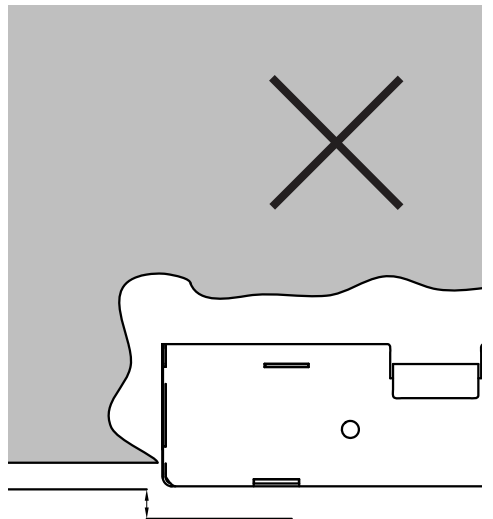
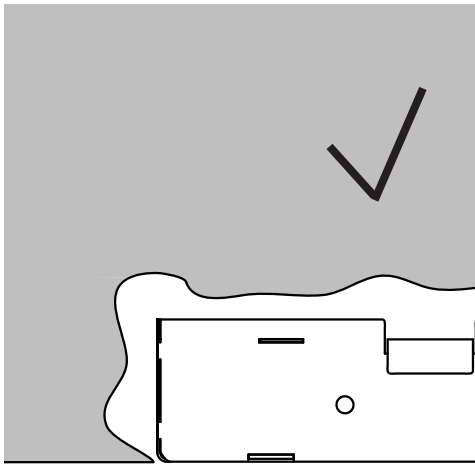
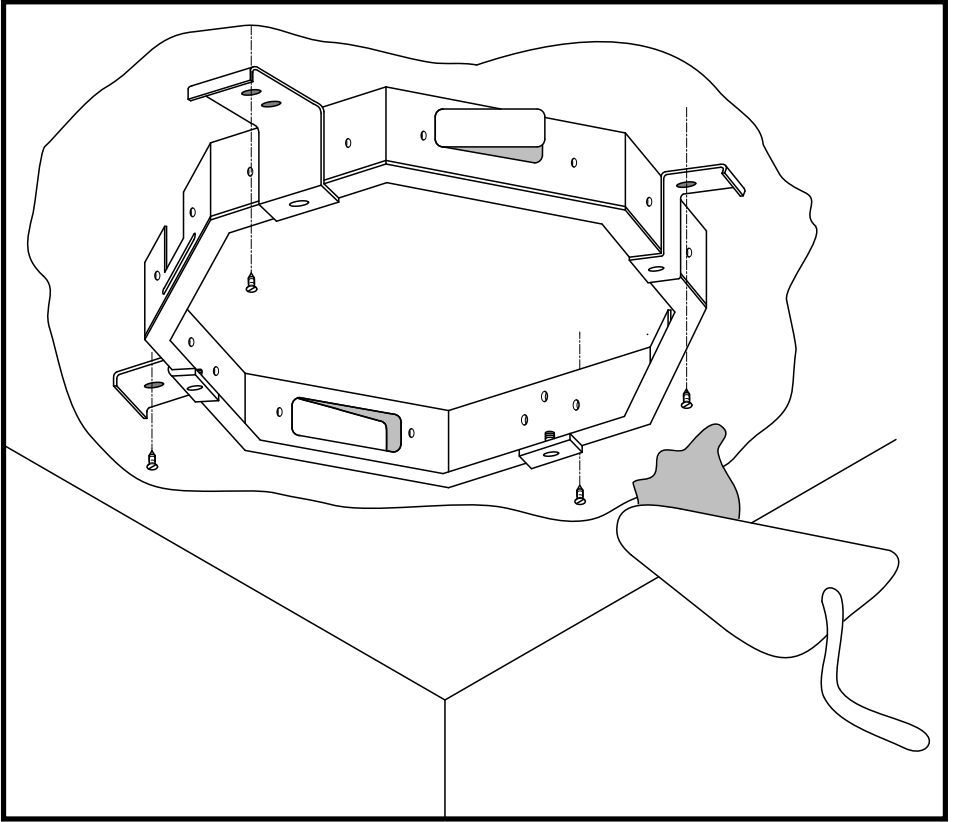

C

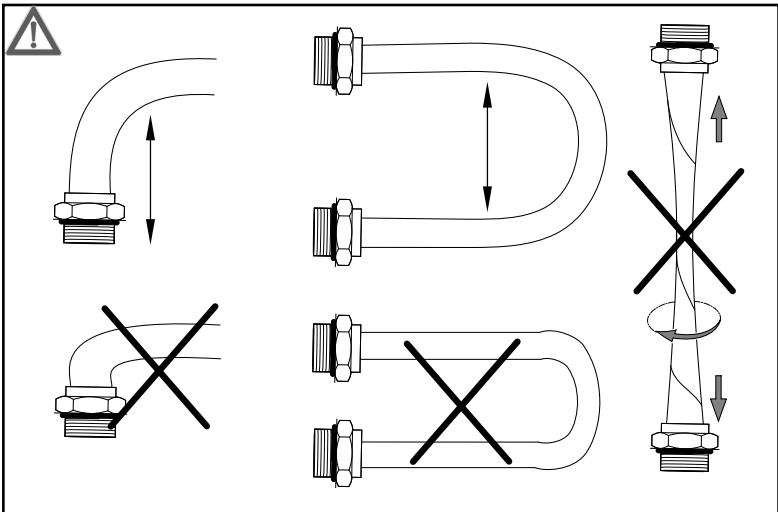
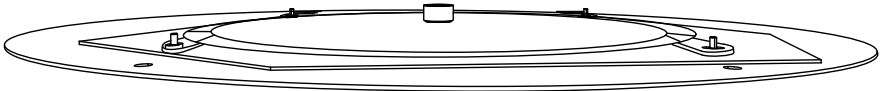
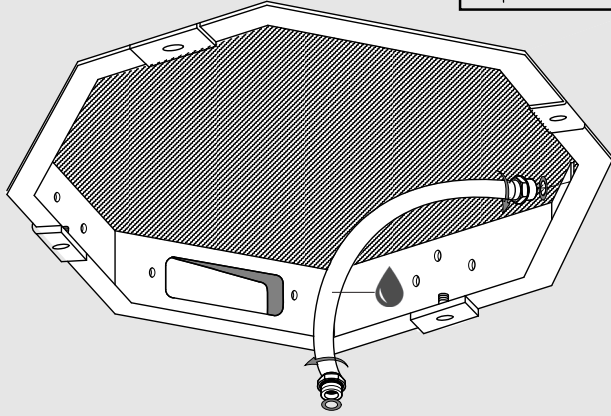
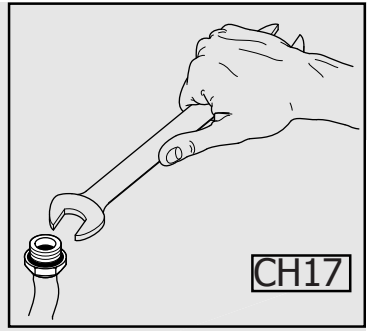

**d**

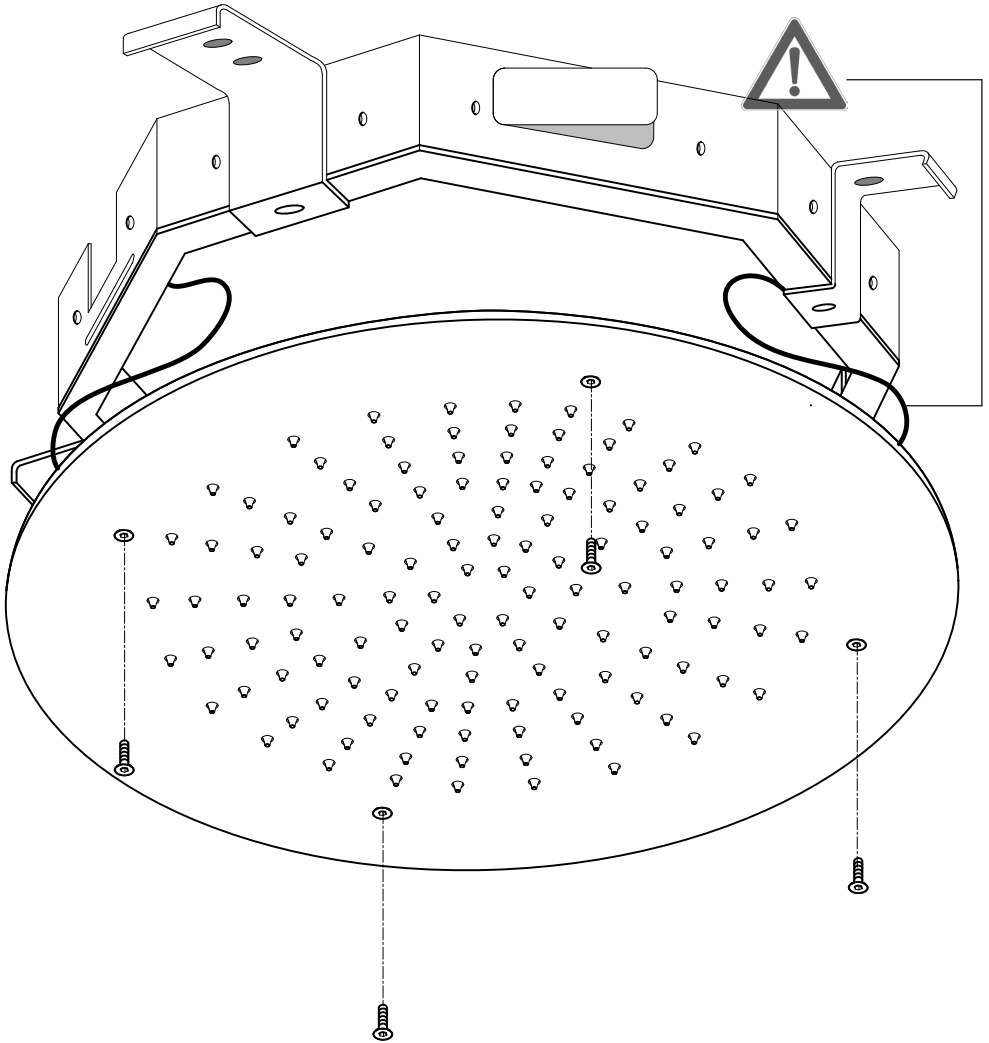
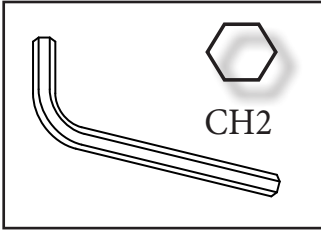

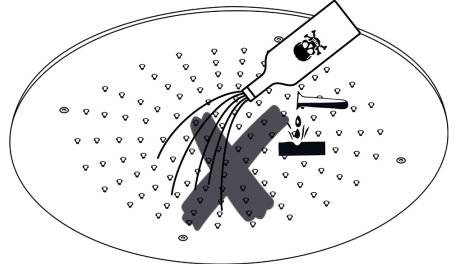
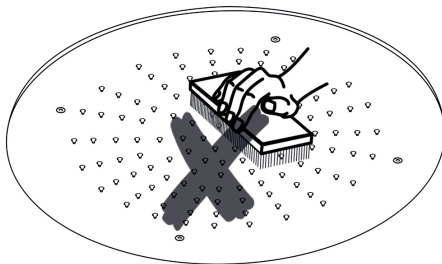
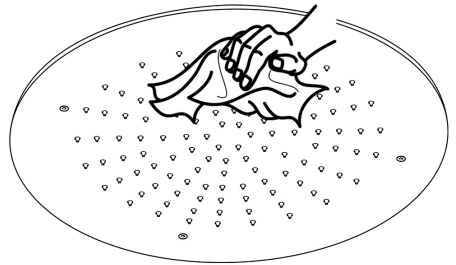
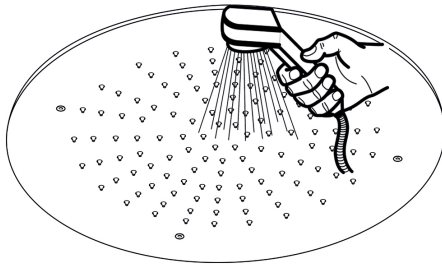
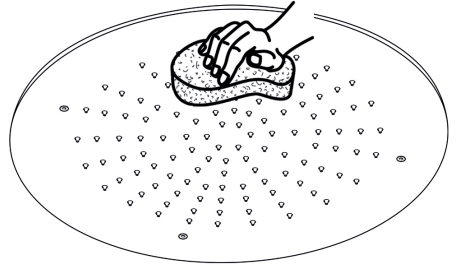
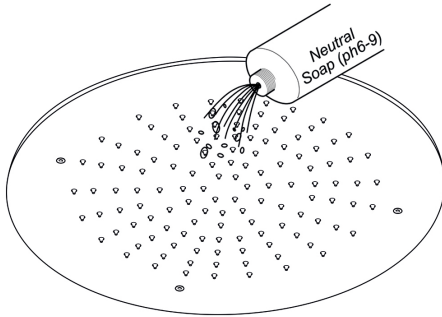

# P Pulizia Cleaning

