

INSTALLATION MANUAL

MONTAGEANLEITUNG
INSTRUCTIONS DE MONTAGE
ISTRUZIONI PER IL MONTAGGIO

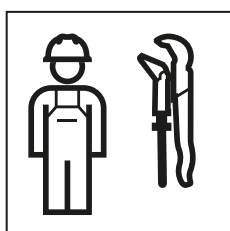



Geberit
Renova Plan

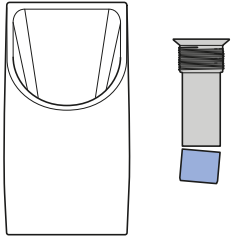

Geberit
Centaurus

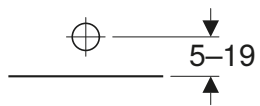
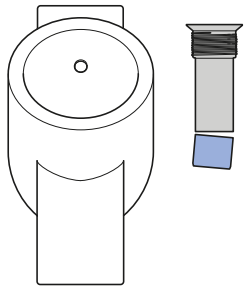

Geberit
Centaurus

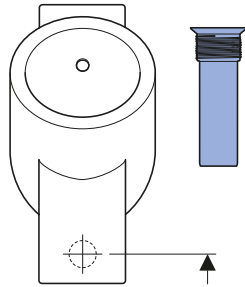

1

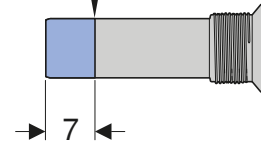
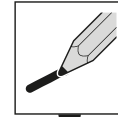
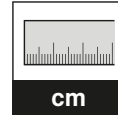

2

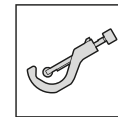

3

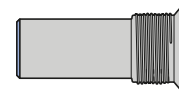
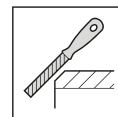

2

1

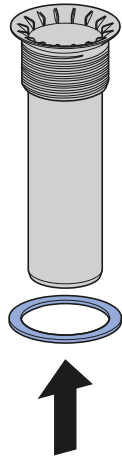

2

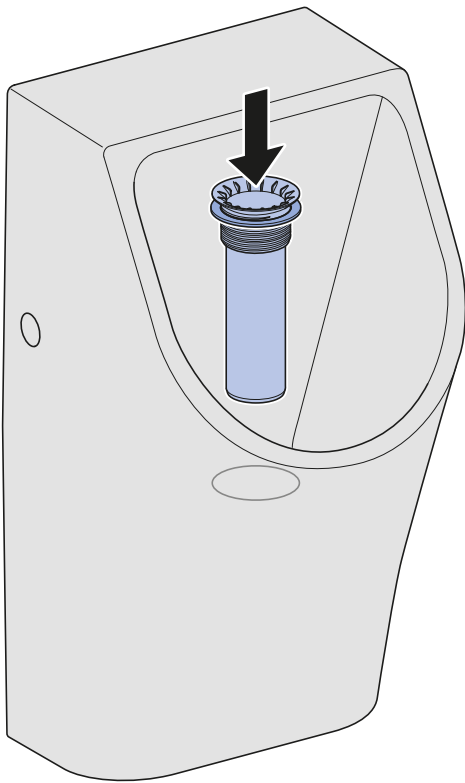

3

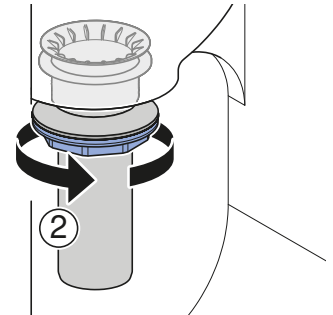
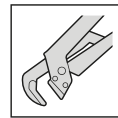
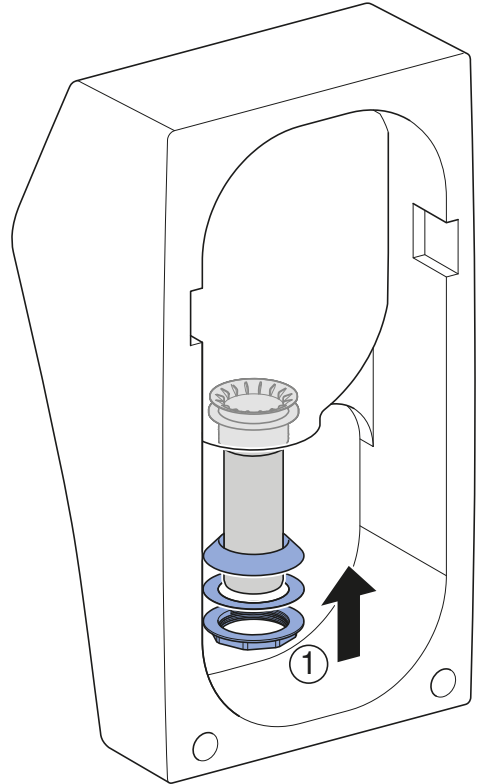

4

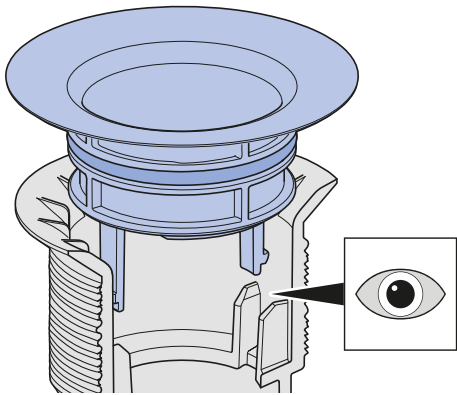
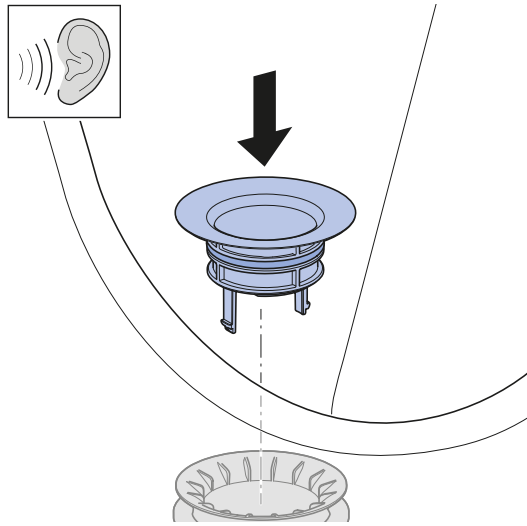

5

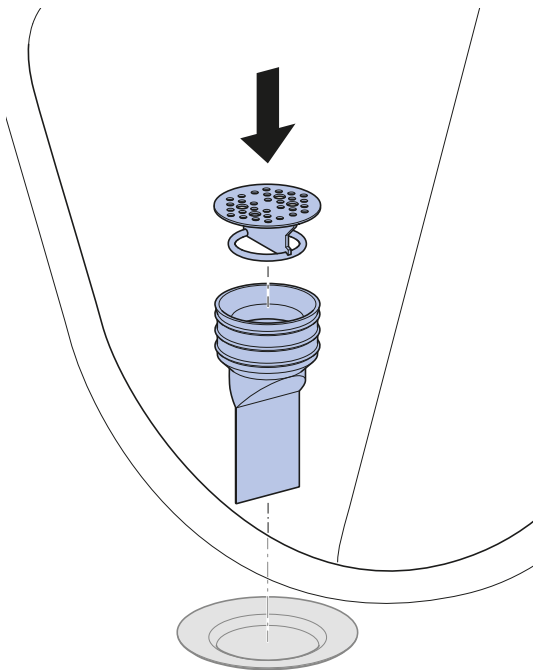

i

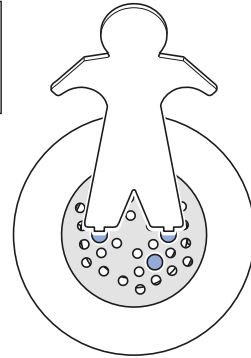
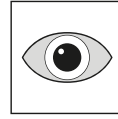

1

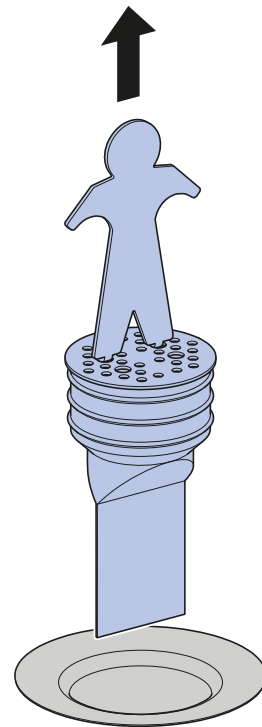
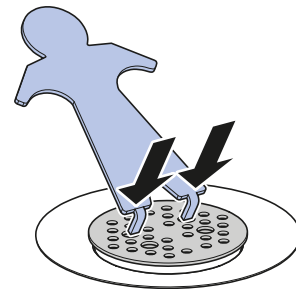

Geberit International AG
 Schachenstrasse 77, CH-8645 Jona
 documentation@geberit.com
 www.geberit.com

