

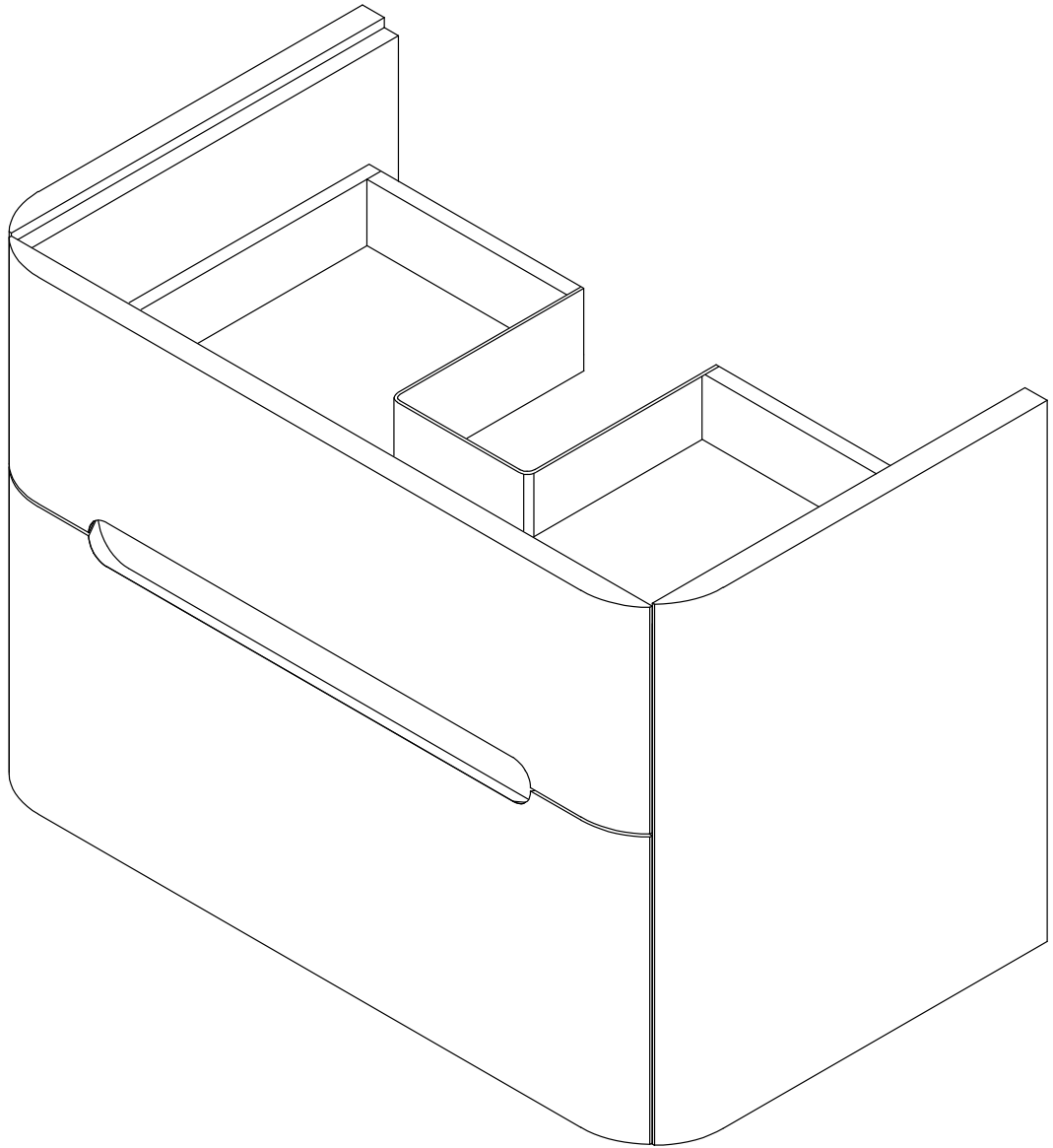

**SAT**

**SATFUSION260BE**  
**SATFUSION260W**



1

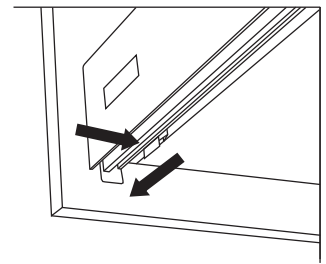
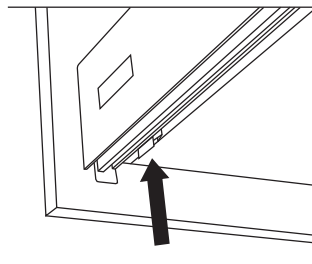
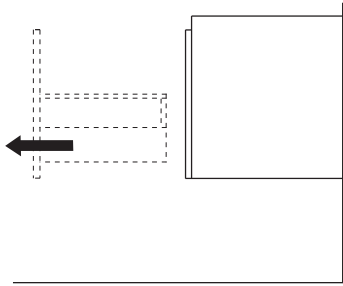

2

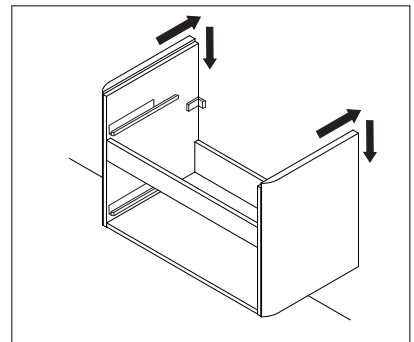
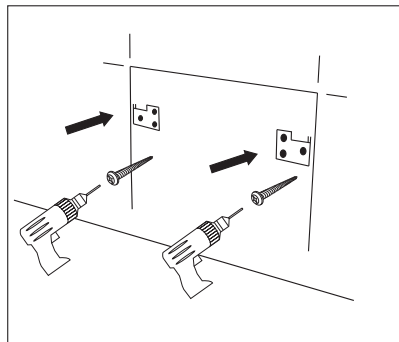
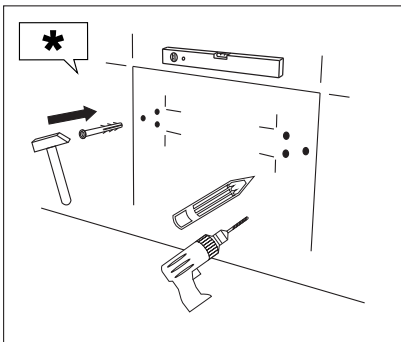
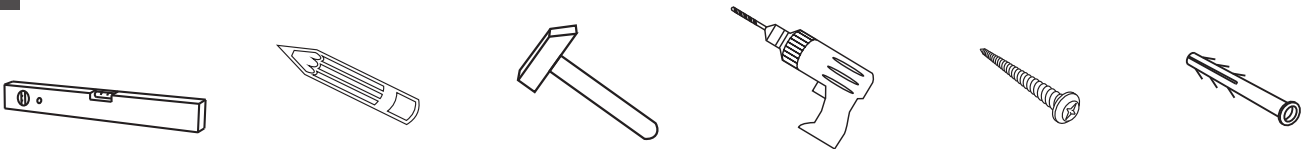

3

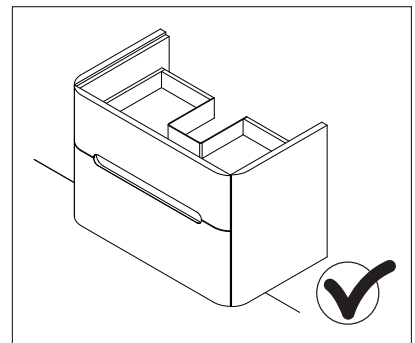
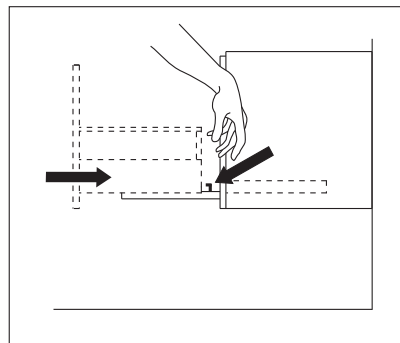
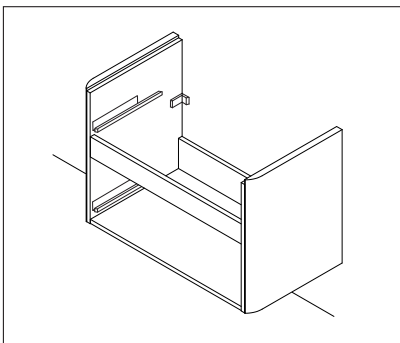

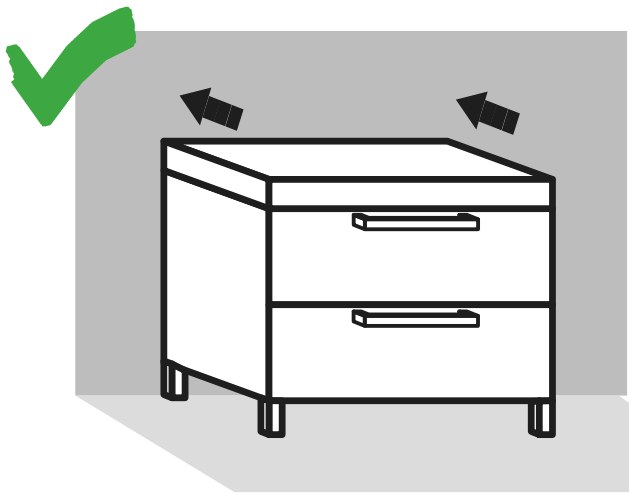
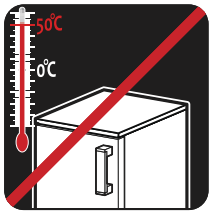
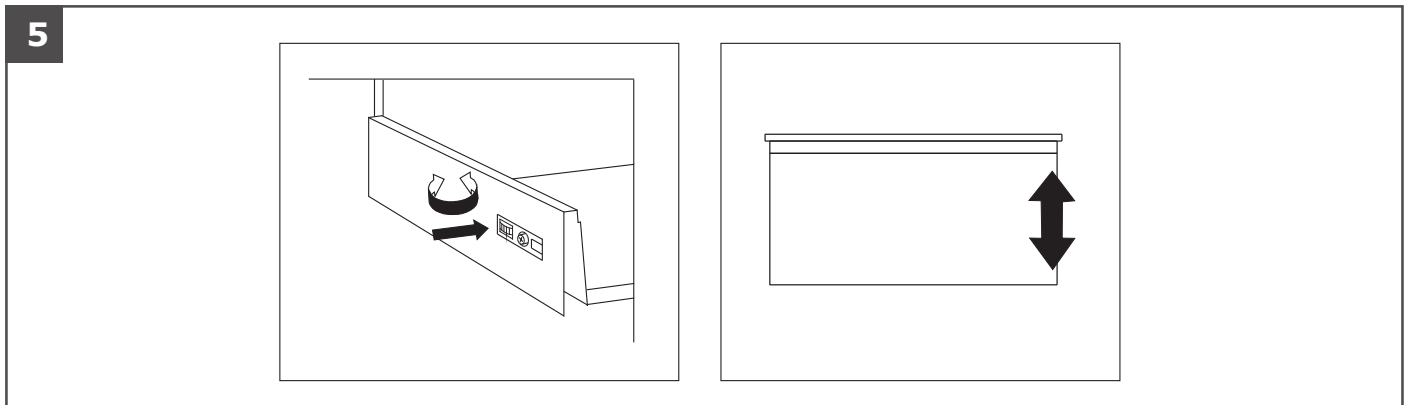
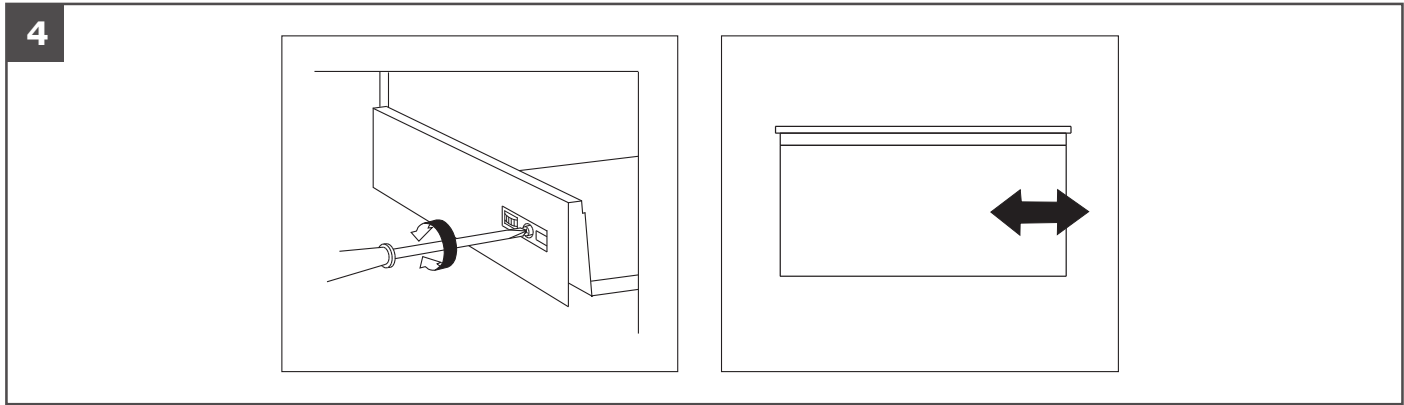

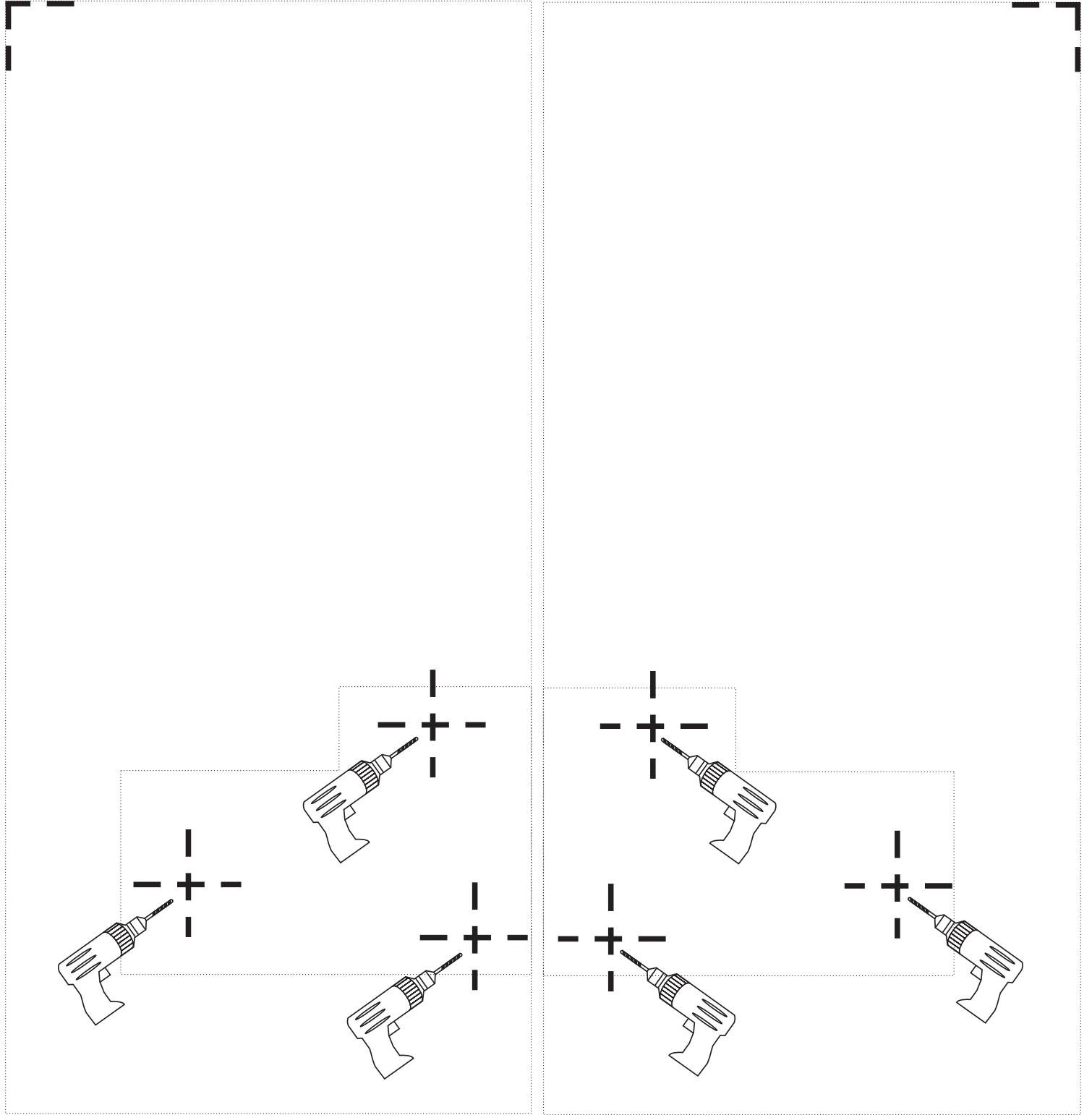
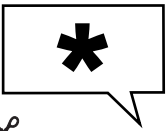

SAT® is registered trademark of



**Swiss  
Aqua  
Technologies**

**Swiss Aqua Technologies AG**  
Gewerbstrasse 9, 6330 Cham, Switzerland  
[www.swatec.ch](http://www.swatec.ch)  
Imported by SIKO KOUPELNY a.s.  
Made in Czech Republic