

155

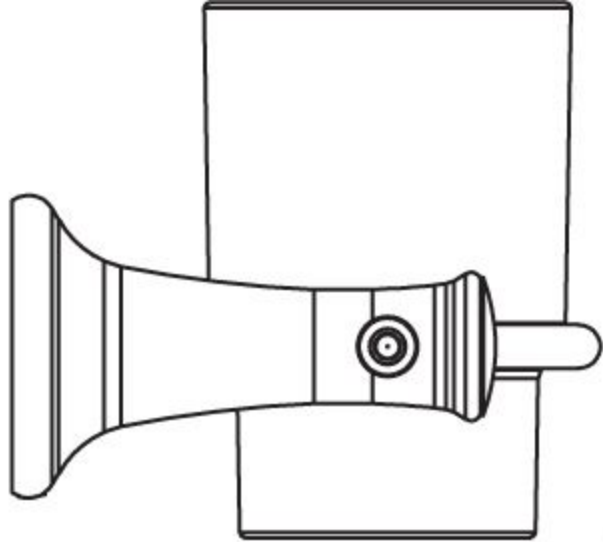

107,5

98