

MIAMI

This high gloss white acrylic bath has a lying side and a rounded footboard. The back shape is rounded in two directions, which created a comfortable lying shape. The bath is symmetrical, therefore to be placed in a right and left corner.



Riho acrylic bathtubs are made of high-quality acrylic, fully reinforced and all through white in colour. The acrylic baths are non-aging and UV resistant. The material is completely pore-free and smooth. Lime will adhere poorly so no bacteria remain. Therefore, the baths are easy to clean. The surface is pleasantly warm. Standard the bathtub does not include a legset and overflow/drain.

Article nr.	L x W x H (cm)	Volume* (ltr)	Weight (kg)	Water height (cm)	Option Rihopool**
B058001005	150 x 70 x 43	80	15	35	Air / Flow
B059001005	160 x 70 x 43	90	18	35	Air / Flow
B060001005	170 x 70 x 43	105	20	35	Air / Flow
B061001005	180 x 80 x 43	140	23	35	Air / Flow

* The contents of the baths are measured including the (average) volume of one person.

** Rihopool whirlpool systems already include a legset.

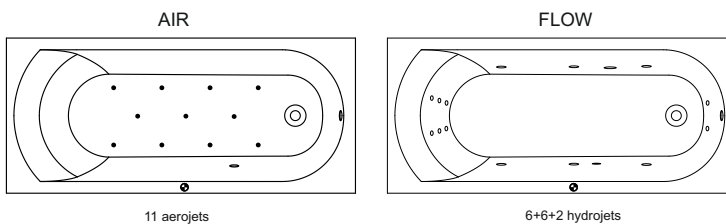

Additional to purchase

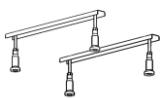

Pootset 01U
207093

Whirlpools already include a legset!



Mc Alpine
208867



Riho black
208711



Viega Multiplex
208873



Viega Multiplex Trio
208875

Optional to purchase



Headrest 19
207043



Headrest 19
207044



Headrest 13
207035



Headrest 13
207036



See next page

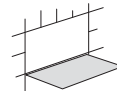

Inspection hatch
207019

Bath screen

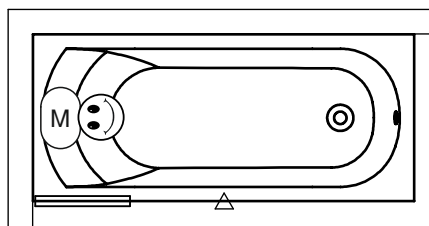

Scandic X107	Scandic X108	Scandic X109	Scandic X109V	Scandic X409	Scandic X500	Novik Z107	Novik Z500	Grid GB501	Lucid GD501
--------------	--------------	--------------	---------------	--------------	--------------	------------	------------	------------	-------------

Right type

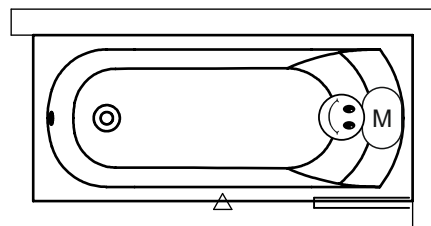

Left type



-  Motor Hydro or Aero
-  Control panel
-  Service hatch

BATH	Front panel	Side panel	Height (cm)
B058001005	209296	209279	57
B059001005	209298	209279	57
B060001005	209301	209279	57
B061001005	209307	209281	57

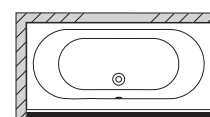
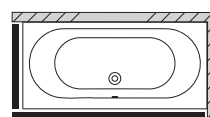
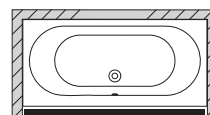

	A	B	C	D	E	F	G
B058001005	150	70	43	132	100	41,5	58
B059001005	160	70	43	142,5	110	41,5	58
B060001005	170	70	43	152,5	120	41,5	58
B061001005	180	80	43	162,5	130	41,5	68

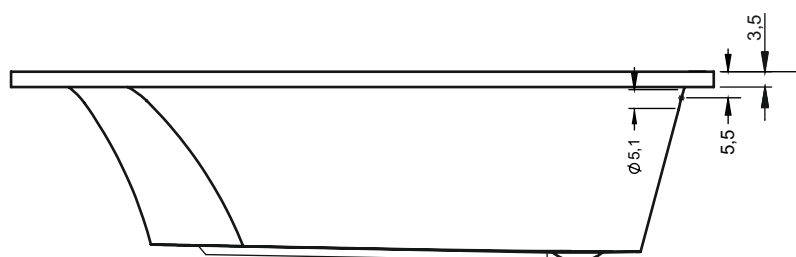
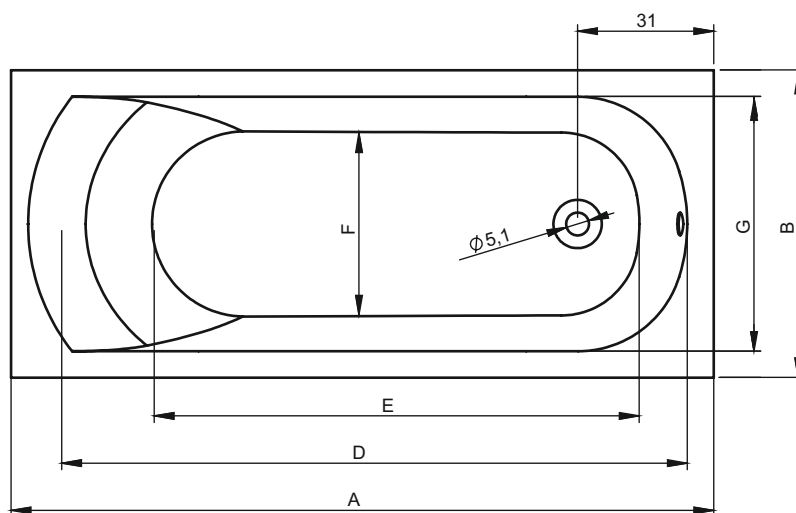

Data is subject to changes and/or errors