

---

# BLIX SLIM

---

## Katalog dílů

Platnost od 12/2021

**RAVAK**<sup>®</sup>

# BLSCP4 – 80

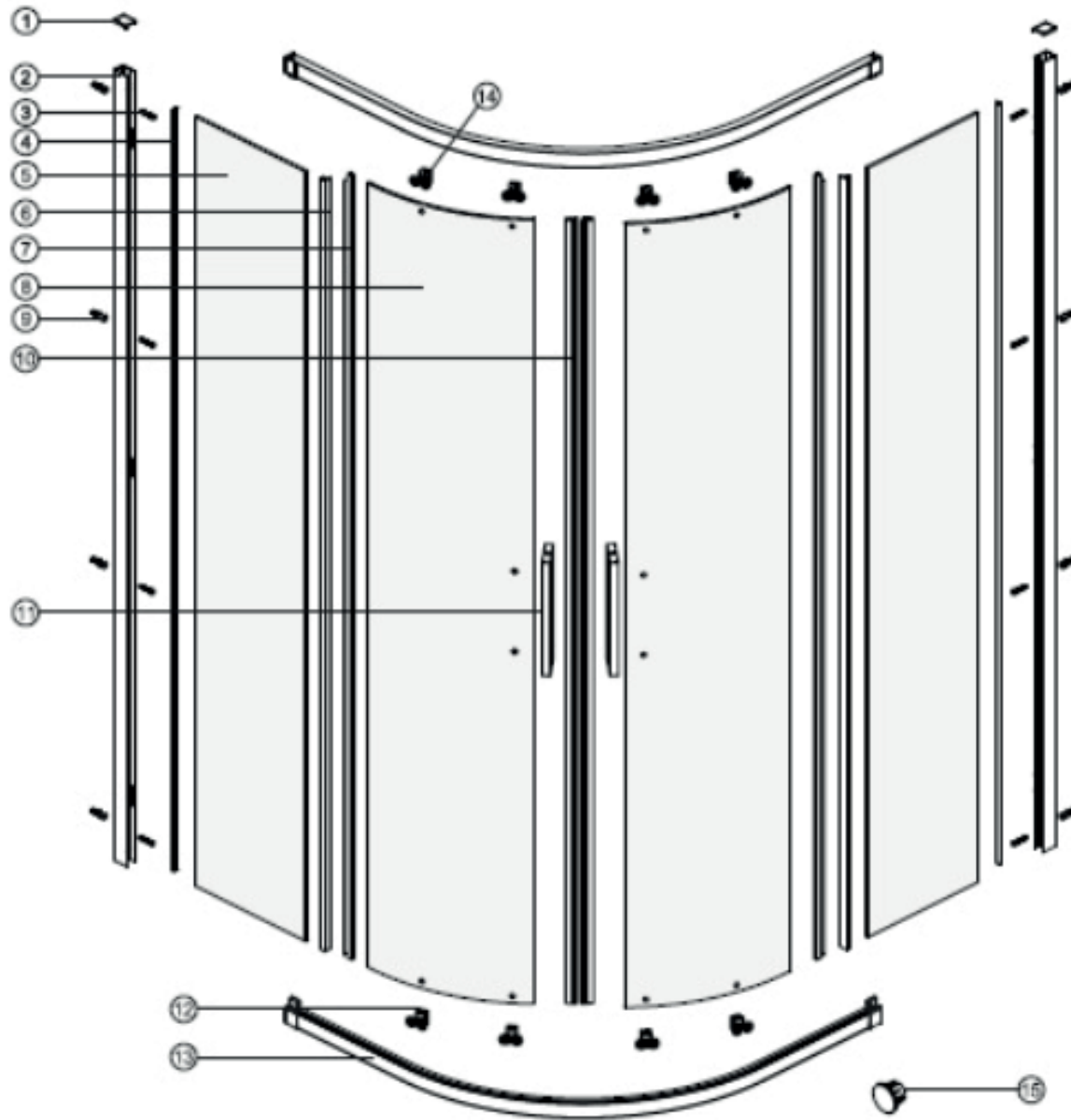



<b>BLSCP4 – 80 bright alu</b>				
<b>Číslo dílu</b>	<b>Název v MN</b>	<b>Počet</b>	<b>SIČ</b>	<b>Název</b>
1	Profile cap	2	XND0000148	Krytka profilu SJ1103
2	Wall jamb	2	XND0000064	Ustavovací profil, JG-AL0880-04 (1950 mm)
3	ST4x40	8	XND0000094	Vrut BLS 4x40
4	Wall profile cap	2	XND0000026	Profil JG-AL0882-04 (1879 mm)
5	Fixed panel	2	XND0000010	Sklo 6,0x1900x291 čiré BL-S22 Ravak-05
6	Fixed panel seal strip	2	XND0000042	Těsnící profil 304-06-20 (1877 mm)
7	Door panel seal strip	2	XND0000045	Těsnící profil 304-06-24 (1936 mm)
8	Moving door	2	XND0000008	Sklo dveře 6,0x1936x346 čiré BL-S22 Ravak-07
9	Wall anchor	8	XND0000061	Kotva AQ průměr 6
10	Magnet seal	2	XND0000021	Magnet 308GW-6-20, (1936 mm)
11	Handle	1	XND0000015	Madlo JG-AL0888-01
11	Handle	1	XND0000016	Madlo JG-AL0888-02
11	Handle	1	XND0000017	Záslepka madla SJ1050, sada 4ks
11	Handle	2	XND0000018	Šroub madla 8x6x4, sada 2ks
12	Bottom Wheels	4	XND0000002	Spodní kolečko dveří HL047
13	Rail	2	XND0000040	Vodící profil, JG-AL0895-14 (1341 mm)
14	Top wheels	4	XND0000055	Horní kolečko dveří HL046
15	Handle cap	4	XND0000014	Krytka madla SJ744

## **BLSCP4 – 80 bright alu**

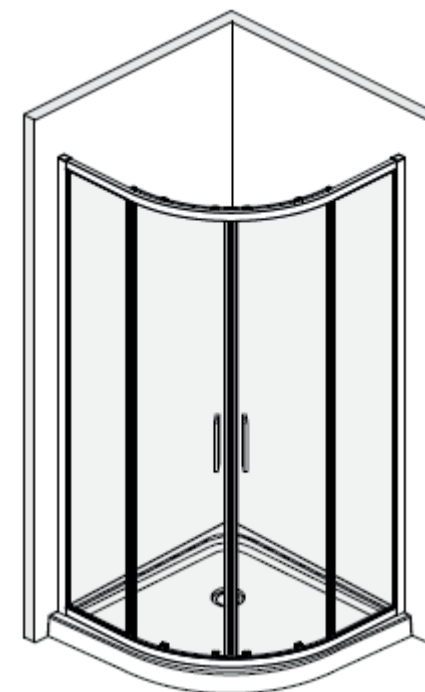

<b>BLSCP4 – 80 black</b>				
<b>Číslo dílu</b>	<b>Název v MN</b>	<b>Počet</b>	<b>SIČ</b>	<b>Název</b>
1	Profile cap	2	XND0000120	Krytka profilu SJ1103 - Black
2	Wall jamb	2	XND0000139	Ustavovací profil, JG-AL0880-04 (1950 mm) - Black
3	ST4x40	8	XND0000094	Vrut BLS 4x40
4	Wall profile cap	2	XND0000121	Profil JG-AL0882-04 (1879 mm) - Black
5	Fixed panel	2	XND0000010	Sklo 6,0x1900x291 čiré BL-S22 Ravak-05
6	Fixed panel seal strip	2	XND0000132	Těsnící profil 304-06-20 (1877 mm) - Black
7	Door panel seal strip	2	XND0000135	Těsnící profil 304-06-24 (1936 mm) - Black
8	Moving door	2	XND0000008	Sklo dveře 6,0x1936x346 čiré BL-S22 Ravak-07
9	Wall anchor	8	XND0000061	Kotva AQ průměr 6
10	Magnet seal	2	XND0000117	Magnet 308GW-6-20, (1936 mm) - Black
11	Handle	1	XND0000113	Madlo JG-AL0888-01 - Black
11	Handle	1	XND0000114	Madlo JG-AL0888-02 - Black
11	Handle	1	XND0000115	Záslepka madla SJ1050, sada 4ks - Black
11	Handle	2	XND0000018	Šroub madla 8x6x4, sada 2ks
12	Bottom Wheels	4	XND0000109	Spodní kolečko dveří HL047 - Black
13	Rail	2	XND0000130	Vodící profil, JG-AL0895-14 (1341 mm) - Black
14	Top wheels	4	XND0000136	Horní kolečko dveří HL046 - Black
15	Handle cap	4	XND0000112	Krytka madla SJ744 - Black

## **BLSCP4 – 80 black**

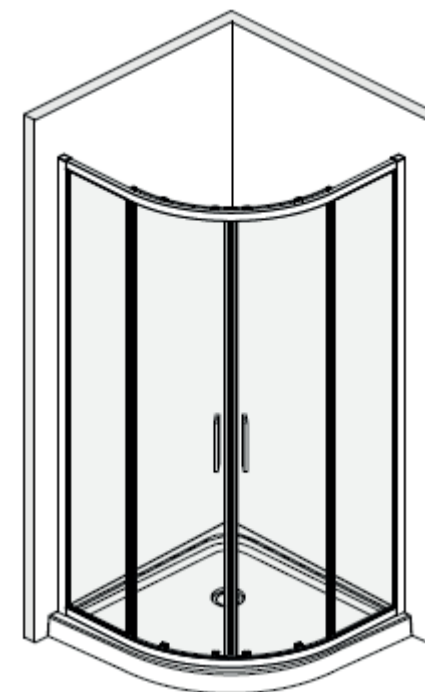

# BLSCP4 – 90

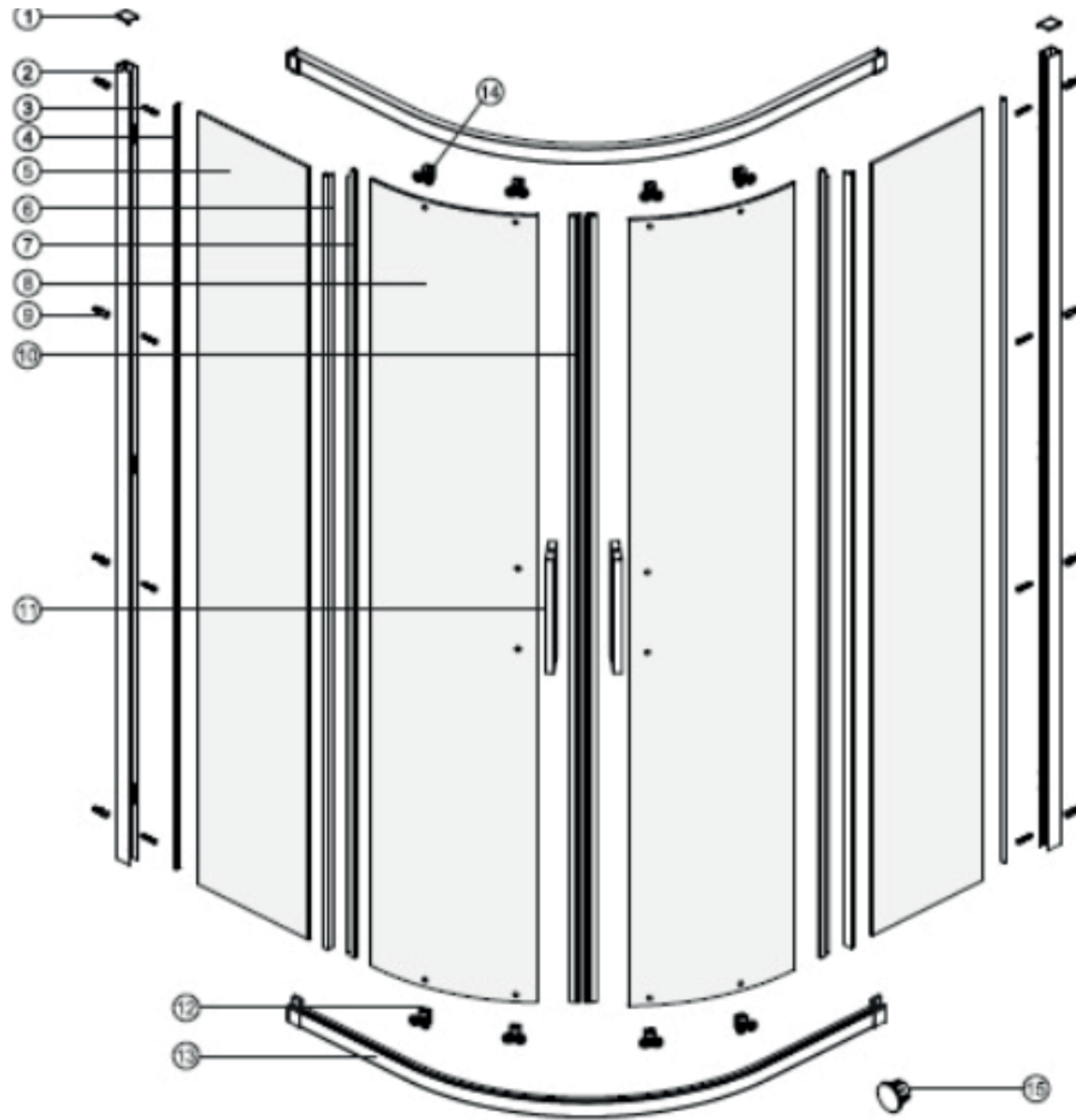



<b>BLSCP4 – 90 bright alu</b>				
<b>Číslo dílu</b>	<b>Název v MN</b>	<b>Počet</b>	<b>SIČ</b>	<b>Název</b>
1	Profile cap	2	XND0000148	Krytka profilu SJ1103
2	Wall jamb	2	XND0000064	Ustavovací profil, JG-AL0880-04 (1950 mm)
3	ST4x40	8	XND0000094	Vrut BLS 4x40
4	Wall profile cap	2	XND0000026	Profil JG-AL0882-04 (1879 mm)
5	Fixed panel	2	XND0000010	Sklo 6,0x1900x391 čiré BL-S22 Ravak-06
6	Fixed panel seal strip	2	XND0000042	Těsnící profil 304-06-20 (1877 mm)
7	Door panel seal strip	2	XND0000045	Těsnící profil 304-06-24 (1936 mm)
8	Moving door	2	XND0000008	Sklo dveře 6,0x1936x346 čiré BL-S22 Ravak-07
9	Wall anchor	8	XND0000061	Kotva AQ průměr 6
10	Magnet seal	2	XND0000021	Magnet 308GW-6-20, (1936 mm)
11	Handle	1	XND0000015	Madlo JG-AL0888-01
11	Handle	1	XND0000016	Madlo JG-AL0888-02
11	Handle	1	XND0000017	Záslepka madla SJ1050, sada 4ks
11	Handle	2	XND0000018	Šroub madla 8x6x4, sada 2ks
12	Bottom Wheels	4	XND0000002	Spodní kolečko dveří HL047
13	Rail	2	XND0000040	Vodící profil, JG-AL0895-14 (1341 mm)
14	Top wheels	4	XND0000055	Horní kolečko dveří HL046
15	Handle cap	4	XND0000014	Krytka madla SJ744

## **BLSCP4 – 90 bright alu**

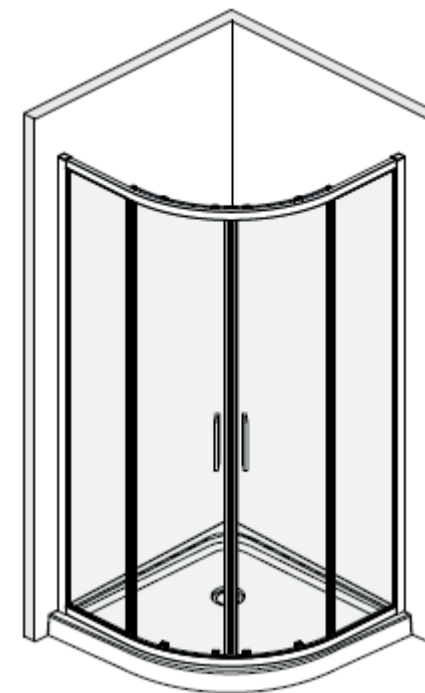



<b>BLSCP4 – 90 black</b>				
<b>Číslo dílu</b>	<b>Název v MN</b>	<b>Počet</b>	<b>SIČ</b>	<b>Název</b>
1	Profile cap	2	XND0000120	Krytka profilu SJ1103 - Black
2	Wall jamb	2	XND0000139	Ustavovací profil, JG-AL0880-04 (1950 mm) - Black
3	ST4x40	8	XND0000094	Vrut BLS 4x40
4	Wall profile cap	2	XND0000121	Profil JG-AL0882-04 (1879 mm) - Black
5	Fixed panel	2	XND0000011	Sklo 6,0x1900x391 čiré BL-S22 Ravak-06
6	Fixed panel seal strip	2	XND0000132	Těsnící profil 304-06-20 (1877 mm) - Black
7	Door panel seal strip	2	XND0000135	Těsnící profil 304-06-24 (1936 mm) - Black
8	Moving door	2	XND0000008	Sklo dveře 6,0x1936x346 čiré BL-S22 Ravak-07
9	Wall anchor	8	XND0000061	Kotva AQ průměr 6
10	Magnet seal	2	XND0000117	Magnet 308GW-6-20, (1936 mm) - Black
11	Handle	1	XND0000113	Madlo JG-AL0888-01 - Black
11	Handle	1	XND0000114	Madlo JG-AL0888-02 - Black
11	Handle	1	XND0000115	Záslepka madla SJ1050, sada 4ks - Black
11	Handle	2	XND0000018	Šroub madla 8x6x4, sada 2ks
12	Bottom Wheels	4	XND0000109	Spodní kolečko dveří HL047 - Black
13	Rail	2	XND0000130	Vodící profil, JG-AL0895-14 (1341 mm) - Black
14	Top wheels	4	XND0000136	Horní kolečko dveří HL046 - Black
15	Handle cap	4	XND0000112	Krytka madla SJ744 - Black

## **BLSCP4 – 90 black**

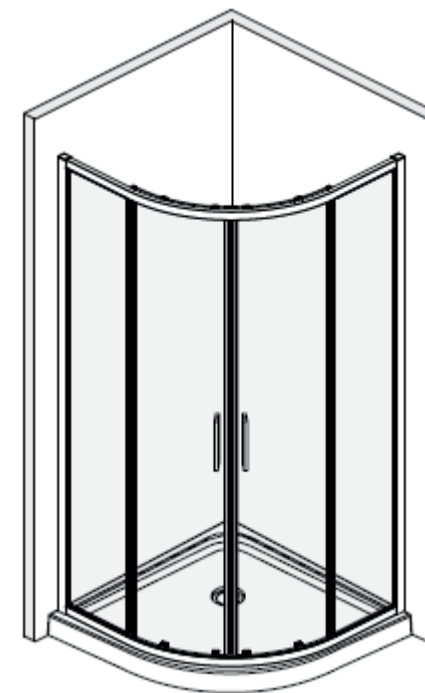

# BLSRV2 – 80

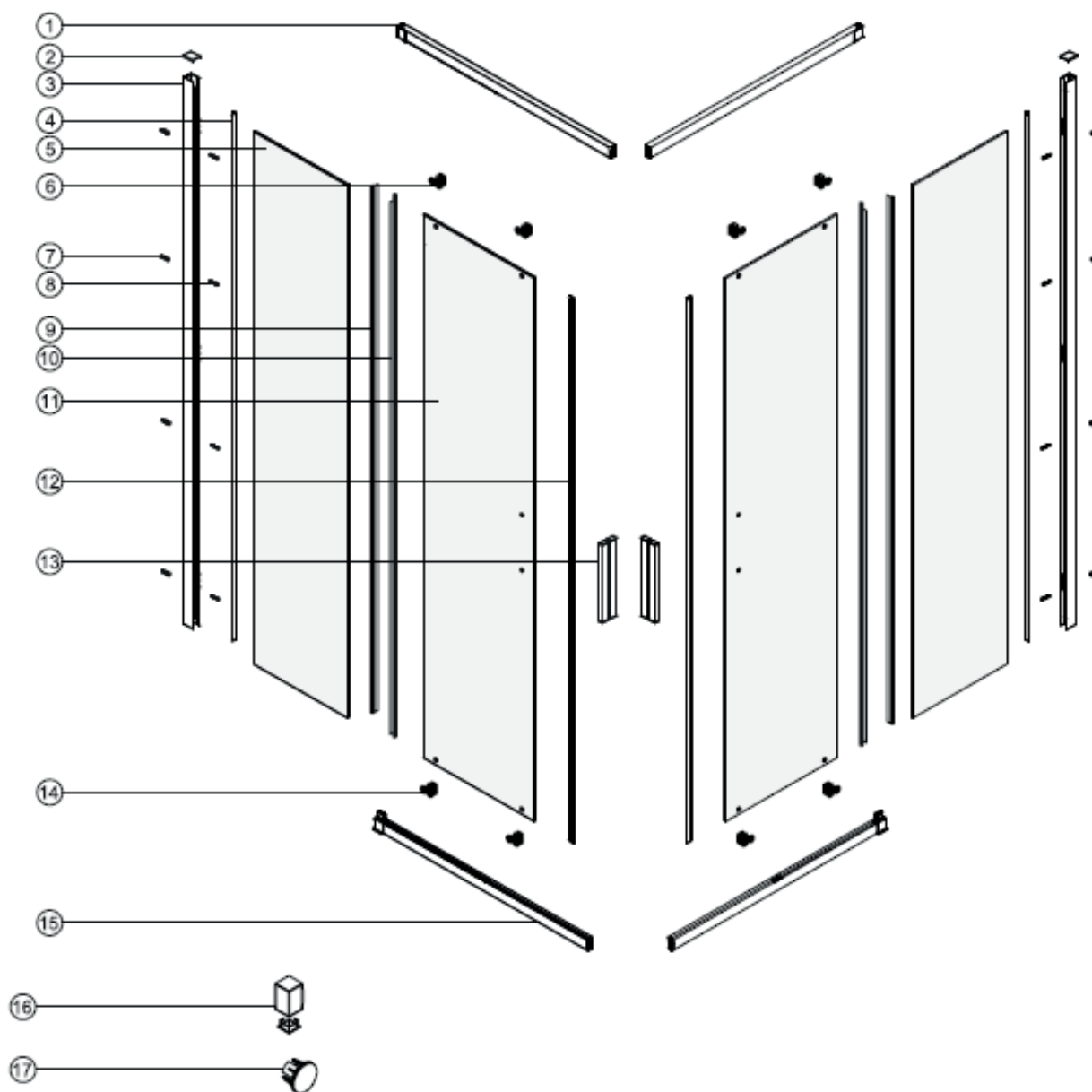



<b>BLSRV2 – 80 bright alu</b>				
<b>Číslo dílu</b>	<b>Název v MN</b>	<b>Počet</b>	<b>SIČ</b>	<b>Název</b>
1	Top track	2	XND0000032	Vodící profil, JG-AL0879-03L (751,5 mm)
2	Channel cap extrusion	2	XND0000148	Krytka profilu SJ1103
3	Wall track	2	XND0000064	Ustavovací profil, JG-AL0880-04 (1950 mm)
4	Channel cap	2	XND0000026	Profil JG-AL0882-04 (1879 mm)
5	Fixed panel	2	XND0000081	Sklo 6,0x1900x338čiré BL-S22 Ravak-02
6	Top wheels	4	XND0000055	Horní kolečko dveří HL046
7	Wall anchor	8	XND0000061	Kotva AQ průměr 6
8	ST4x40 Screw	8	XND0000094	Vrut BLS 4x40
9	Fixed panel seal strip	2	XND0000043	Těsnící profil 304-06-24 (1877 mm)
10	Door panel seal strip	2	XND0000044	Těsnící profil 304-06-24 (1935 mm)
11	Door panel	2	XND0000080	Sklo 6,0x1935x400čiré BL-S22 Ravak-01
12	Magnet seal	2	XND0000020	Magnet 308GA-6, (1935 mm)
13	Handle	1	XND0000015	Madlo JG-AL0888-01
13	Handle	1	XND0000016	Madlo JG-AL0888-02
13	Handle	1	XND0000017	Záslepka madla SJ1050, sada 4ks
13	Handle	2	XND0000018	Šroub madla 8x6x4, sada 2ks
14	Bottom wheels	2	XND0000002	Spodní kolečko dveří HL047
15	Bottom track	2	XND0000036	Vodící profil, JG-AL0879-03R (751,5 mm)
16	Track connector	2	XND0000006	Rohová spojka ZJ552
17	Handle cap	4	XND0000014	Krytka madla SJ744

## **BLSRV2 – 80 bright alu**



<b>BLSRV2 – 80 black</b>				
<b>Číslo dílu</b>	<b>Název v MN</b>	<b>Počet</b>	<b>SIČ</b>	<b>Název</b>
1	Top track	2	XND0000122	Vodící profil, JG-AL0879-03L (751,5 mm) - Black
2	Channel cap extrusion	2	XND0000120	Krytka profilu SJ1103 - Black
3	Wall track	2	XND0000139	Ustavovací profil, JG-AL0880-04 (1950 mm) - Black
4	Channel cap	2	XND0000121	Profil JG-AL0882-04 (1879 mm) - Black
5	Fixed panel	2	XND0000081	Sklo 6,0x1900x338čiré BL-S22 Ravak-02
6	Top wheels	4	XND0000136	Horní kolečko dveří HL046 - Black
7	Wall anchor	8	XND0000061	Kotva AQ průměr 6
8	ST4x40 Screw	8	XND0000094	Vrut BLS 4x40
9	Fixed panel seal strip	2	XND0000133	Těsnící profil 304-06-24 (1877 mm) - Black
10	Door panel seal strip	2	XND0000134	Těsnící profil 304-06-24 (1935 mm) - Black
11	Door panel	2	XND0000080	Sklo 6,0x1935x400čiré BL-S22 Ravak-01
12	Magnet seal	2	XND0000116	Magnet 308GA-6, (1935 mm) - Black
13	Handle	1	XND0000113	Madlo JG-AL0888-01 - Black
13	Handle	1	XND0000114	Madlo JG-AL0888-02 - Black
13	Handle	1	XND0000115	Záslepka madla SJ1050, sada 4ks - Black
13	Handle	2	XND0000018	Šroub madla 8x6x4, sada 2ks
14	Bottom wheels	2	XND0000109	Spodní kolečko dveří HL047 - Black
15	Bottom track	2	XND0000126	Vodící profil, JG-AL0879-03R (751,5 mm) - Black
16	Track connector	2	XND0000110	Rohová spojka ZJ552 - Black
17	Handle cap	4	XND0000112	Krytka madla SJ744 - Black

## **BLSRV2 – 80 black**



# BLSRV2 – 90

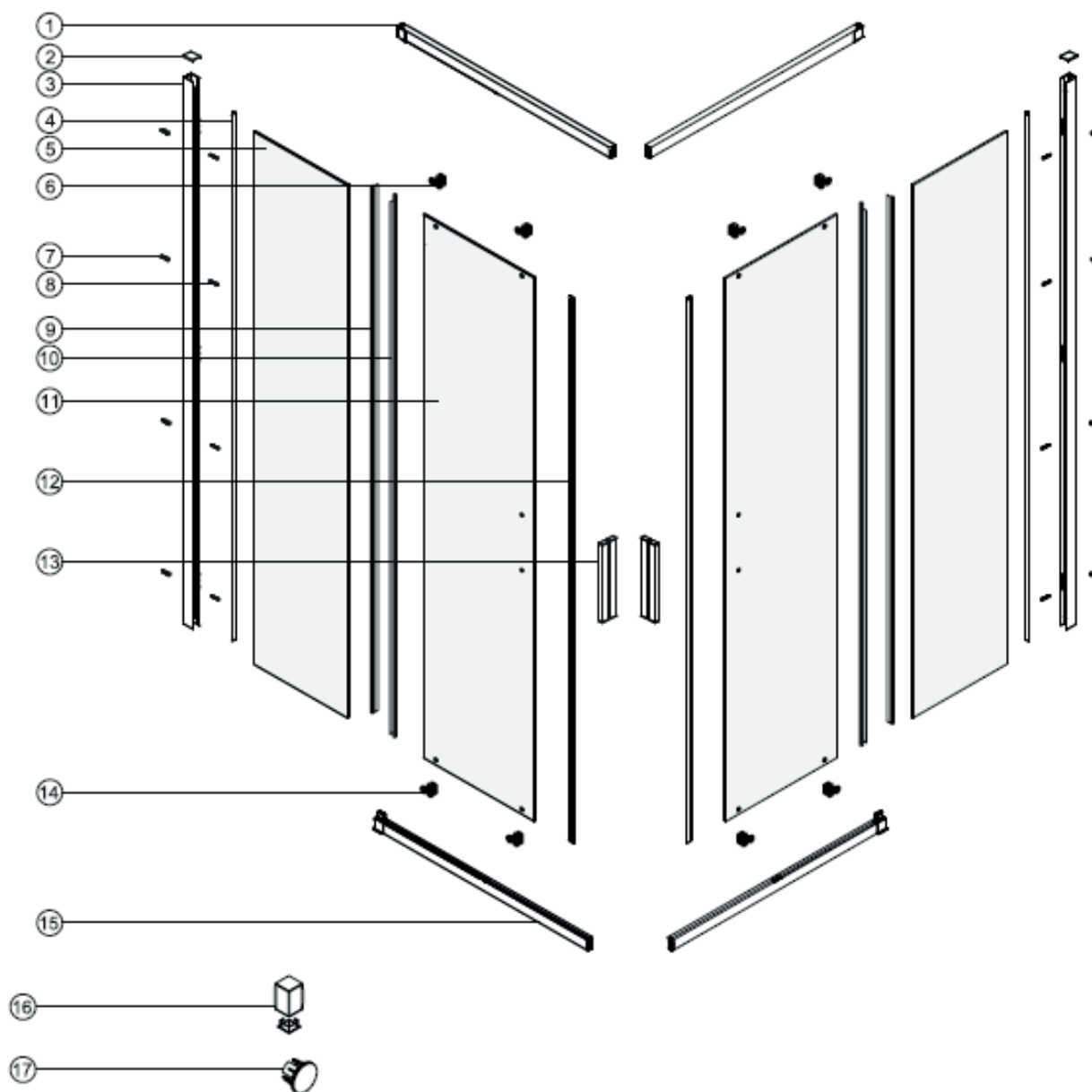



<b>BLSRV2 – 90 bright alu</b>				
<b>Číslo dílu</b>	<b>Název v MN</b>	<b>Počet</b>	<b>SIČ</b>	<b>Název</b>
1	Top track	2	XND0000033	Vodící profil, JG-AL0879-04L (851,5 mm)
2	Channel cap extrusion	2	XND0000148	Krytka profilu SJ1103
3	Wall track	2	XND0000064	Ustavovací profil, JG-AL0880-04 (1950 mm)
4	Channel cap	2	XND0000026	Profil JG-AL0882-04 (1879 mm)
5	Fixed panel	2	XND0000096	Sklo 6,0x1900x338čiré BL-S22 Ravak-04
6	Top wheels	4	XND0000055	Horní kolečko dveří HL046
7	Wall anchor	8	XND0000061	Kotva AQ průměr 6
8	ST4x40 Screw	8	XND0000094	Vrut BLS 4x40
9	Fixed panel seal strip	2	XND0000043	Těsnící profil 304-06-24 (1877 mm)
10	Door panel seal strip	2	XND0000044	Těsnící profil 304-06-24 (1935 mm)
11	Door panel	2	XND0000082	Sklo 6,0x1935x450čiré BL-S22 Ravak-03
12	Magnet seal	2	XND0000020	Magnet 308GA-6, (1935 mm)
13	Handle	1	XND0000015	Madlo JG-AL0888-01
13	Handle	1	XND0000016	Madlo JG-AL0888-02
13	Handle	1	XND0000017	Záslepka madla SJ1050, sada 4ks
13	Handle	2	XND0000018	Šroub madla 8x6x4, sada 2ks
14	Bottom wheels	2	XND0000002	Spodní kolečko dveří HL047
15	Bottom track	2	XND0000037	Vodící profil, JG-AL0879-04R (851,5 mm)
16	Track connector	2	XND0000006	Rohová spojka ZJ552
17	Handle cap	4	XND0000014	Krytka madla SJ744

## **BLSRV2 – 90 bright alu**





<b>BLSRV2 – 90 black</b>				
<b>Číslo dílu</b>	<b>Název v MN</b>	<b>Počet</b>	<b>SIČ</b>	<b>Název</b>
1	Top track	2	XND0000033	Vodící profil, JG-AL0879-04L (851,5 mm)
2	Channel cap extrusion	2	XND0000120	Krytka profilu SJ1103 - Black
3	Wall track	2	XND0000064	Ustavovací profil, JG-AL0880-04 (1950 mm)
4	Channel cap	2	XND0000121	Profil JG-AL0882-04 (1879 mm) - Black
5	Fixed panel	2	XND0000096	Sklo 6,0x1900x338čiré BL-S22 Ravak-04
6	Top wheels	4	XND0000136	Horní kolečko dveří HL046 - Black
7	Wall anchor	8	XND0000061	Kotva AQ průměr 6
8	ST4x40 Screw	8	XND0000094	Vrut BLS 4x40
9	Fixed panel seal strip	2	XND0000133	Těsnící profil 304-06-24 (1877 mm) - Black
10	Door panel seal strip	2	XND0000134	Těsnící profil 304-06-24 (1935 mm) - Black
11	Door panel	2	XND0000082	Sklo 6,0x1935x450čiré BL-S22 Ravak-03
12	Magnet seal	2	XND0000116	Magnet 308GA-6, (1935 mm) - Black
13	Handle	1	XND0000113	Madlo JG-AL0888-01 - Black
13	Handle	1	XND0000114	Madlo JG-AL0888-02 - Black
13	Handle	1	XND0000115	Záslepka madla SJ1050, sada 4ks - Black
13	Handle	2	XND0000018	Šroub madla 8x6x4, sada 2ks
14	Bottom wheels	2	XND0000109	Spodní kolečko dveří HL047 - Black
15	Bottom track	2	XND0000037	Vodící profil, JG-AL0879-04R (851,5 mm)
16	Track connector	2	XND0000110	Rohová spojka ZJ552 - Black
17	Handle cap	4	XND0000112	Krytka madla SJ744 - Black

## **BLSRV2 – 90 black**

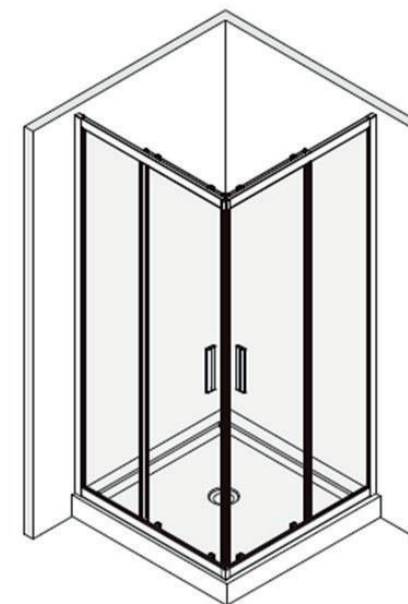

# BLSDP2 – 100

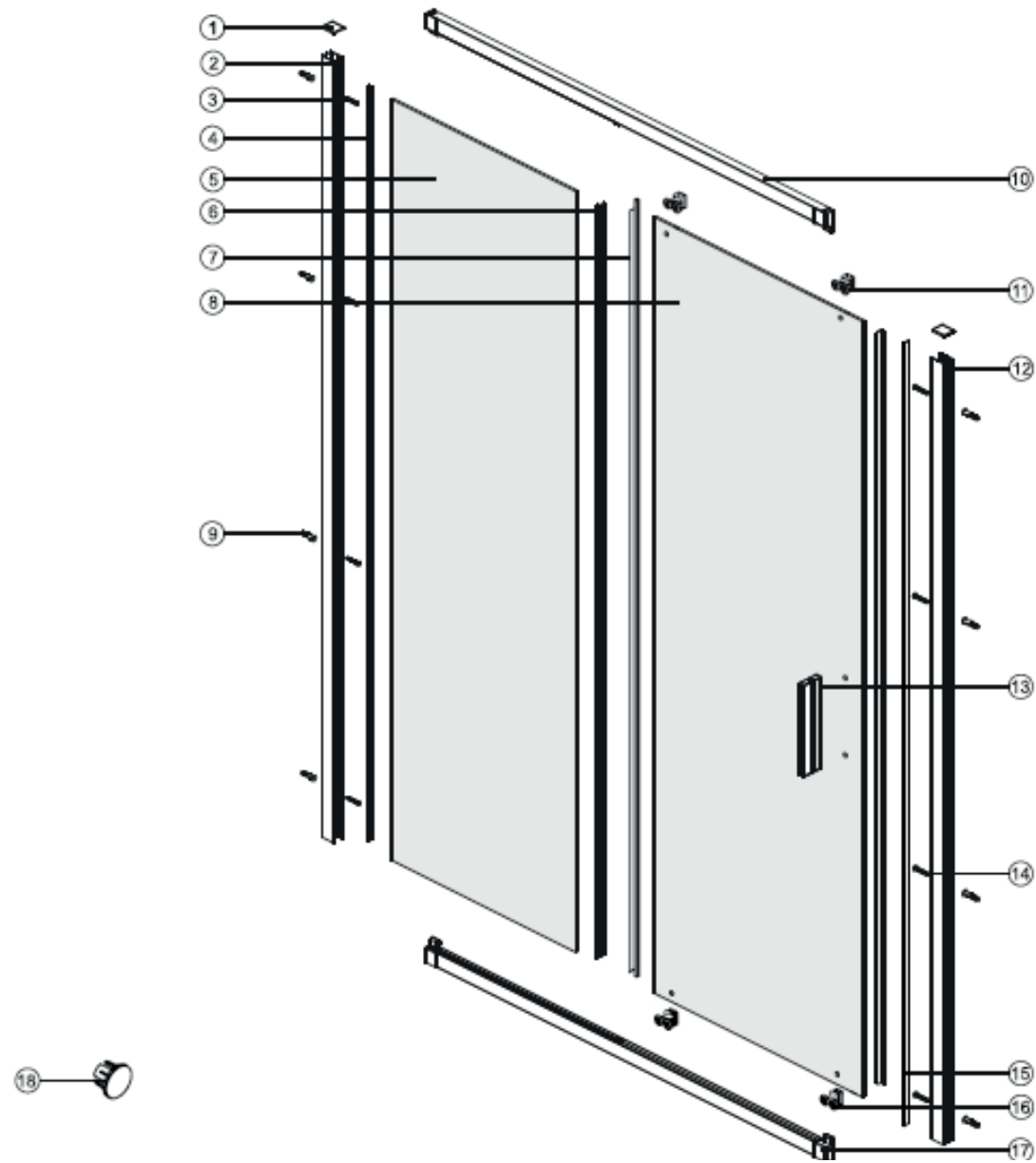



<b>BLSDP2 – 100 bright alu</b>				
<b>Číslo dílu</b>	<b>Název v MN</b>	<b>Počet</b>	<b>SIČ</b>	<b>Název</b>
1	Profile cap	2	XND0000148	Krytka profilu SJ1103
2	Wall jamb	1	XND0000064	Ustavovací profil, JG-AL0880-04 (1950 mm)
3	ST4x40 Screw	4	XND0000094	Vrut BLS 4x40
4	Wall profile cap	2	XND0000026	Profil JG-AL0882-04 (1879 mm)
5	Fixed panel	1	XND0000085	Sklo 6,0x1900x452 čiré BL-S22 Ravak-09
6	Fixed panel seal strip	1	XND0000043	Těsnící profil 304-06-24 (1877 mm)
7	Door panel seal strip	1	XND0000045	Těsnící profil 304-06-24 (1936 mm)
8	Moving door	1	XND0000084	Sklo 6,0x1936x522 čiré BL-S22 Ravak-08
9	Wall anchor	8	XND0000061	Kotva AQ průměr 6
10	Rail	1	XND0000034	Vodící profil, JG-AL0895-16L (956,5 mm)
11	Top wheels	2	XND0000055	Horní kolečko dveří HL046
12	Wall jamb	1	XND0000091	Ustavovací profil DP2, JG-AL0887-04 (1950 mm)
13	Handle	1	XND0000015	Madlo JG-AL0888-01
13	Handle	1	XND0000016	Madlo JG-AL0888-02
13	Handle	1	XND0000017	Záslepka madla SJ1050, sada 4ks
13	Handle	2	XND0000018	Šroub madla 8x6x4, sada 2ks
14	ST4x50 Screw	4	XND0000095	Vrut BLS 4x50
15	Water retaining gasket	1	XND0000009	Těsnění JT0296 (1947)
16	Bottom wheels	2	XND0000002	Spodní kolečko dveří HL047
17	Rail	1	XND0000038	Vodící profil, JG-AL0895-16R (956,5 mm)
18	Handle cap	2	XND0000014	Krytka madla SJ744

## **BLSDP2 – 100 bright alu**

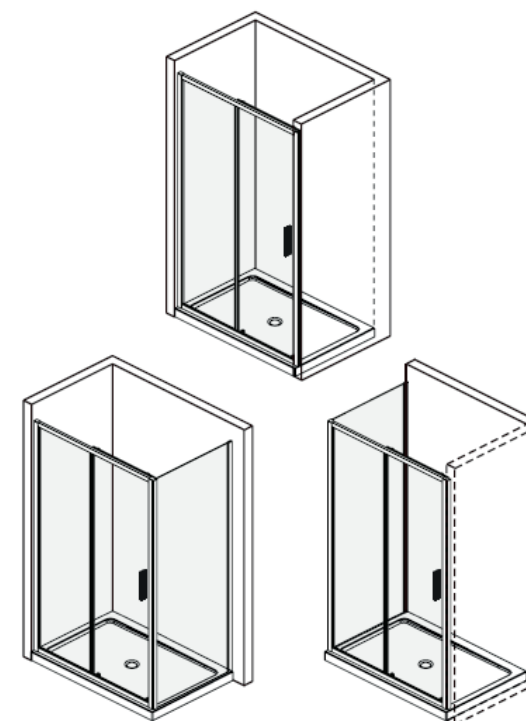

<b>BLSDP2 – 100 black</b>				
<b>Číslo dílu</b>	<b>Název v MN</b>	<b>Počet</b>	<b>SIČ</b>	<b>Název</b>
1	Profile cap	2	XND0000120	Krytka profilu SJ1103 - Black
2	Wall jamb	1	XND0000139	Ustavovací profil, JG-AL0880-04 (1950 mm) - Black
3	ST4x40 Screw	4	XND0000094	Vrut BLS 4x40
4	Wall profile cap	2	XND0000121	Profil JG-AL0882-04 (1879 mm) - Black
5	Fixed panel	1	XND0000085	Sklo 6,0x1900x452 čiré BL-S22 Ravak-09
6	Fixed panel seal strip	1	XND0000133	Těsnící profil 304-06-24 (1877 mm) - Black
7	Door panel seal strip	1	XND0000135	Těsnící profil 304-06-24 (1936 mm) - Black
8	Moving door	1	XND0000084	Sklo 6,0x1936x522 čiré BL-S22 Ravak-08
9	Wall anchor	8	XND0000061	Kotva AQ průměr 6
10	Rail	1	XND0000124	Vodící profil, JG-AL0895-16L (956,5 mm) - Black
11	Top wheels	2	XND0000136	Horní kolečko dveří HL046 - Black
12	Wall jamb	1	XND0000140	Ustavovací profil DP2, JG-AL0887-04 (1950 mm) - Black
13	Handle	1	XND0000113	Madlo JG-AL0888-01 - Black
13	Handle	1	XND0000114	Madlo JG-AL0888-02 - Black
13	Handle	1	XND0000115	Záslepka madla SJ1050, sada 4ks - Black
13	Handle	2	XND0000018	Šroub madla 8x6x4, sada 2ks
14	ST4x50 Screw	4	XND0000095	Vrut BLS 4x50
15	Water retaining gasket	1	XND0000009	Těsnění JT0296 (1947)
16	Bottom wheels	2	XND0000109	Spodní kolečko dveří HL047 - Black
17	Rail	1	XND0000128	Vodící profil, JG-AL0895-16R (956,5 mm) - Black
18	Handle cap	2	XND0000112	Krytka madla SJ744 - Black

## **BLSDP2 – 100 black**

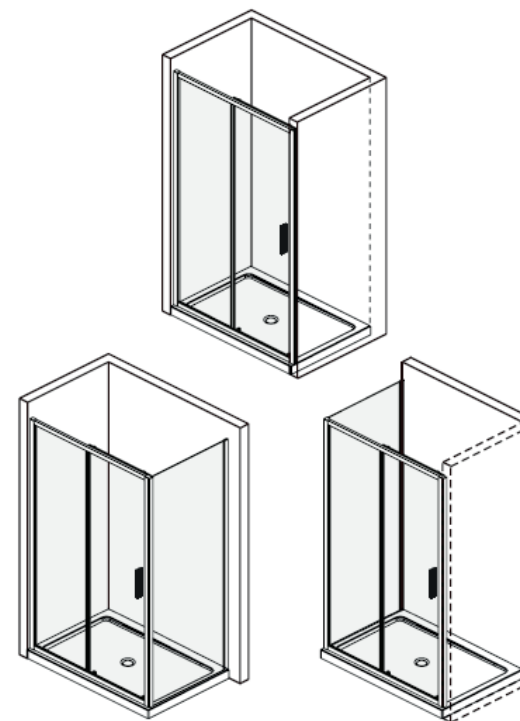

# BLSDP2 – 120

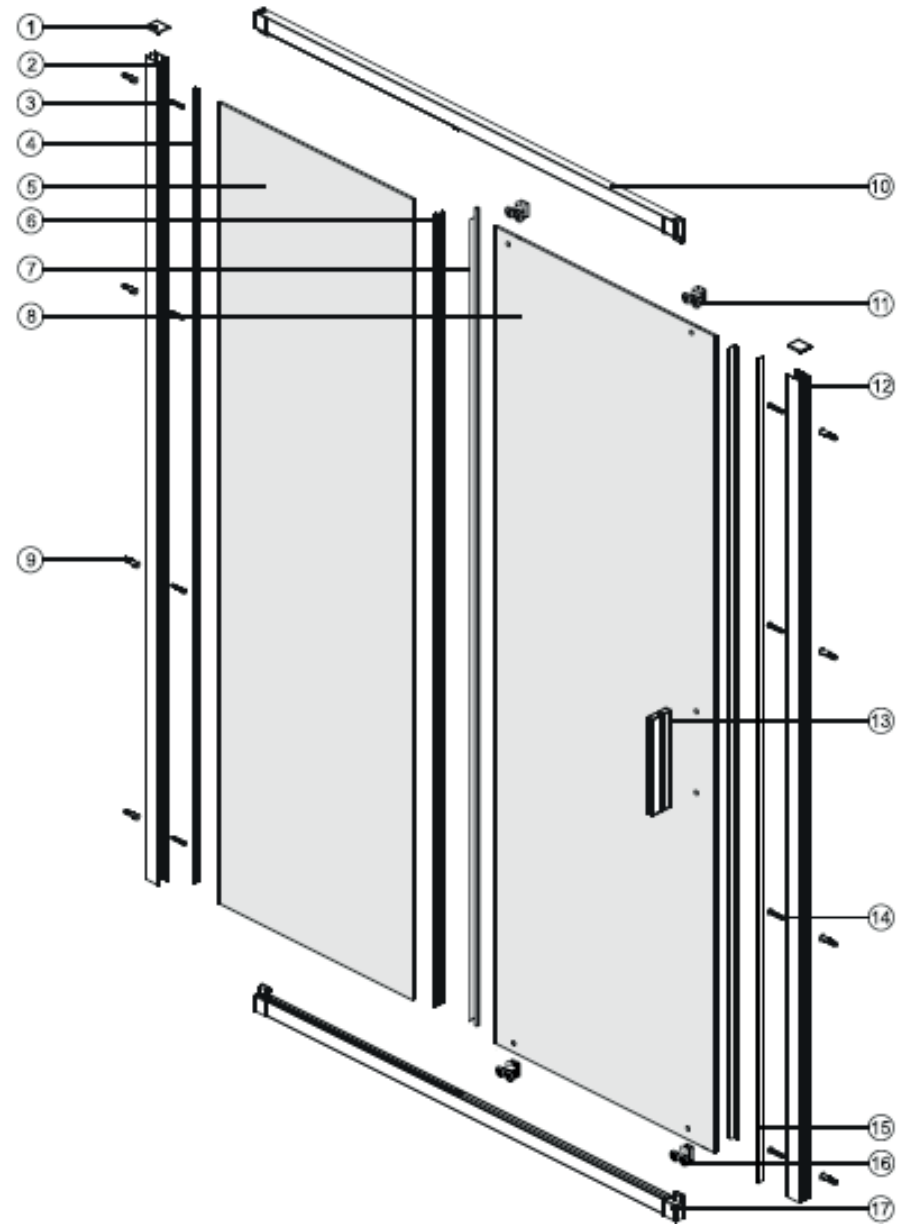



<b>BLSDP2 – 120 bright alu</b>				
<b>Číslo dílu</b>	<b>Název v MN</b>	<b>Počet</b>	<b>SIČ</b>	<b>Název</b>
1	Profile cap	2	XND0000148	Krytka profilu SJ1103
2	Wall jamb	1	XND0000064	Ustavovací profil, JG-AL0880-04 (1950 mm)
3	ST4x40 Screw	4	XND0000094	Vrut BLS 4x40
4	Wall profile cap	2	XND0000026	Profil JG-AL0882-04 (1879 mm)
5	Fixed panel	1	XND0000087	Sklo 6,0x1900x552 čiré BL-S22 Ravak-11
6	Fixed panel seal strip	1	XND0000043	Těsnící profil 304-06-24 (1877 mm)
7	Door panel seal strip	1	XND0000045	Těsnící profil 304-06-24 (1936 mm)
8	Moving door	1	XND0000086	Sklo 6,0x1936x622 čiré BL-S22 Ravak-10
9	Wall anchor	8	XND0000061	Kotva AQ průměr 6
10	Rail	1	XND0000035	Vodící profil, JG-AL0895-17L (1156,5 mm)
11	Top wheels	2	XND0000055	Horní kolečko dveří HL046
12	Wall jamb	1	XND0000091	Ustavovací profil DP2, JG-AL0887-04 (1950 mm)
13	Handle	1	XND0000015	Madlo JG-AL0888-01
13	Handle	1	XND0000016	Madlo JG-AL0888-02
13	Handle	1	XND0000017	Záslepka madla SJ1050, sada 4ks
13	Handle	2	XND0000018	Šroub madla 8x6x4, sada 2ks
14	ST4x50 Screw	4	XND0000095	Vrut BLS 4x50
15	Water retaining gasket	1	XND0000009	Těsnění JT0296 (1947)
16	Bottom wheels	2	XND0000002	Spodní kolečko dveří HL047
17	Rail	1	XND0000039	Vodící profil, JG-AL0895-17R (1156,5 mm)
18	Handle cap	2	XND0000014	Krytka madla SJ744

## **BLSDP2 – 120 bright alu**

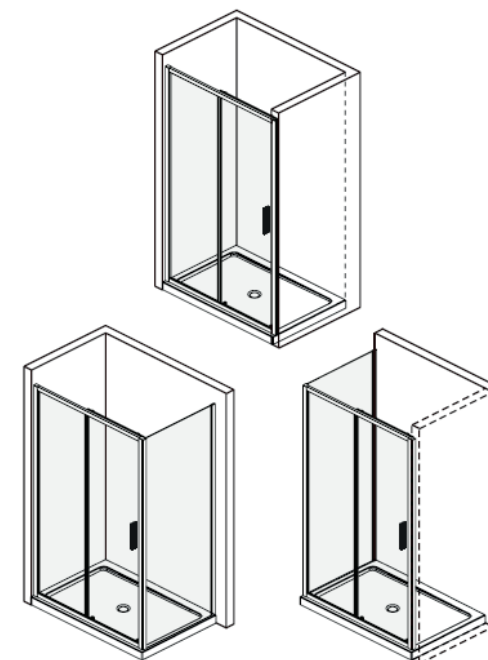



<b>BLSDP2 – 120 black</b>				
<b>Číslo dílu</b>	<b>Název v MN</b>	<b>Počet</b>	<b>SIČ</b>	<b>Název</b>
1	Profile cap	2	XND0000120	Krytka profilu SJ1103 - Black
2	Wall jamb	1	XND0000139	Ustavovací profil, JG-AL0880-04 (1950 mm) - Black
3	ST4x40 Screw	4	XND0000094	Vrut BLS 4x40
4	Wall profile cap	2	XND0000121	Profil JG-AL0882-04 (1879 mm) - Black
5	Fixed panel	1	XND0000087	Sklo 6,0x1900x552 čiré BL-S22 Ravak-11
6	Fixed panel seal strip	1	XND0000133	Těsnící profil 304-06-24 (1877 mm) - Black
7	Door panel seal strip	1	XND0000135	Těsnící profil 304-06-24 (1936 mm) - Black
8	Moving door	1	XND0000086	Sklo 6,0x1936x622 čiré BL-S22 Ravak-10
9	Wall anchor	8	XND0000061	Kotva AQ průměr 6
10	Rail	1	XND0000125	Vodící profil, JG-AL0895-17L (1156,5 mm) - Black
11	Top wheels	2	XND0000136	Horní kolečko dveří HL046 - Black
12	Wall jamb	1	XND0000140	Ustavovací profil DP2, JG-AL0887-04 (1950 mm) - Black
13	Handle	1	XND0000113	Madlo JG-AL0888-01 - Black
13	Handle	1	XND0000114	Madlo JG-AL0888-02 - Black
13	Handle	1	XND0000115	Záslepka madla SJ1050, sada 4ks - Black
13	Handle	2	XND0000018	Šroub madla 8x6x4, sada 2ks
14	ST4x50 Screw	4	XND0000095	Vrut BLS 4x50
15	Water retaining gasket	1	XND0000009	Těsnění JT0296 (1947)
16	Bottom wheels	2	XND0000109	Spodní kolečko dveří HL047 - Black
17	Rail	1	XND0000129	Vodící profil, JG-AL0895-17R (1156,5 mm) - Black
18	Handle cap	2	XND0000112	Krytka madla SJ744 - Black

# BLSDP2 – 120 black

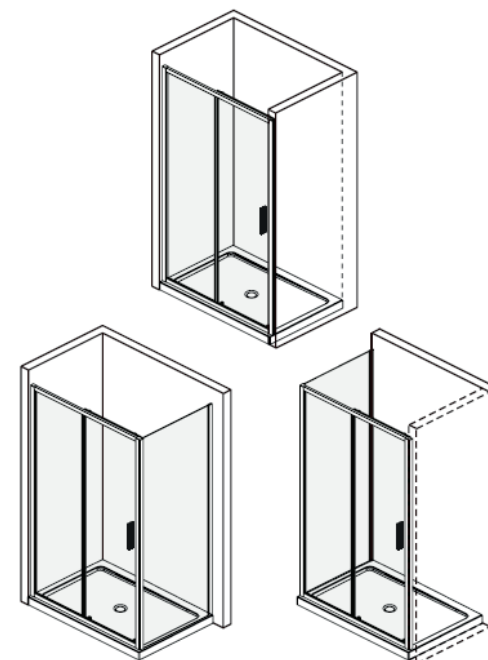

# BLSPS – 80

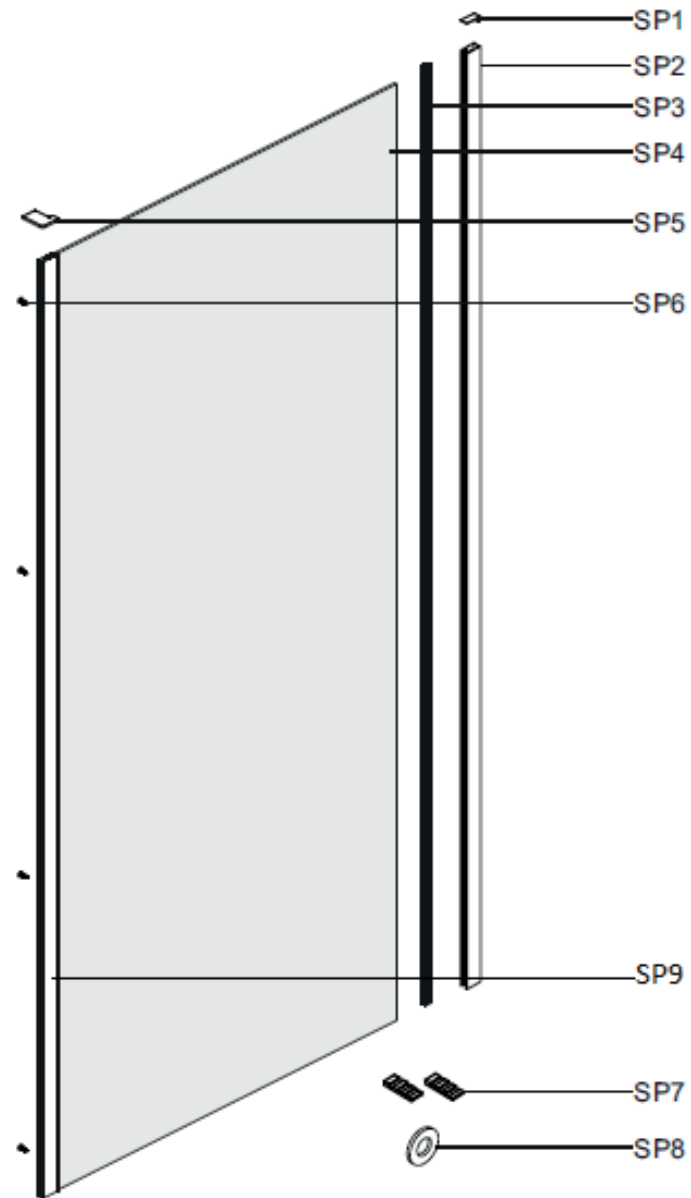



<b>BLSPS – 80 bright alu</b>				
<b>Číslo dílu</b>	<b>Název v MN</b>	<b>Počet</b>	<b>SIČ</b>	<b>Název</b>
SP1	Profile cap	1	XND0000062	Krytka profilu SJ559
SP2	Wall jamb	1	XND0000063	Ustavovací profil, JG-AL0408-07 (1950 mm)
SP3	Squeeze gasket	1	XND0000050	Těsnící pr. R1001C (1950 mm)
SP4	Fixed panel	1	XND0000089	Sklo 6,0x1950x752 čiré BL-S22 Ravak-13
SP5	Profile cap L/R	1	XND0000023	Krytka profilu SJ1048L
SP5	Profile cap L/R	1	XND0000024	Krytka profilu SJ1048R
SP6	ST4x30 Screw	4	XND0000093	Vrut BLS 4x30
SP7	Glass wedge spacer	2	XND0000047	Podložka SJ183
SP8	Washer	4	XND0000090	Podložka pr.10x5x1
SP9	Corner profile	1	XND0000007	Rohový profil JG-AL0886-04 (1950 mm)

## **BLSPS – 80 bright alu**

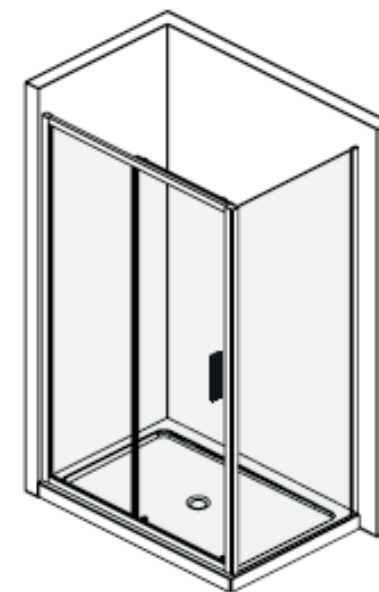

<b>BLSPS – 80 black</b>				
<b>Číslo dílu</b>	<b>Název v MN</b>	<b>Počet</b>	<b>SIČ</b>	<b>Název</b>
SP1	Profile cap	1	XND0000137	Krytka profilu SJ559 - Black
SP2	Wall jamb	1	XND0000138	Ustavovací profil, JG-AL0408-07 (1950 mm) - Black
SP3	Squeeze gasket	1	XND0000050	Těsnící pr. R1001C (1950 mm)
SP4	Fixed panel	1	XND0000089	Sklo 6,0x1950x752 čiré BL-S22 Ravak-13
SP5	Profile cap L/R	1	XND0000023	Krytka profilu SJ1048L
SP5	Profile cap L/R	1	XND0000024	Krytka profilu SJ1048R
SP6	ST4x30 Screw	4	XND0000093	Vrut BLS 4x30
SP7	Glass wedge spacer	2	XND0000047	Podložka SJ183
SP8	Washer	4	XND0000090	Podložka pr.10x5x1
SP9	Corner profile	1	XND0000007	Rohový profil JG-AL0886-04 (1950 mm)

## **BLSPS – 80 black**

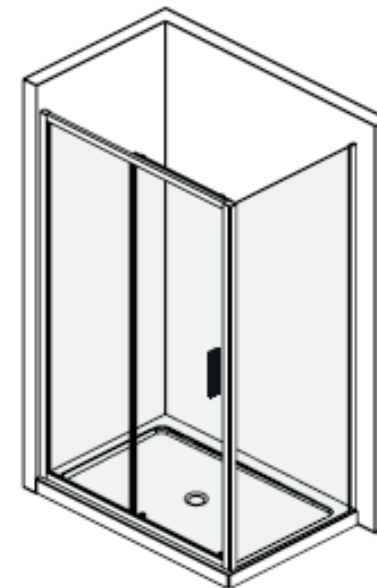

# BLSPS – 90

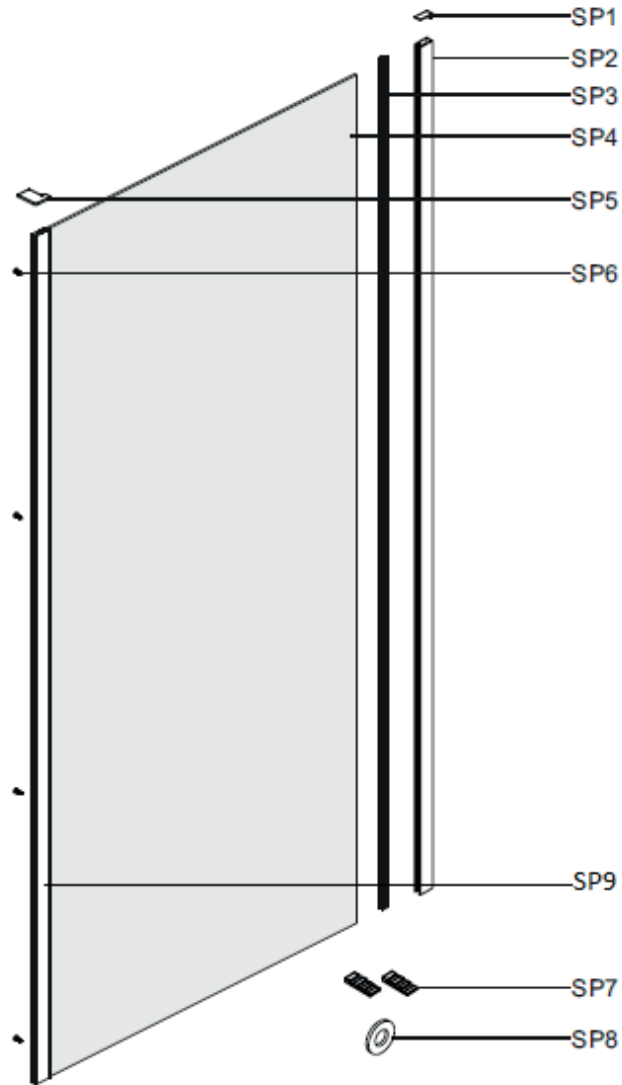



<b>BLSPS – 90 bright alu</b>				
<b>Číslo dílu</b>	<b>Název v MN</b>	<b>Počet</b>	<b>SIČ</b>	<b>Název</b>
SP1	Profile cap	1	XND0000062	Krytka profilu SJ559
SP2	Wall jamb	1	XND0000063	Ustavovací profil, JG-AL0408-07 (1950 mm)
SP3	Squeeze gasket	1	XND0000050	Těsnící pr. R1001C (1950 mm)
SP4	Fixed panel	1	XND0000088	Sklo 6,0x1950x852 čiré BL-S22 Ravak-12
SP5	Profile cap L/R	1	XND0000023	Krytka profilu SJ1048L
SP5	Profile cap L/R	1	XND0000024	Krytka profilu SJ1048R
SP6	ST4x30 Screw	4	XND0000093	Vrut BLS 4x30
SP7	Glass wedge spacer	2	XND0000047	Podložka SJ183
SP8	Washer	4	XND0000090	Podložka pr.10x5x1
SP9	Corner profile	1	XND0000007	Rohový profil JG-AL0886-04 (1950 mm)

## **BLSPS – 90 bright alu**

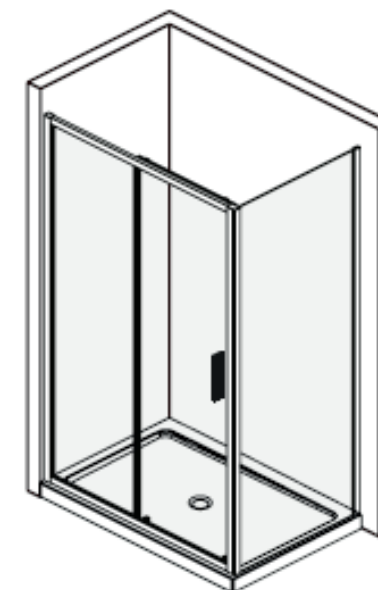



<b>BLSPS – 90 black</b>				
<b>Číslo dílu</b>	<b>Název v MN</b>	<b>Počet</b>	<b>SIČ</b>	<b>Název</b>
SP1	Profile cap	1	XND0000137	Krytka profilu SJ559 - Black
SP2	Wall jamb	1	XND0000138	Ustavovací profil, JG-AL0408-07 (1950 mm) - Black
SP3	Squeeze gasket	1	XND0000050	Těsnící pr. R1001C (1950 mm)
SP4	Fixed panel	1	XND0000088	Sklo 6,0x1950x852 čiré BL-S22 Ravak-12
SP5	Profile cap L/R	1	XND0000023	Krytka profilu SJ1048L
SP5	Profile cap L/R	1	XND0000024	Krytka profilu SJ1048R
SP6	ST4x30 Screw	4	XND0000093	Vrut BLS 4x30
SP7	Glass wedge spacer	2	XND0000047	Podložka SJ183
SP8	Washer	4	XND0000090	Podložka pr.10x5x1
SP9	Corner profile	1	XND0000007	Rohový profil JG-AL0886-04 (1950 mm)

## **BLSPS – 90 black**

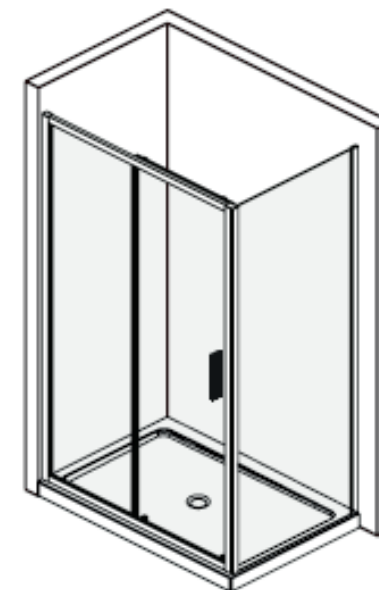





**RAVAK a.s.**, Obecnická 285, 261 01 Příbram I, ČR  
tel.: +420 318 427 111, fax: +420 318 427 278. e-mail: [info@ravak.cz](mailto:info@ravak.cz), web: [www.ravak.cz](http://www.ravak.cz)

**RAVAK SLOVAKIA spol. s r.o.**, Einsteinová 11, 851 01 Bratislava  
tel.: +421 2 / 444 550 01, fax: +421 2 / 444 550 02, e-mail: [obchod@ravak.sk](mailto:obchod@ravak.sk), web: [www.ravak.sk](http://www.ravak.sk)

**RAVAK POLSKA S.A.**, Kałęczyn, ul. Radziejowicka 124, 05-825 Grodzisk Mazowiecki, POLSKA  
tel.: 22 / 755 40 30, fax: 22 / 755 43 90, e-mail: [info@ravak.pl](mailto:info@ravak.pl), web: [www.ravak.pl](http://www.ravak.pl)

**RAVAK Hungary Kft.**, 1142 Budapest, Erzsébet királyné útja 125, HUNGARY  
tel.: 06 (1) 223 13 15, 06 (1) 223 13 16, fax: 06 (1) 223 13 14, e-mail: [info@ravak.hu](mailto:info@ravak.hu), web: [www.ravak.hu](http://www.ravak.hu)

**Ravak Gesellschaft** für Sanitärprodukte mbH, Alexanderstrasse 58, D - 45472 Mülheim an der Ruhr  
Tel. (0208) 37789-30 Fax. (0208) 37789-55, e-mail: [info@ravak.de](mailto:info@ravak.de), web: [www.ravak.de](http://www.ravak.de)

**RAVAK a.s.**, Representative Office in Ukraine, 21 Dniprovska Naberezhna str., 2nd floor, 02081, Kyiv, Ukraine  
tel.: 00380 44 2203232, 00380 44 3605200, fax: 00380 44 2204343, e-mail: [ravak@ravak.kiev.ua](mailto:ravak@ravak.kiev.ua), web: [www.ravak.ua](http://www.ravak.ua)

**OOO RAVAK ru.** ul. Staropetrovskiy pr. 7A, Moskva 125 130,  
tel./fax: 007 495 710 82 23, 007 495 450 12 77, e-mail: [ravak@inbox.ru](mailto:ravak@inbox.ru), web: [www.ravak.com](http://www.ravak.com)

# RAVAK®

**RAVAK a.s.**, Obecnická 285, 261 01 Příbram I  
tel.: +420 318 427 200, +420 318 427 111 fax: +420 318 427 269  
**[info@ravak.cz](mailto:info@ravak.cz), [www.ravak.com](http://www.ravak.com)**

Výrobce si vyhrazuje právo změny ceny, technických parametrů, či dalších skutečností  
bez předchozího upozornění a nenese odpovědnost za tiskové chyby.