

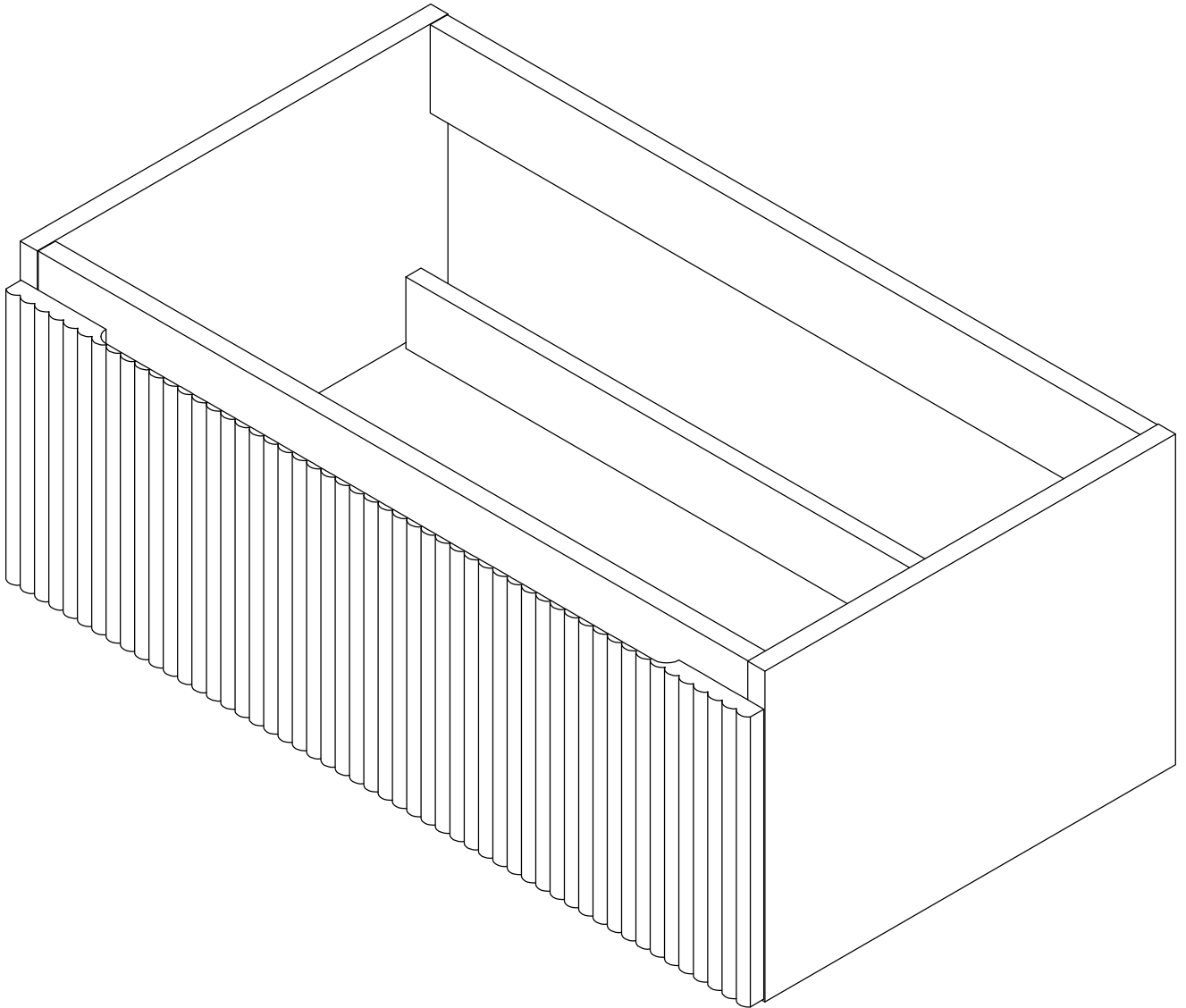

SAT

SATEVO100NA
SATEVO100WM



1

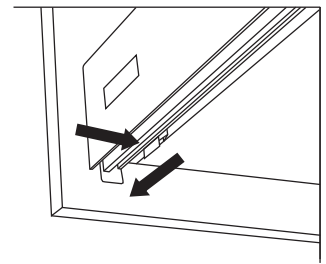
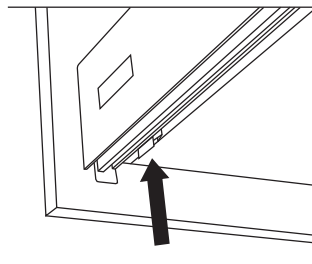
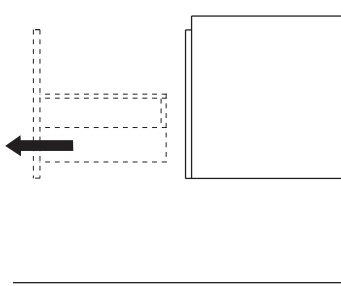

2

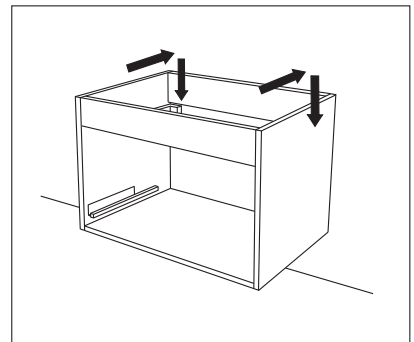
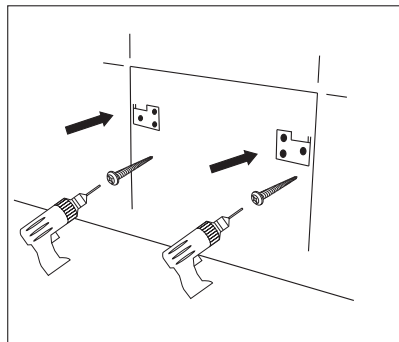
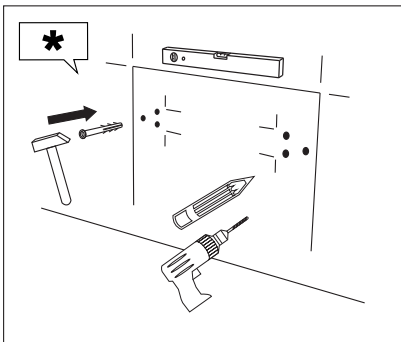
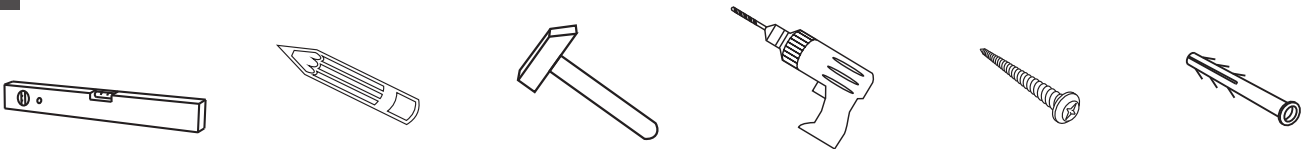

3

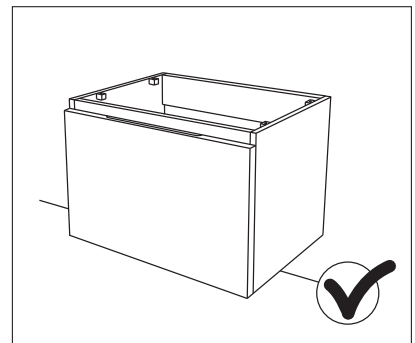
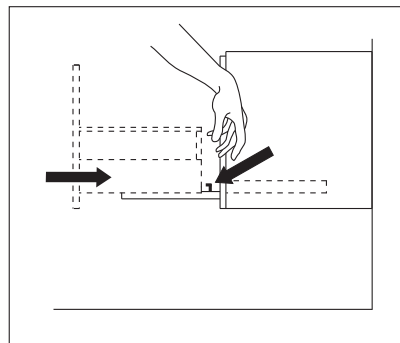
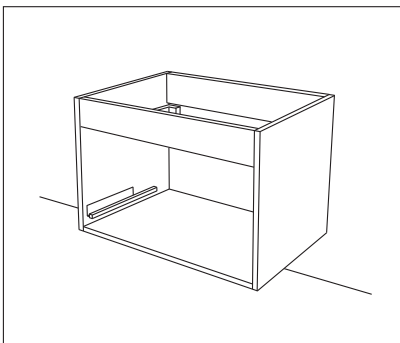

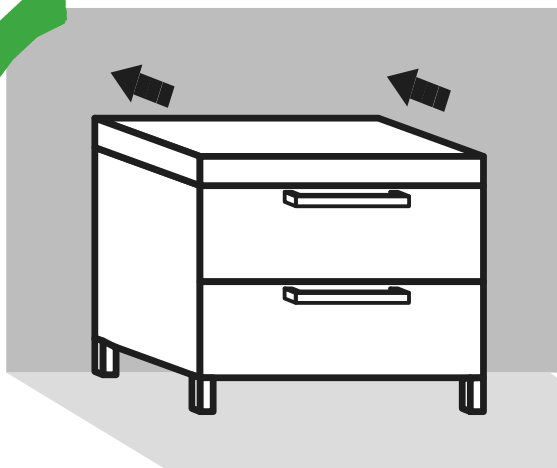
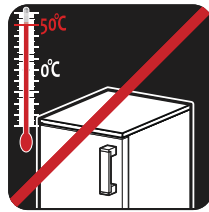
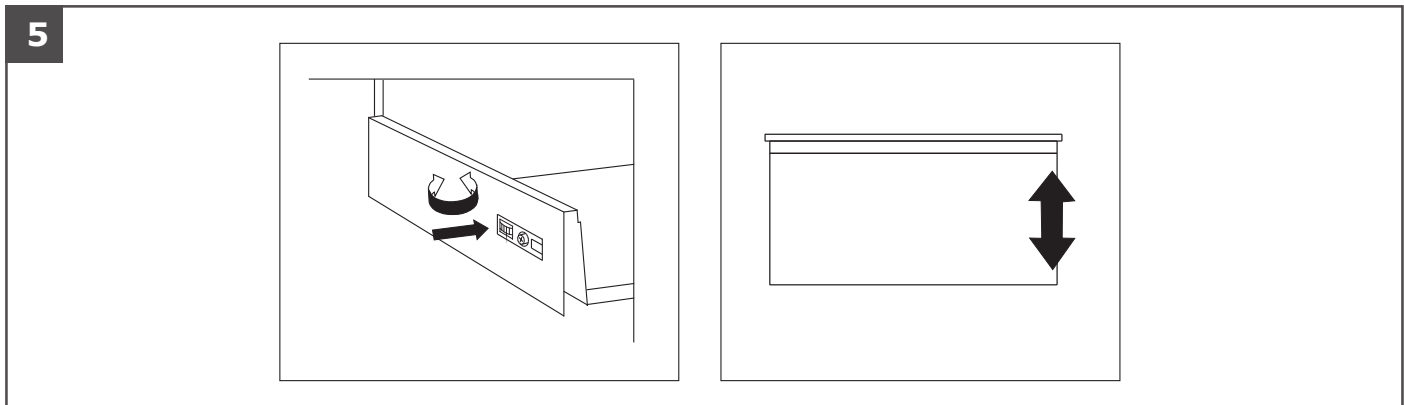
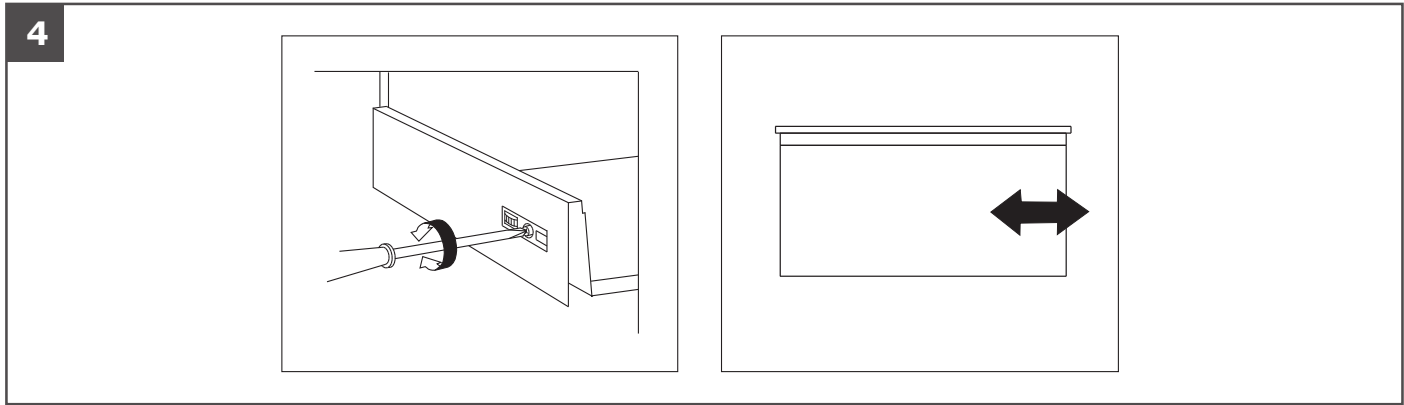

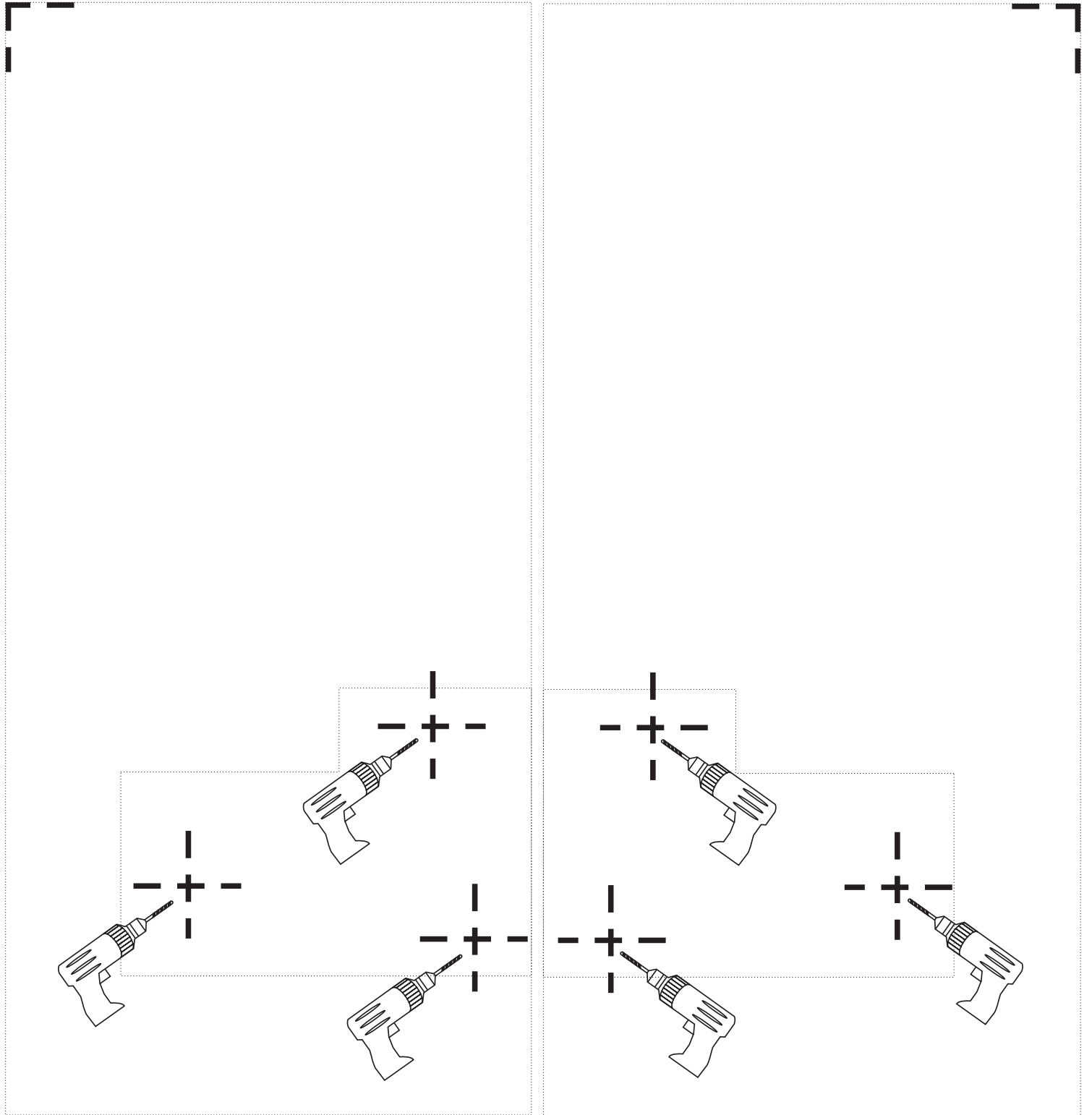
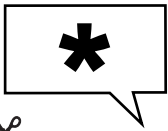

SAT® is registered trademark of



**Swiss
Aqua
Technologies**

Swiss Aqua Technologies AG
Gewerbstrasse 9, 6330 Cham, Switzerland
www.swatec.ch
Imported by SIKO KOUPELNY a.s.
Made in Czech Republic