

A1.

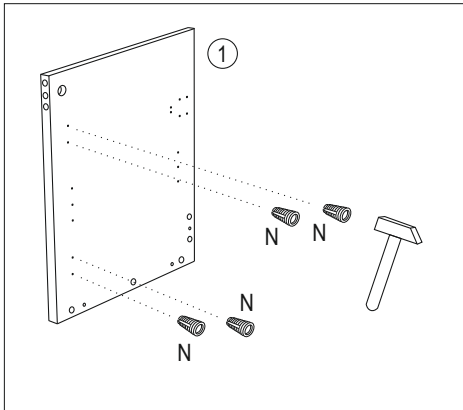

A2.

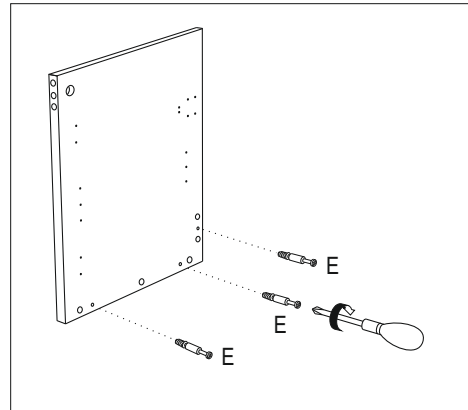

A3.

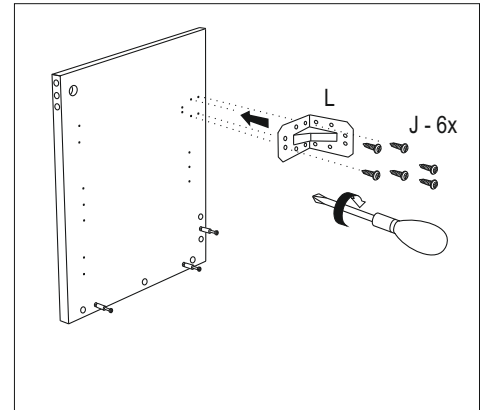

B1.

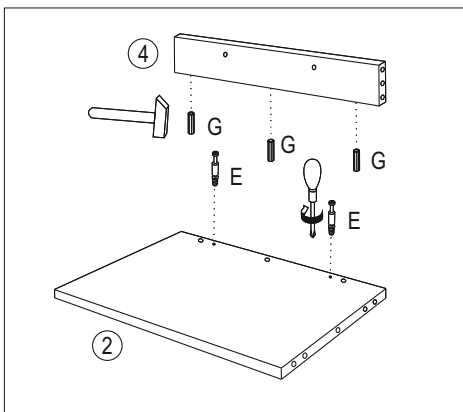

B2.

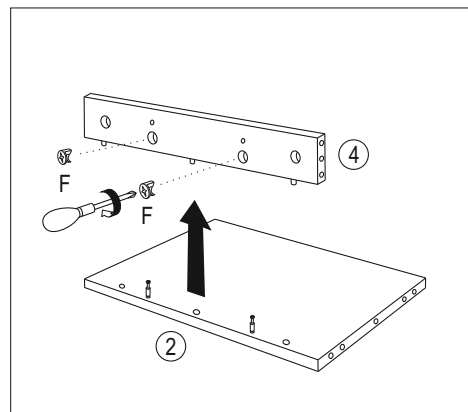

B3.

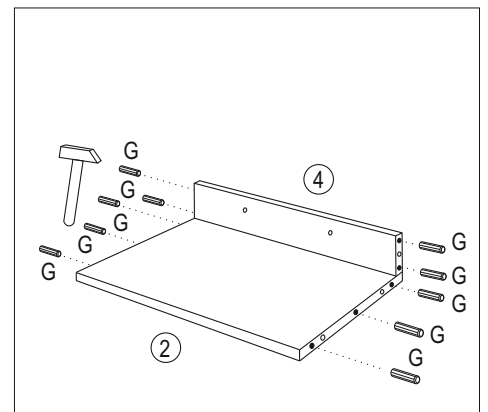

C1.

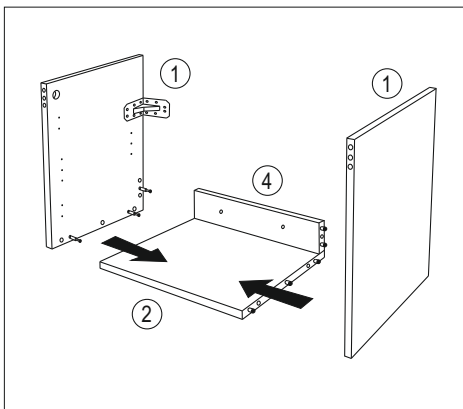

C2.

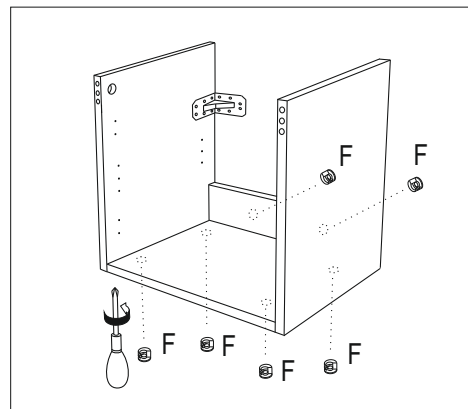

C3.

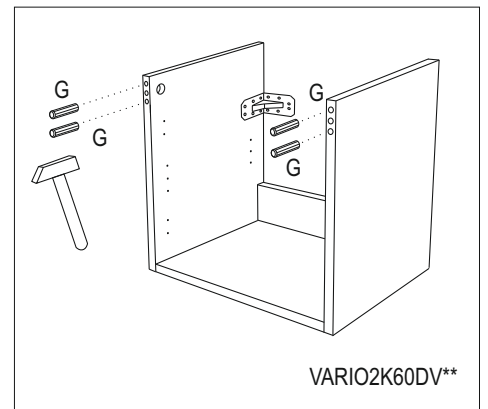

VARIO2K60DV**

D1.

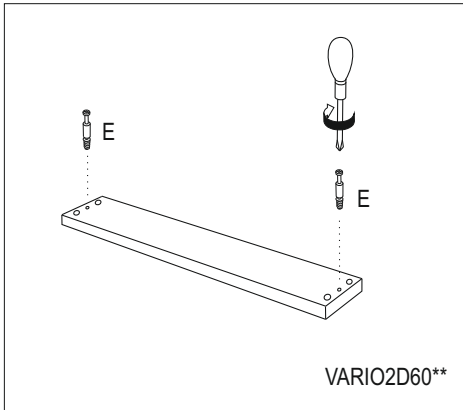

D2.

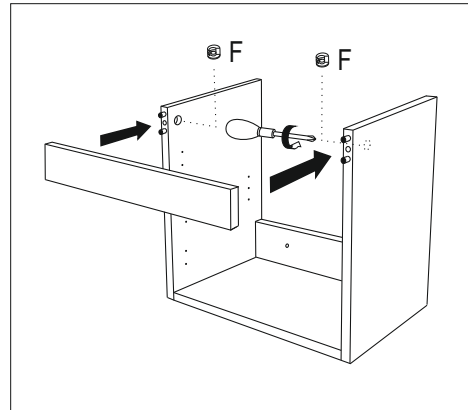

D.

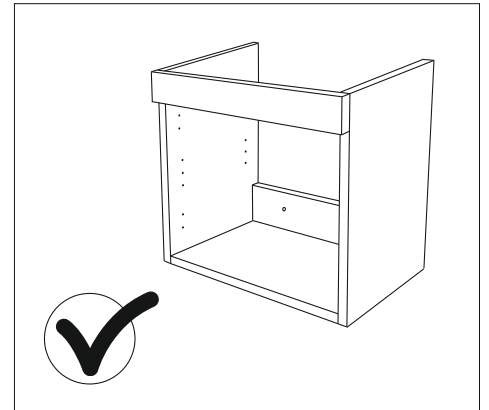

E1.

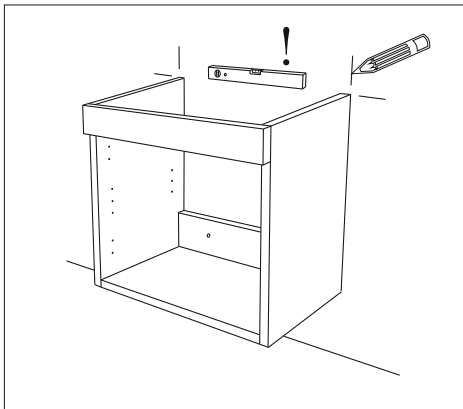

E2.

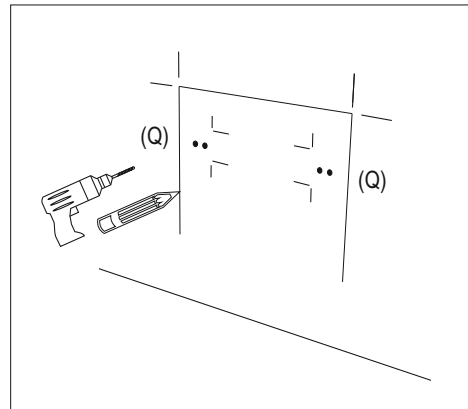

F1.

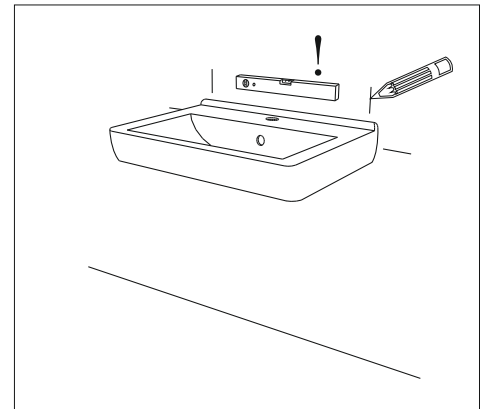

F2.

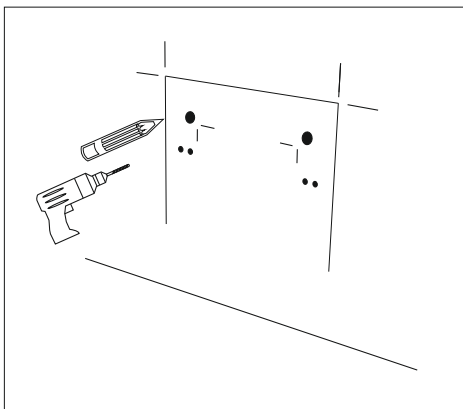

F3.

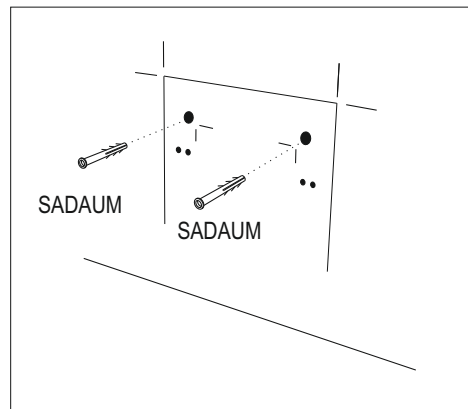

F4.

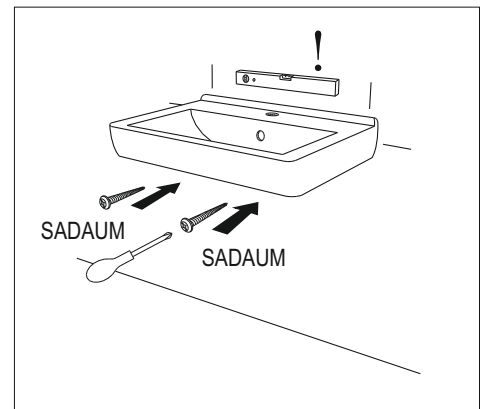

E3.

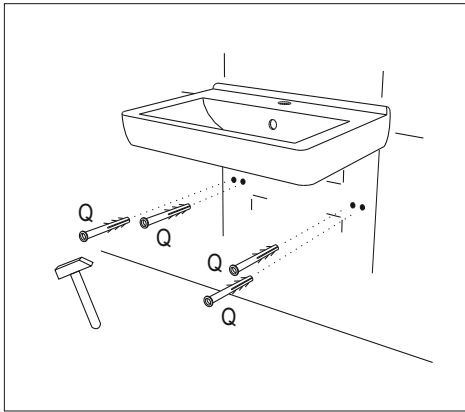

E4.

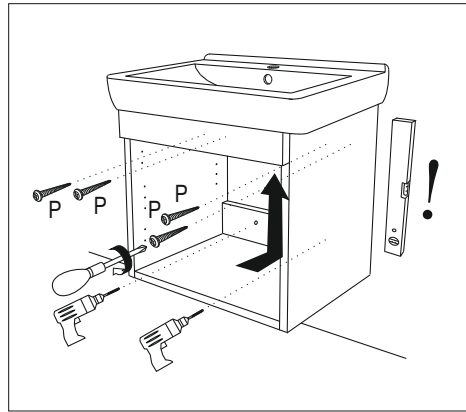

E5.

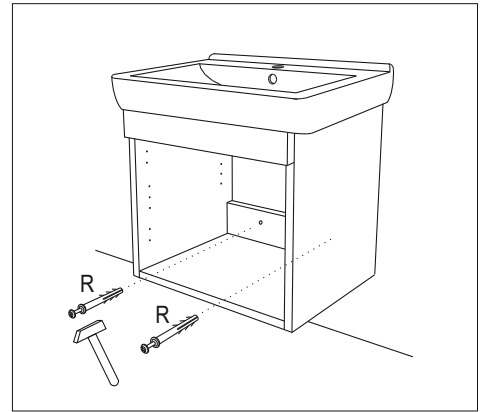

G1.

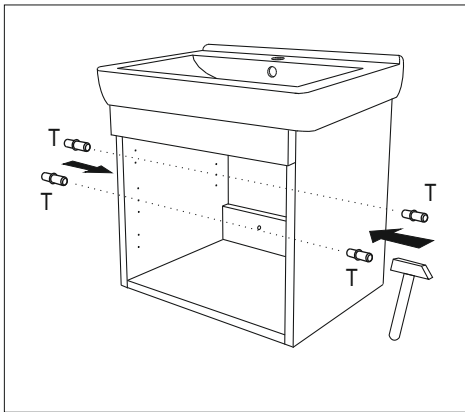

G2.

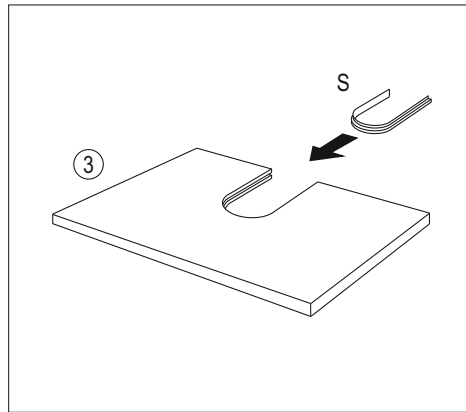

G3.

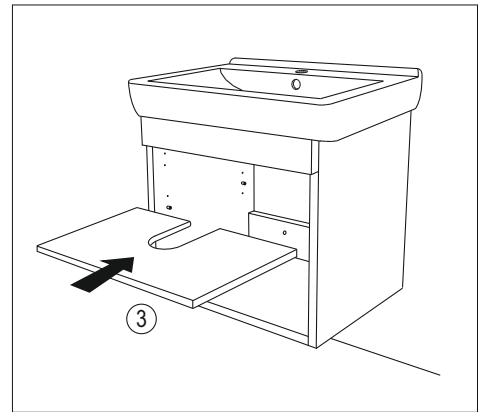

H1.

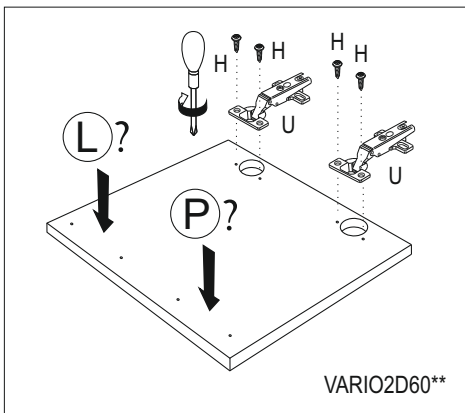

H2.

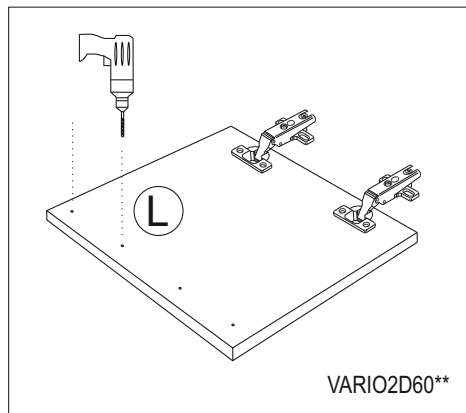

H3.

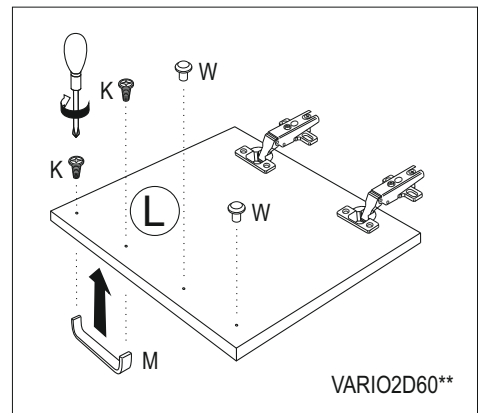

11.

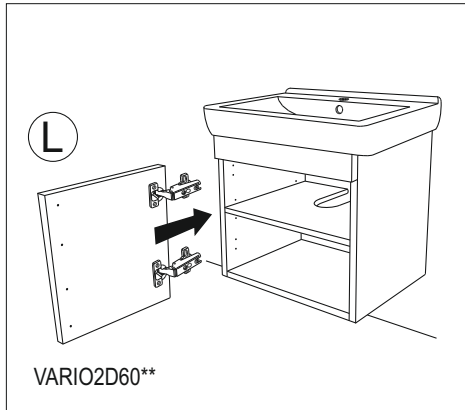

12.

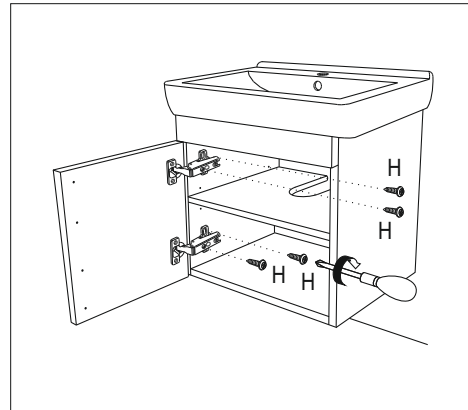

1.

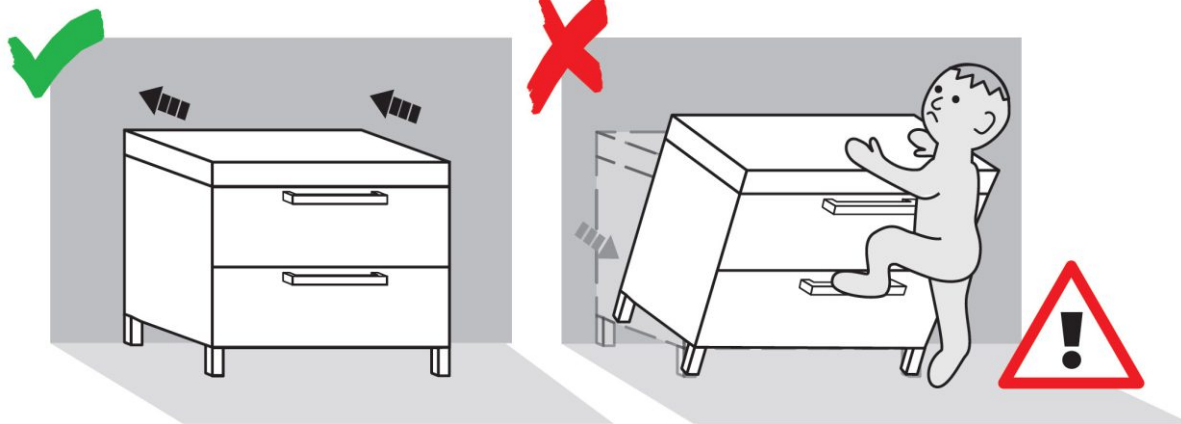
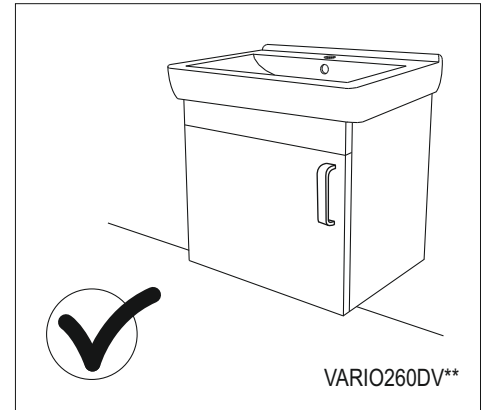

P - 6x80

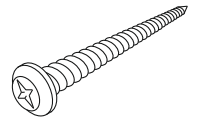

4x

Q - 8x80

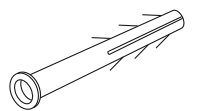

4x

R - 6x70

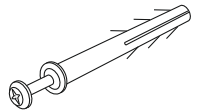

2x

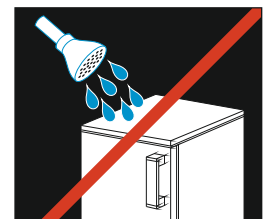
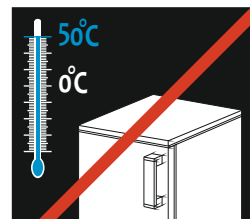
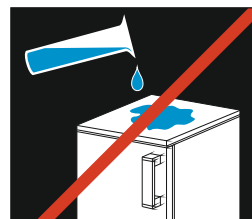
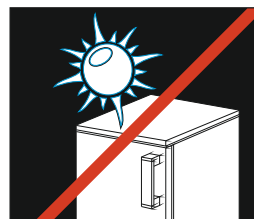
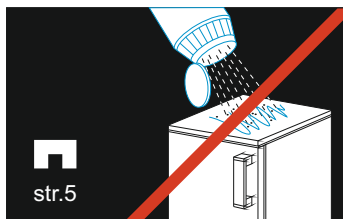

J1.

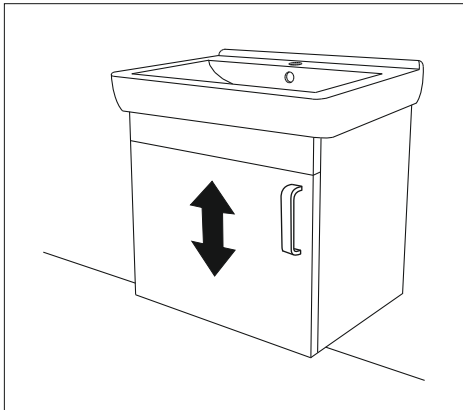

J2.

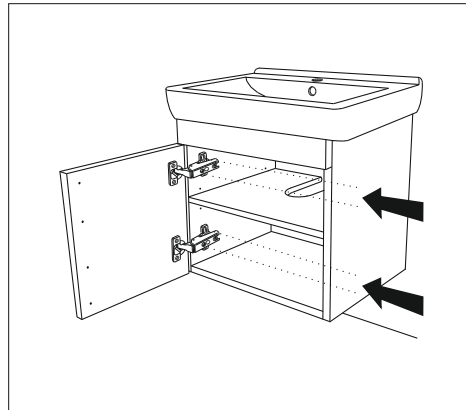

J3.

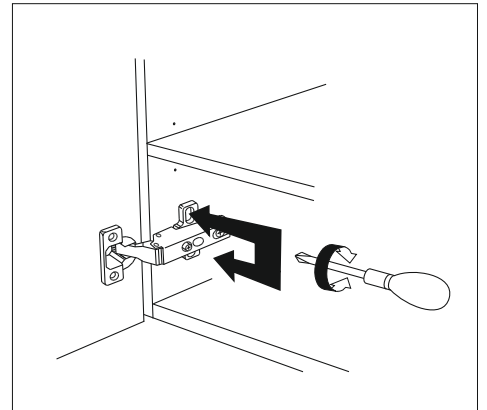

K1.

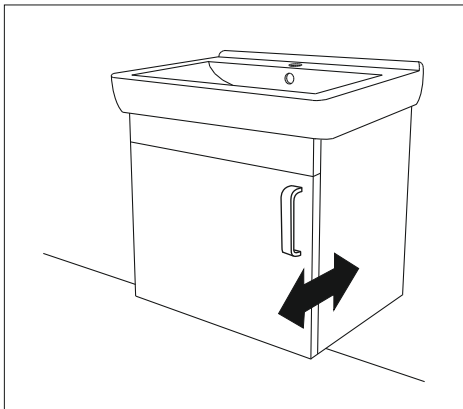

K2.

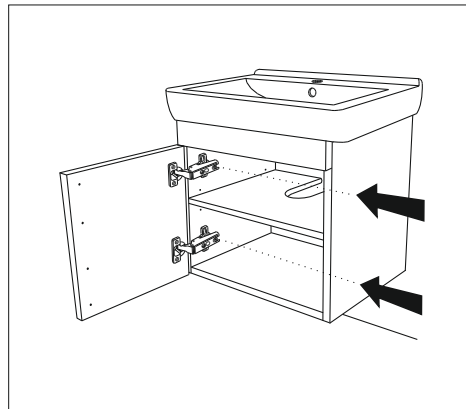

K3.

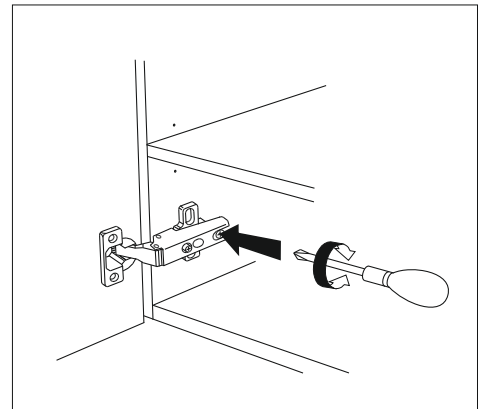

L1.

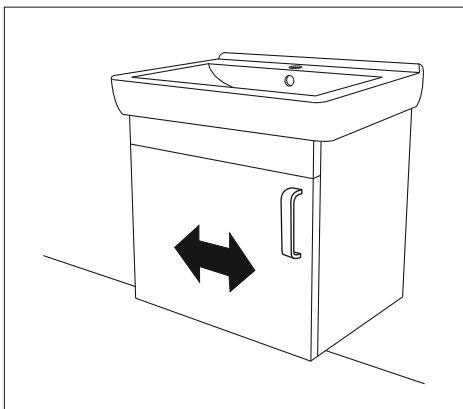

L2.

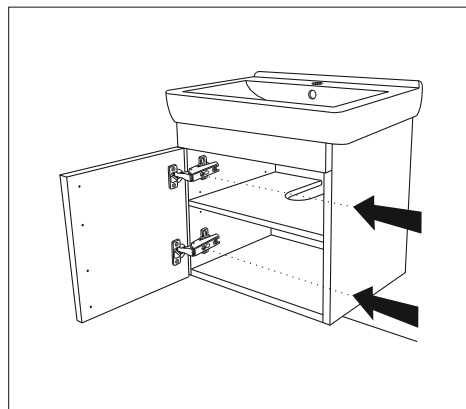

L3.

