

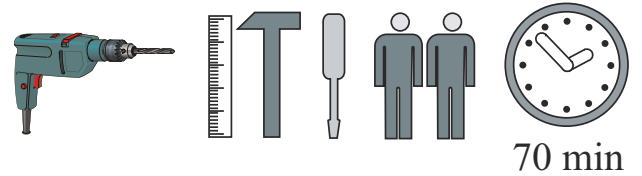

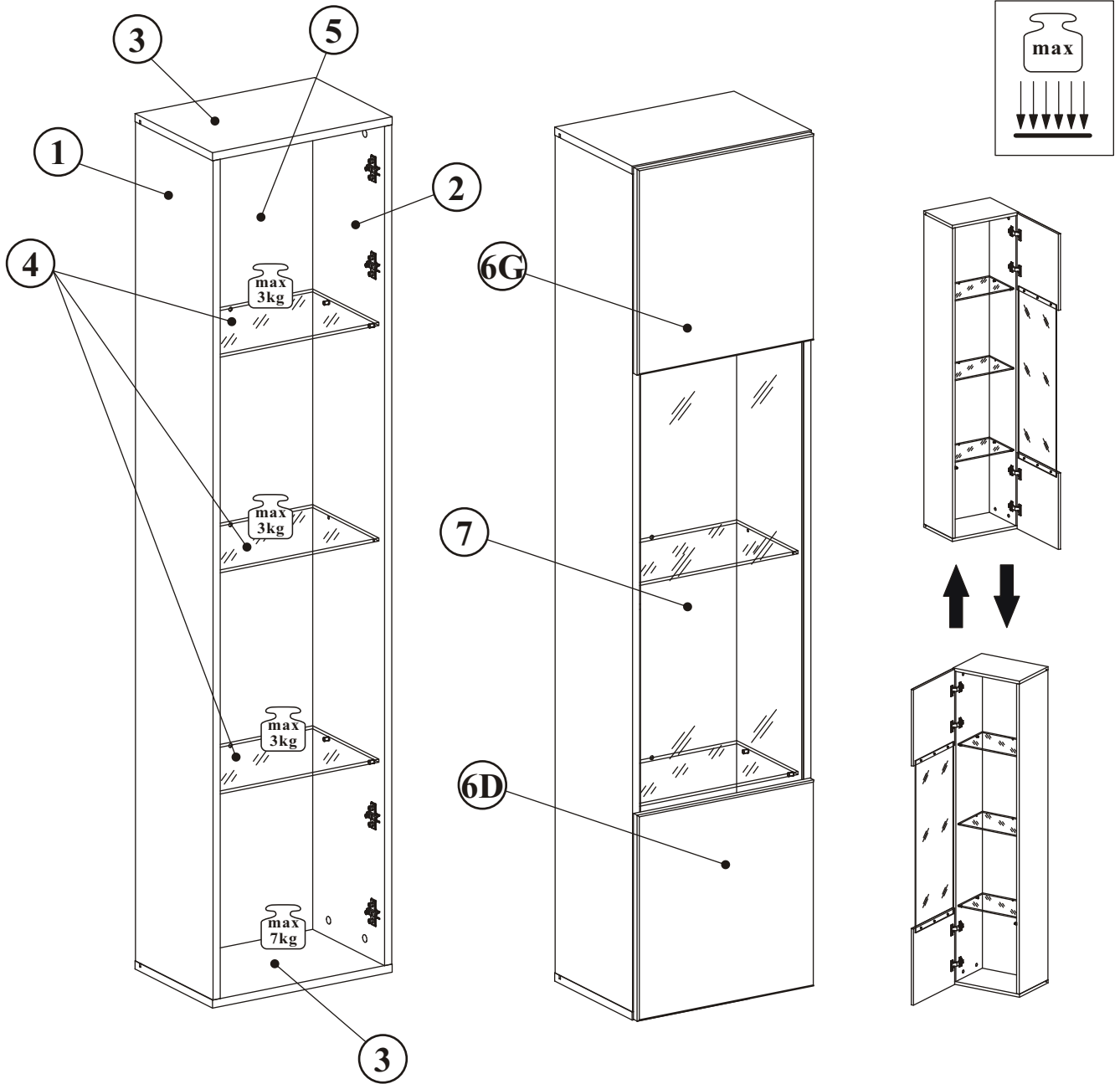

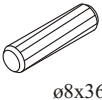

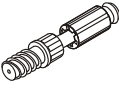

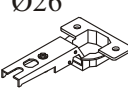
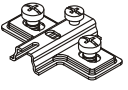
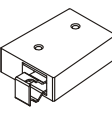

FLY TYP-42

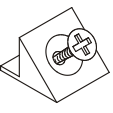

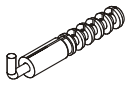
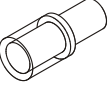
NO	Dim.			Col.-No	Qty
1	1668	274	16	1	1
2	1668	274	16	1	1
3	400	274	16	1	2
4	364	234	6	1	3
5	1680	378	3	1	1
6G	394	410	16	1	1
6D	394	410	16	1	1
7	925	362	4	1	1

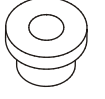

FLY TYP-42

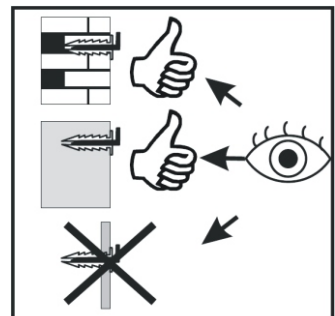
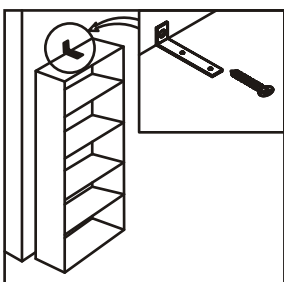
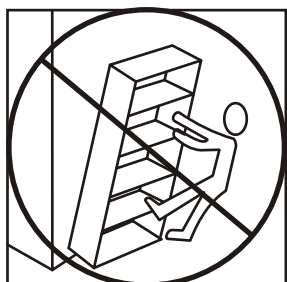
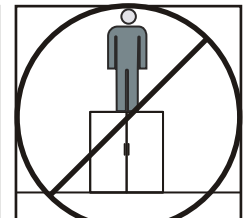
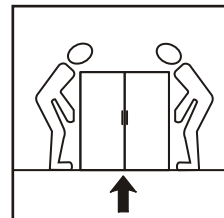
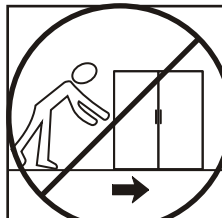
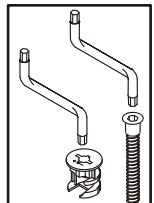
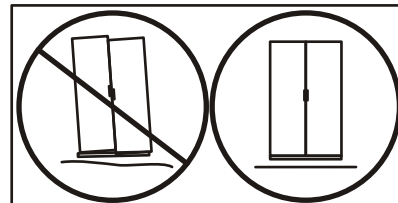
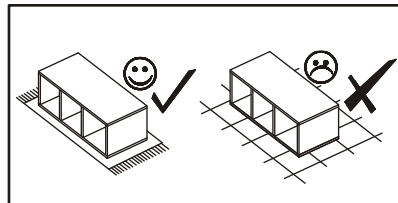
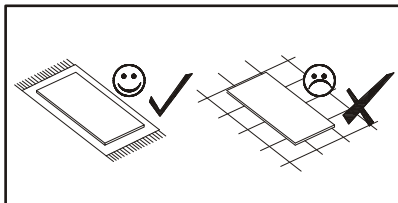
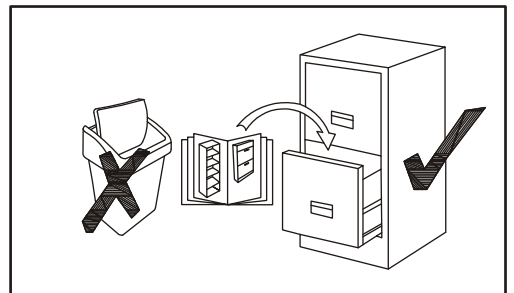
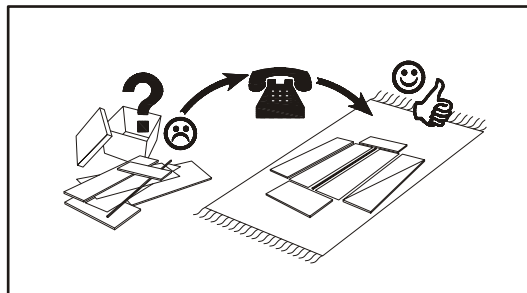
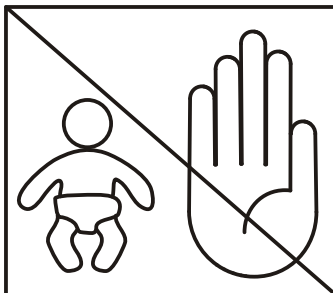
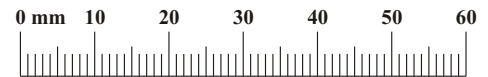
A1 x8  ø8x36	B4 x8 	B5 x8  ø15x12	G5 x8 	E1 x4  Ø26 H=0	E2 x4  H=0
ZR1 x2 	D6 x4  USØ3,5x30	S1 x12 	D10 x10  USØ3,5x13	KR2 x2 	G20 x12 
Z2 x8  Ø5	T1 x1 	G2 x1 	UP13 x6  UPØ3x16	P2 x6 	

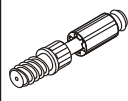
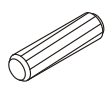

FLY TYP-42

1

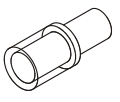

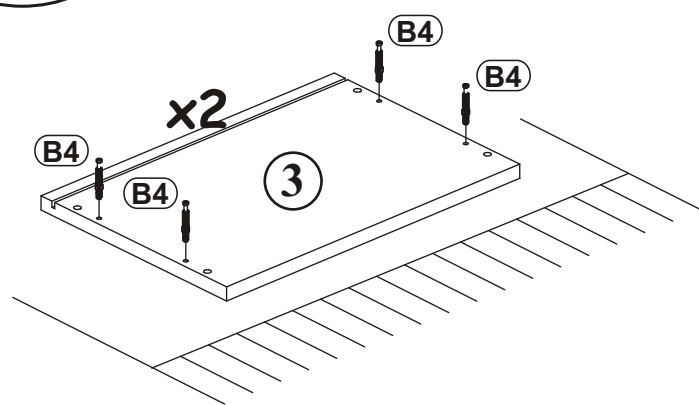
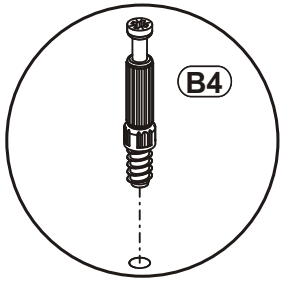
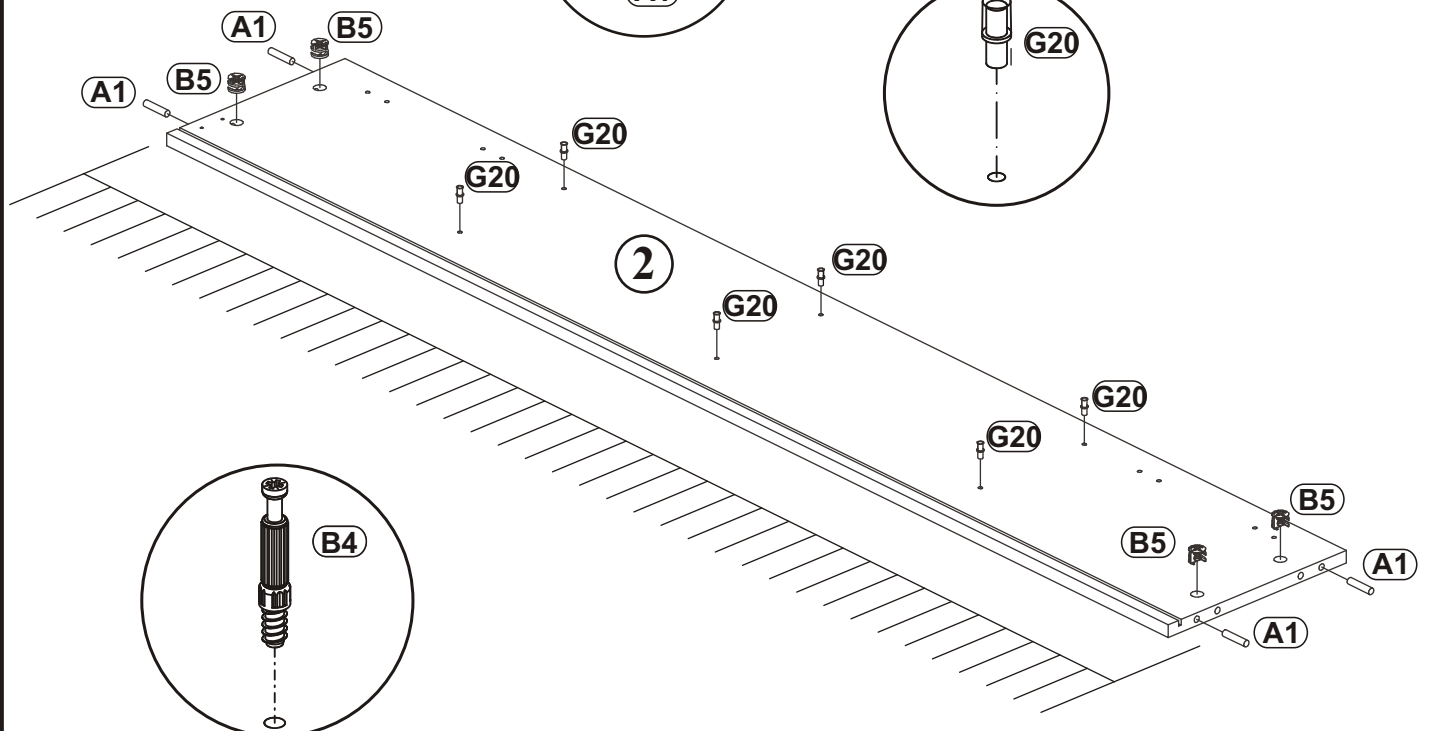
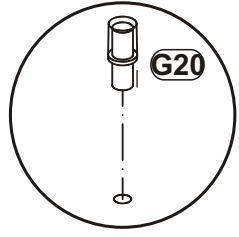
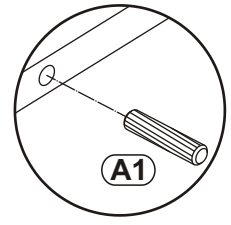
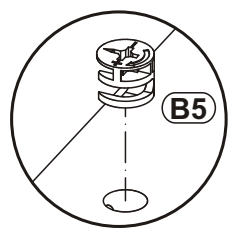
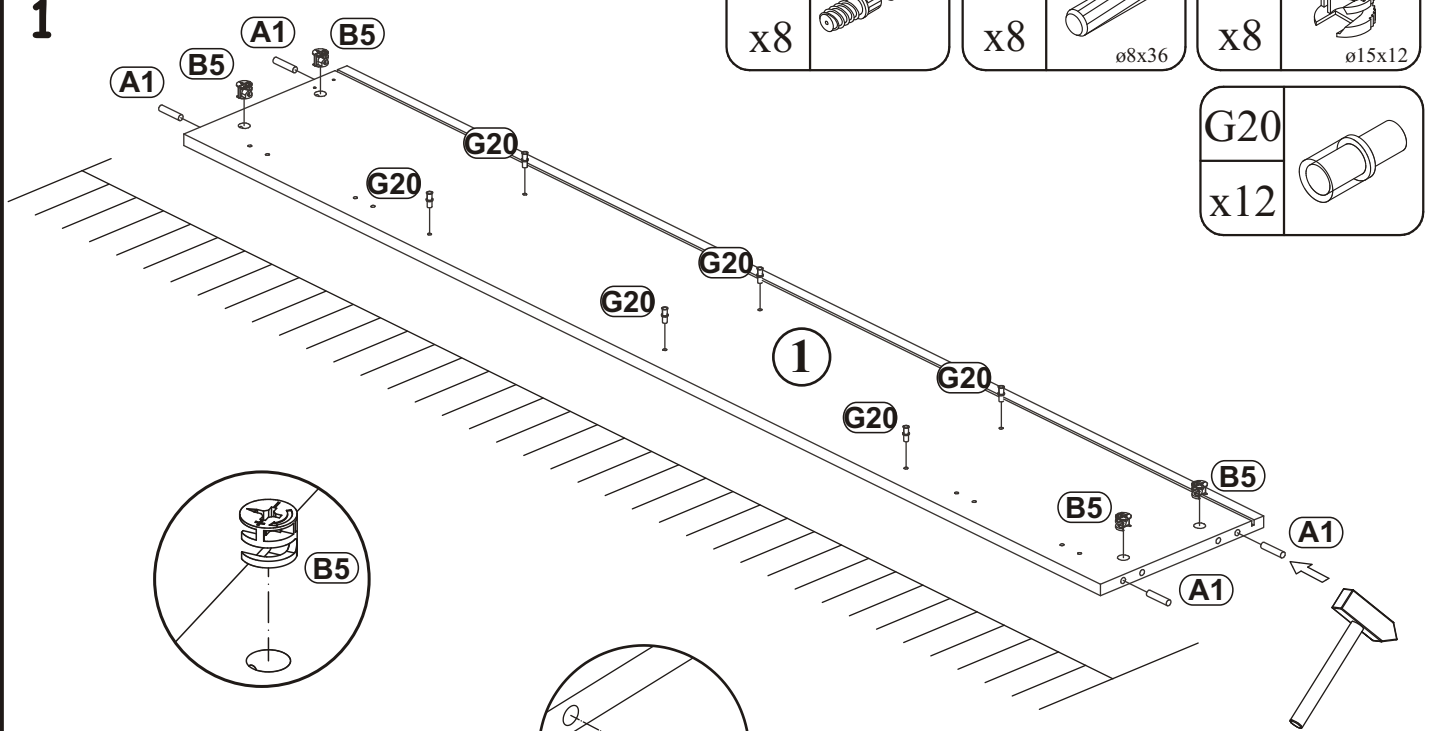
B4		A1		B5	
x8		x8	ø8x36	x8	ø15x12
		G20			
		x12			

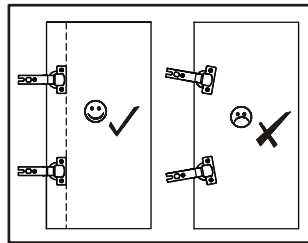
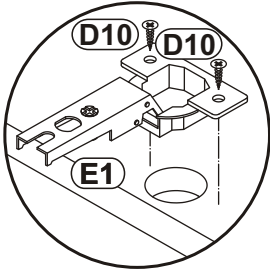

FLY TYP-42

2

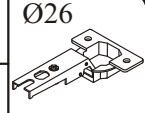

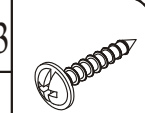
D10		E1	
x8	USØ3,5x13	x4	Ø26 H=0
P2		UP13	
x6		x6	UPØ3x16

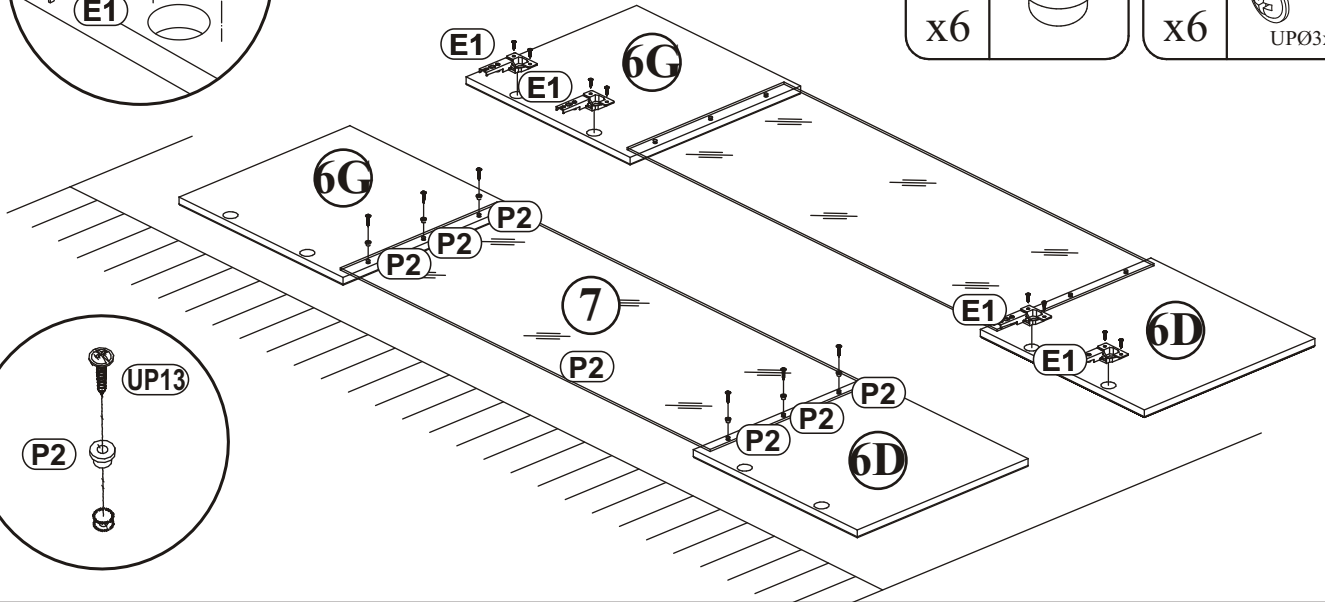
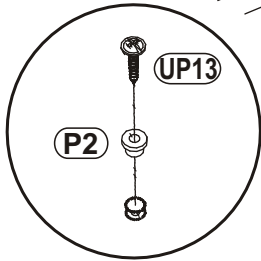

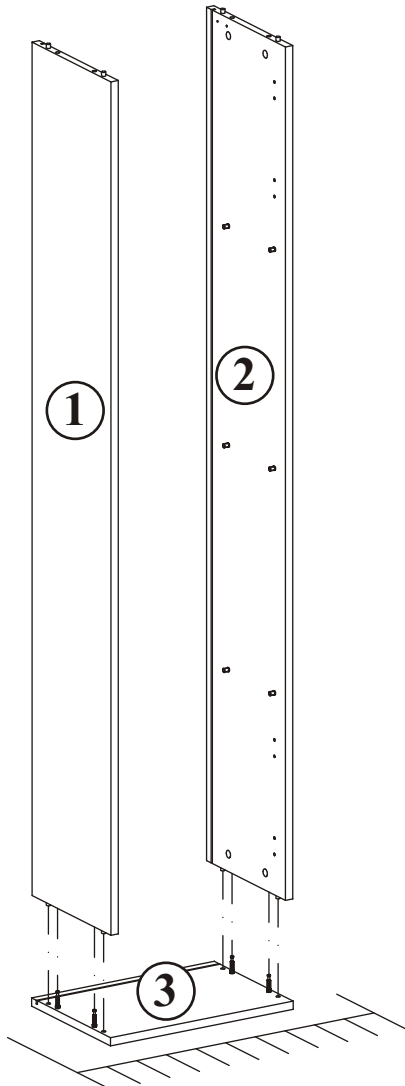

3

a)

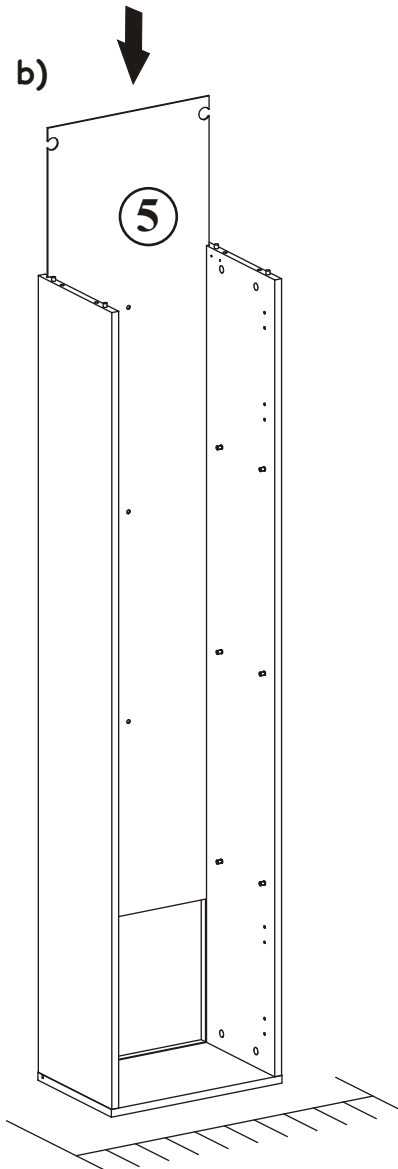

b)



G5	
x4	

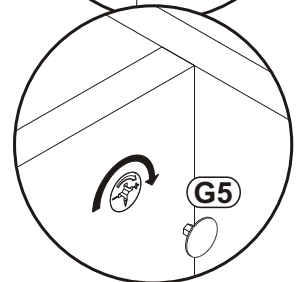
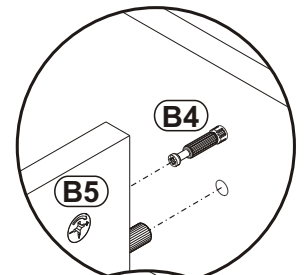

FLY TYP-42

4

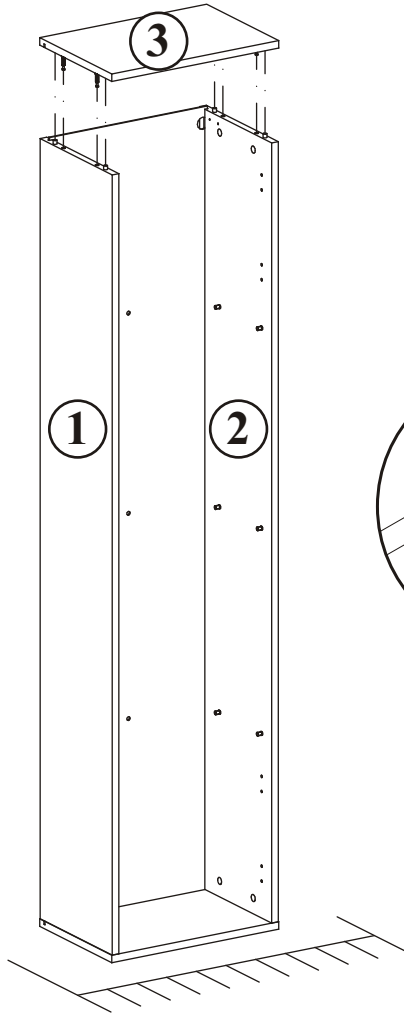

G5	
x4	

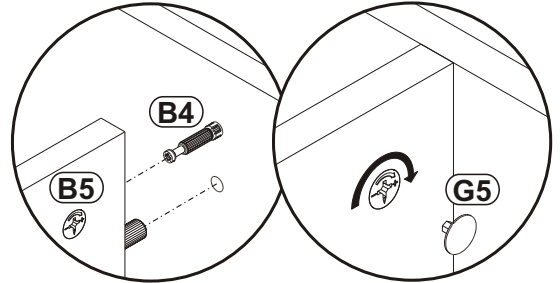

5

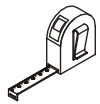

$X=Y$ 90°

Y

X

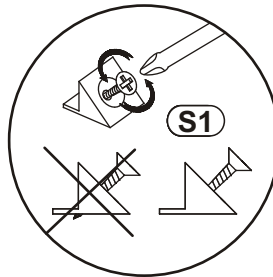
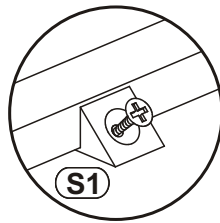

S1	
x12	

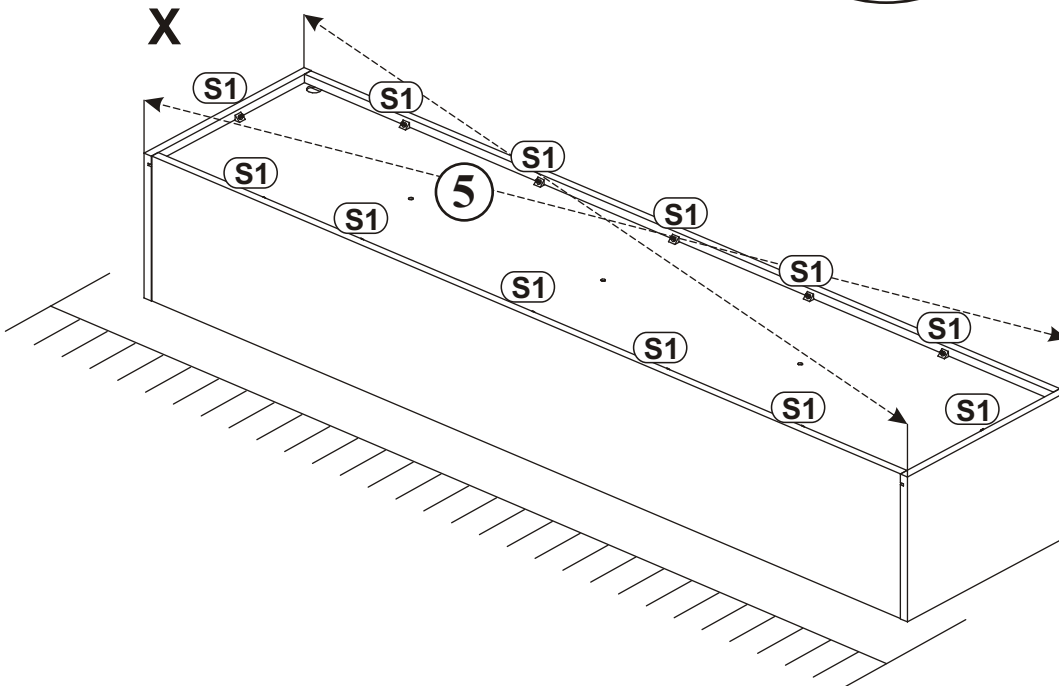

6

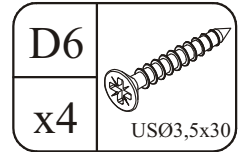
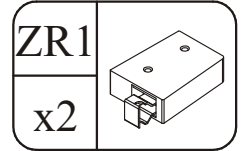
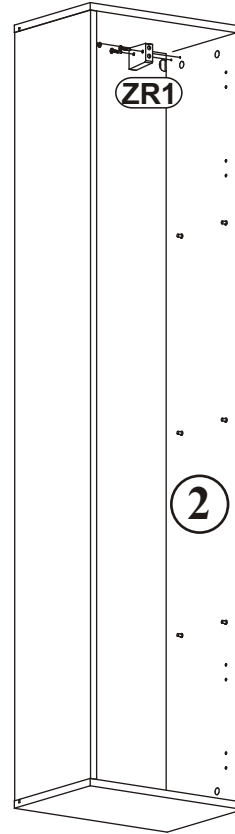
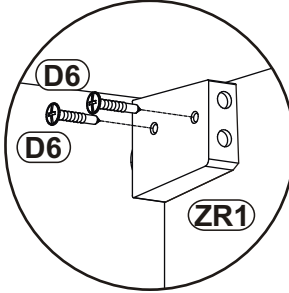
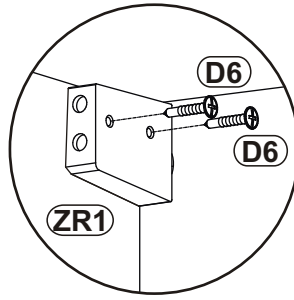
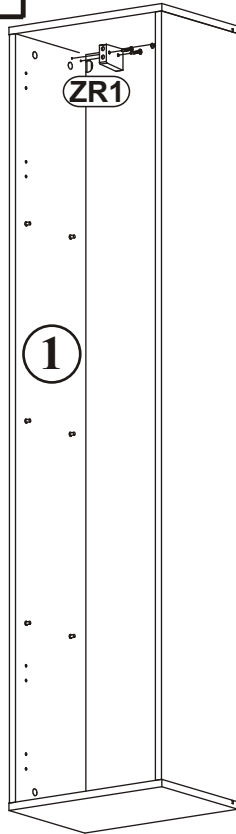

7

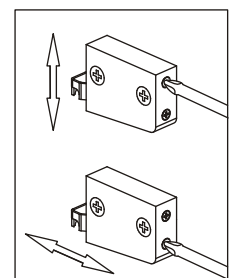
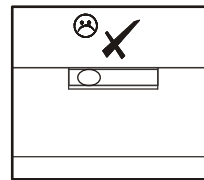
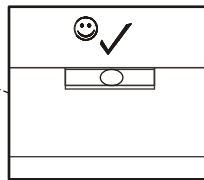
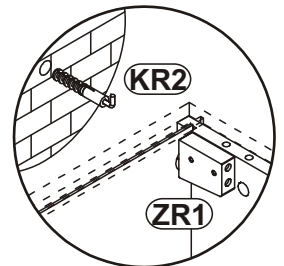
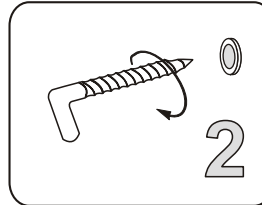
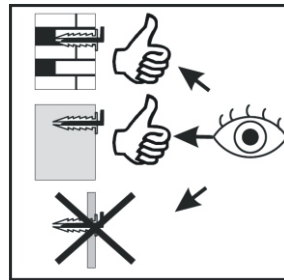
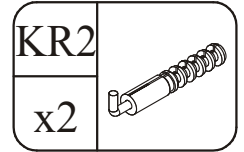
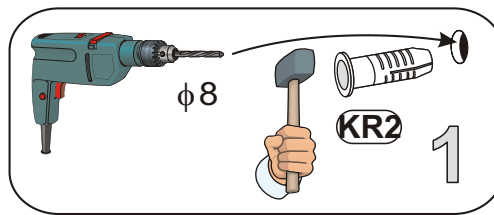
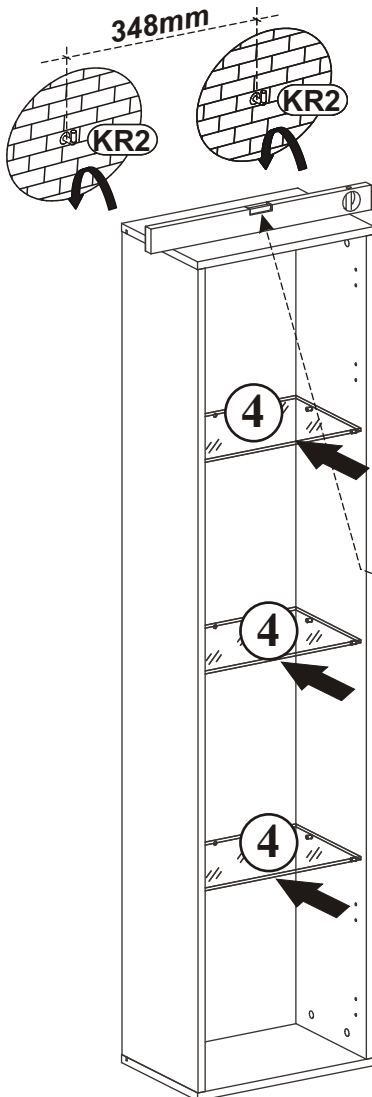

8 - 9

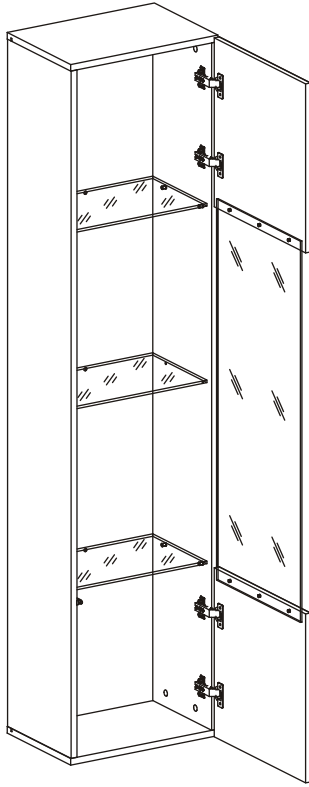

10 - 11

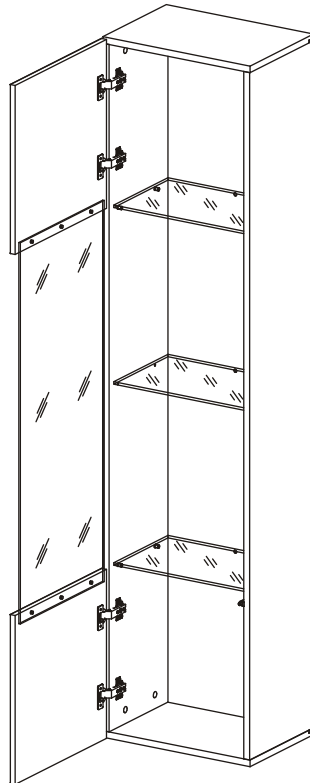

FLY TYP-42

8

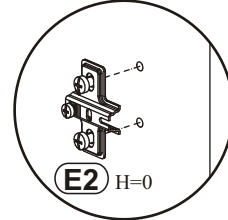
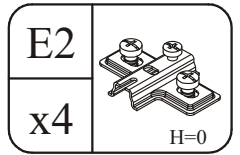
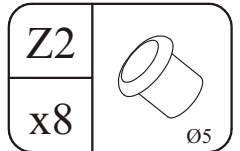
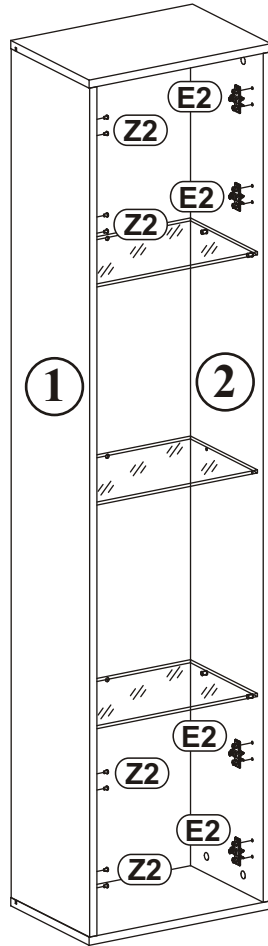
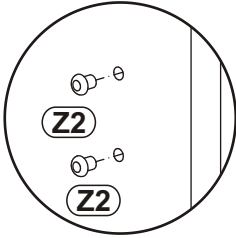
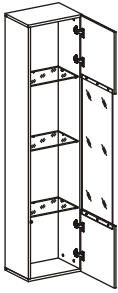

9

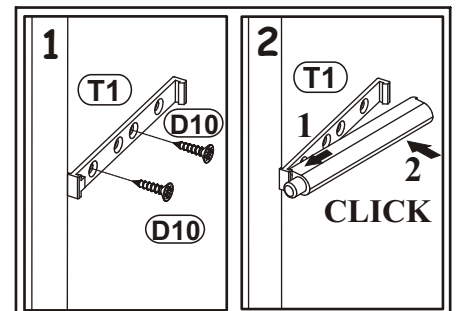
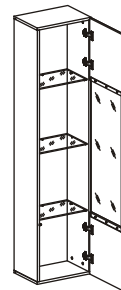
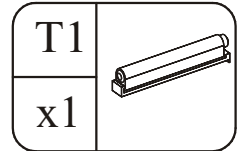
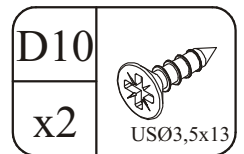
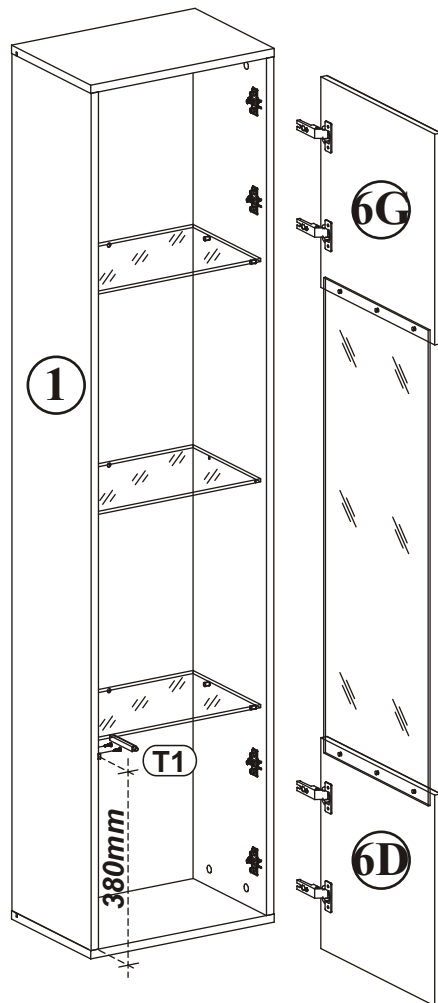
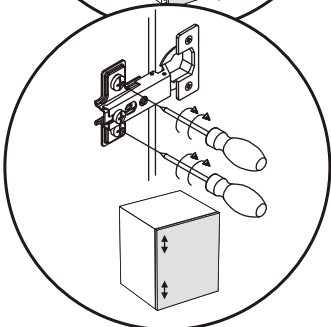
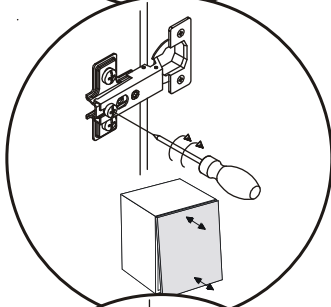
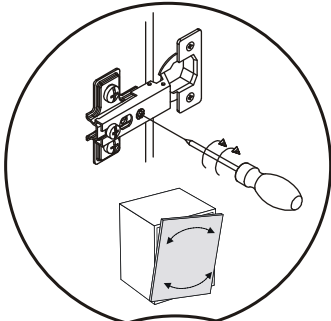

FLY TYP-42

10

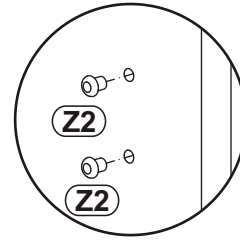
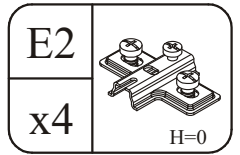
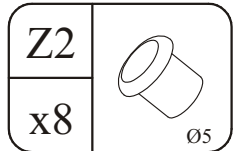
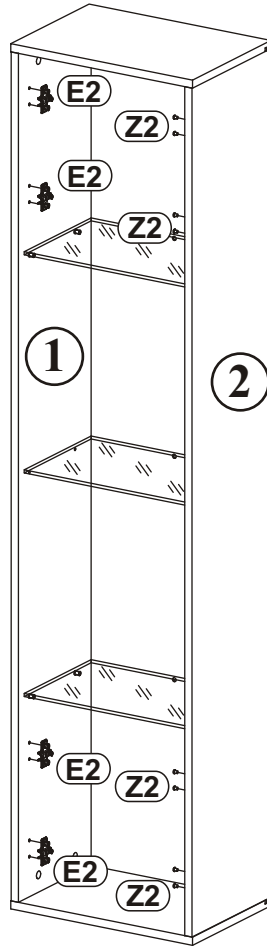
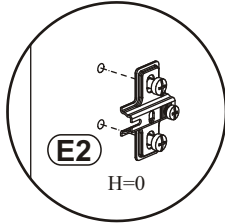
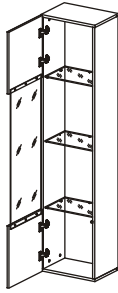

11

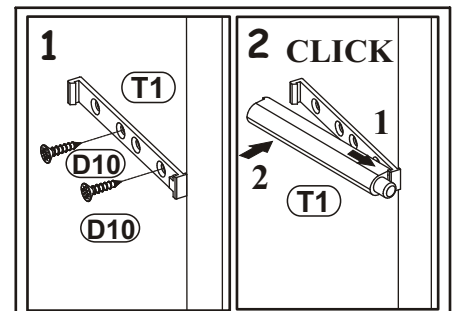
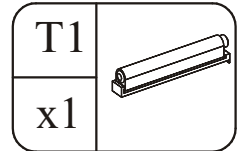
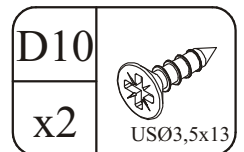
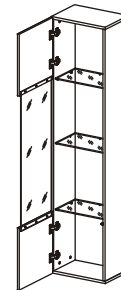
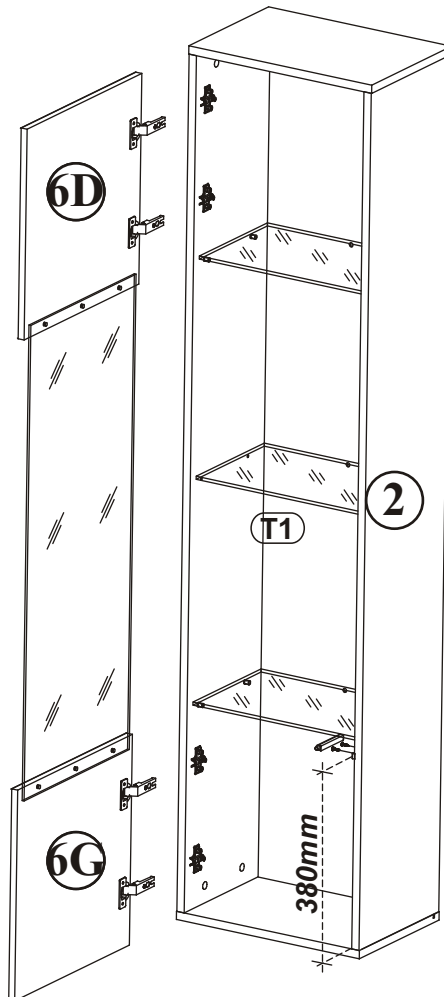
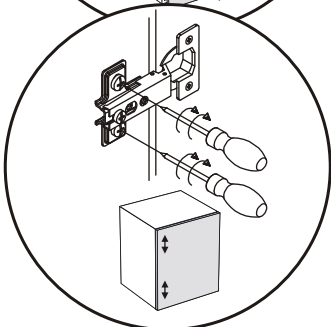
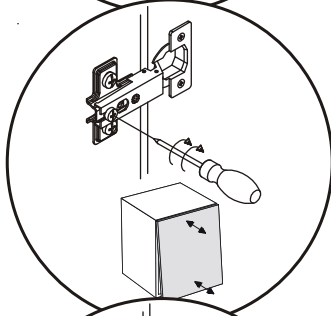
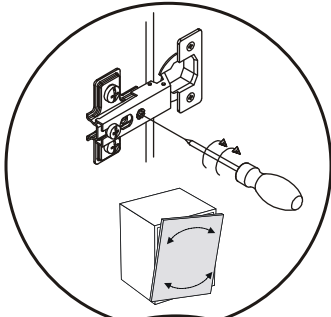



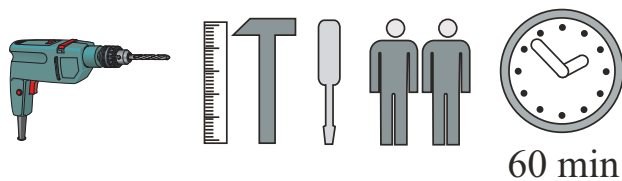
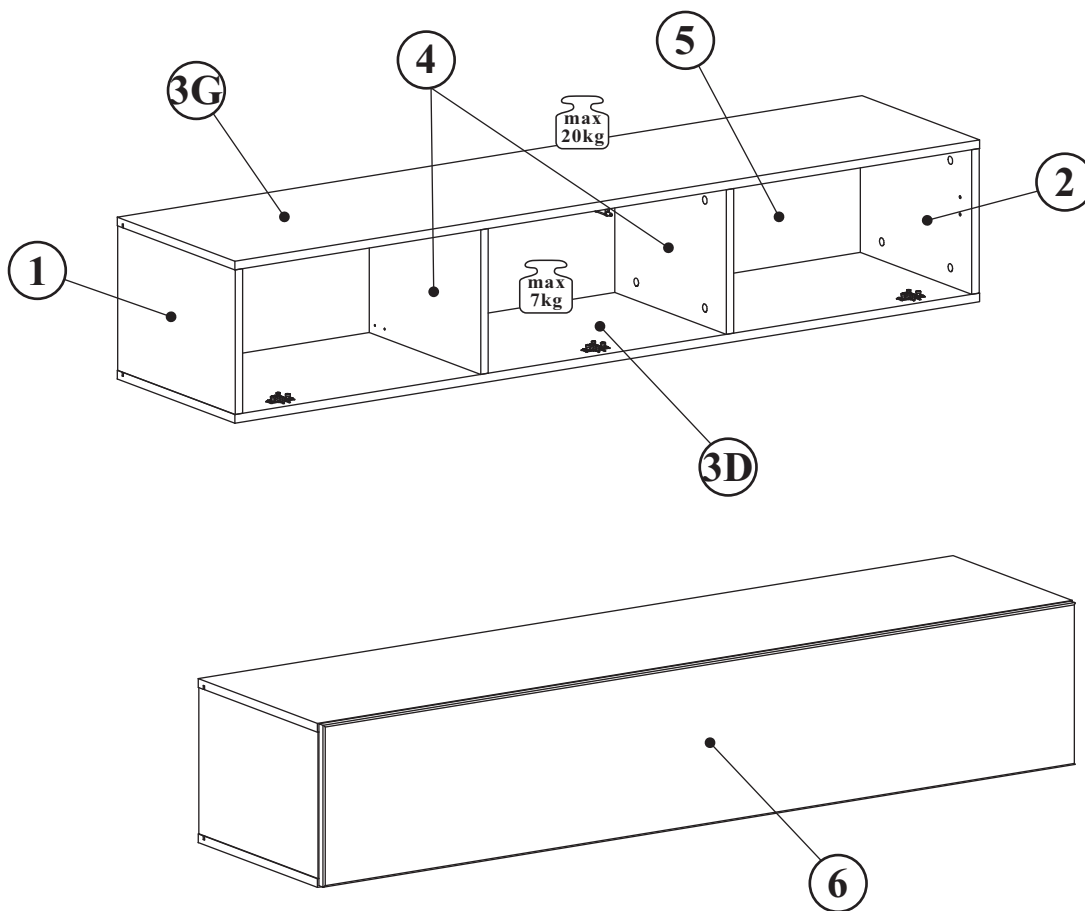
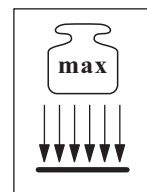





FLY TYP-30

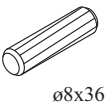
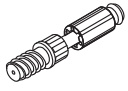

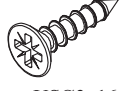
60 min

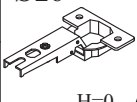
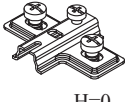
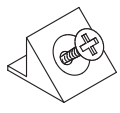
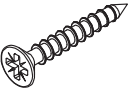
NO	Dim.			Col.-No	Qty
1	268	384	16	1	1
2	268	384	16	1	1
3D/G	1602	384	16	1	2
4	268	364	16	1	2
5	1580	280	3	1	1
6	1596	296	16	1	1

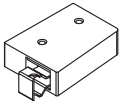

FLY TYP-30

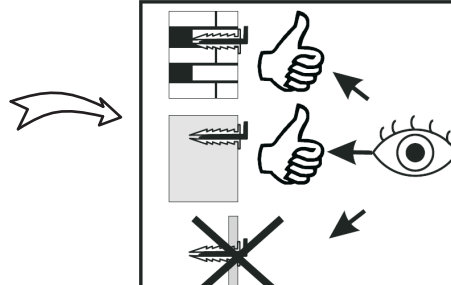
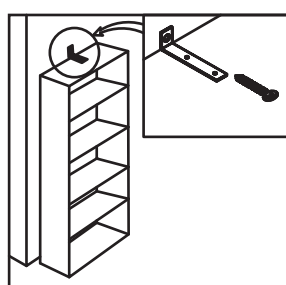
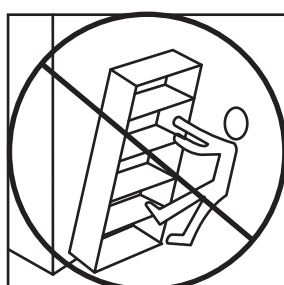
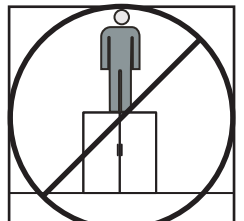
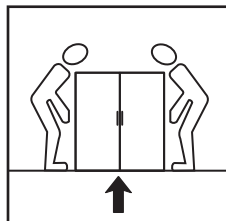
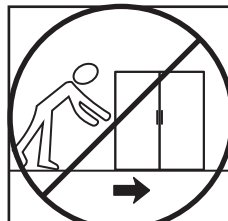
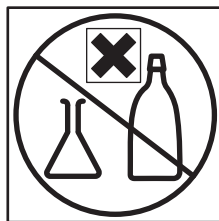
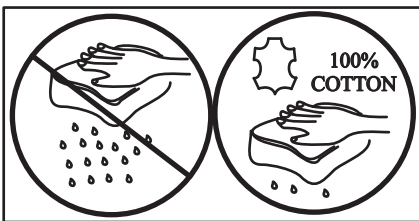
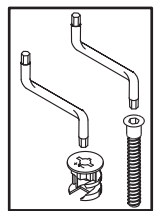
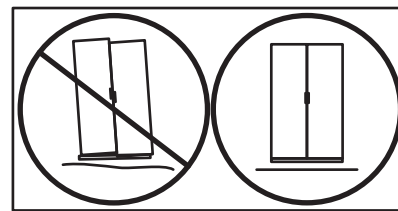
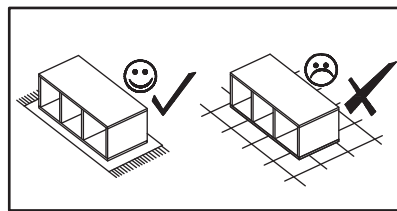
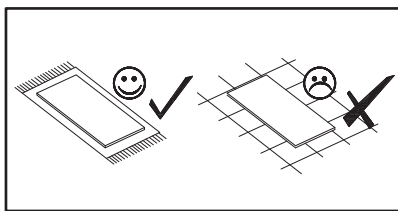
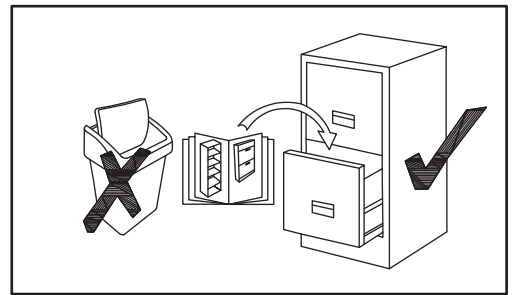
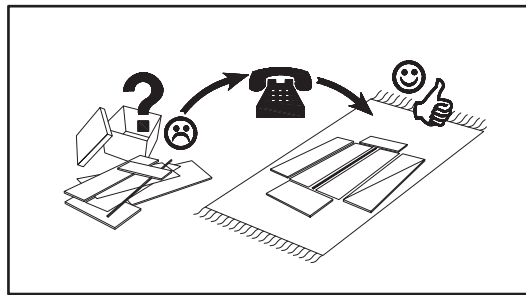
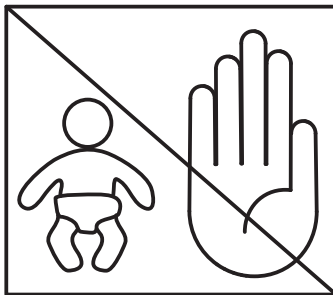
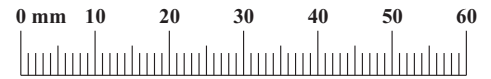
A1 x16  ø8x36	B4 x16 	B5 x16  ø15x12	G5 x16 	D7 x6  USØ3x16	G2 x1 
E1 x3 Ø26  H=0	E2 x3  H=0	S1 x12 	D6 x8  USØ3,5x30	D10 x12  USØ3,5x13	G21 x2 
ZR1 x4 	KR2 x4 	T1 x1 			

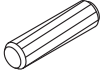

FLY TYP-30

1

A1		B5	
x16	ø8x36	x16	ø15x12

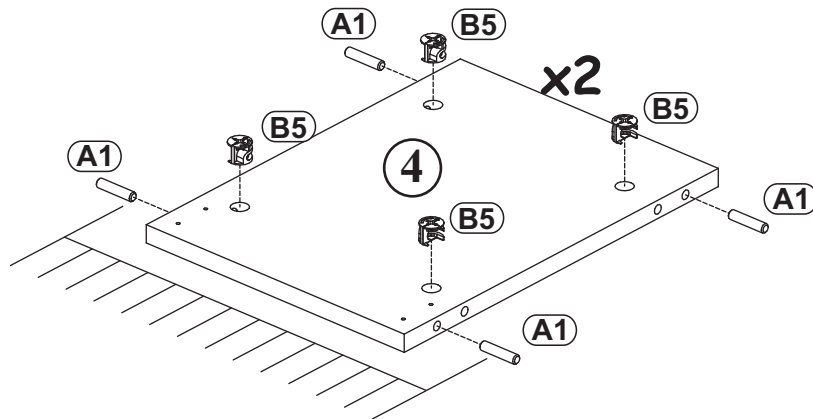
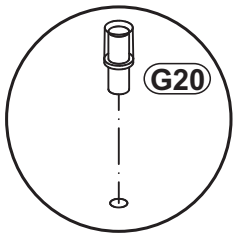
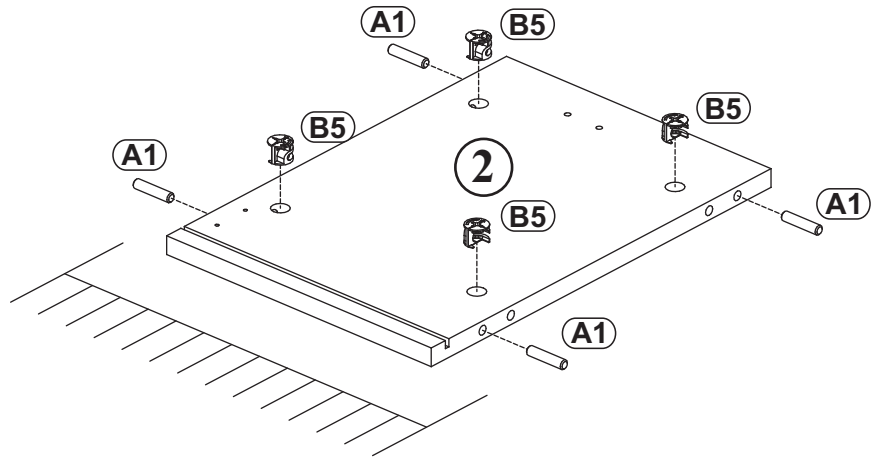
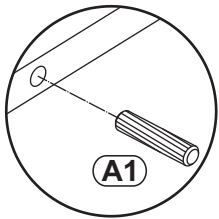
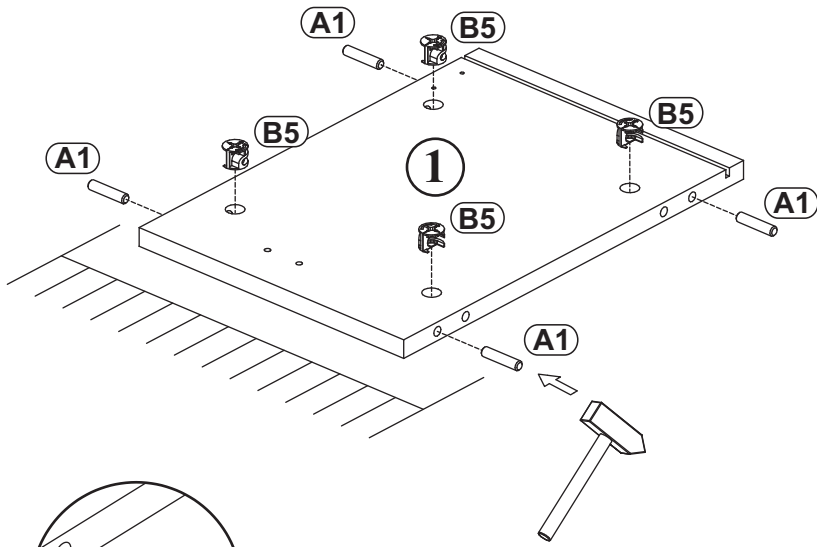

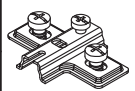
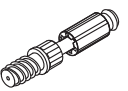

FLY TYP-30

2

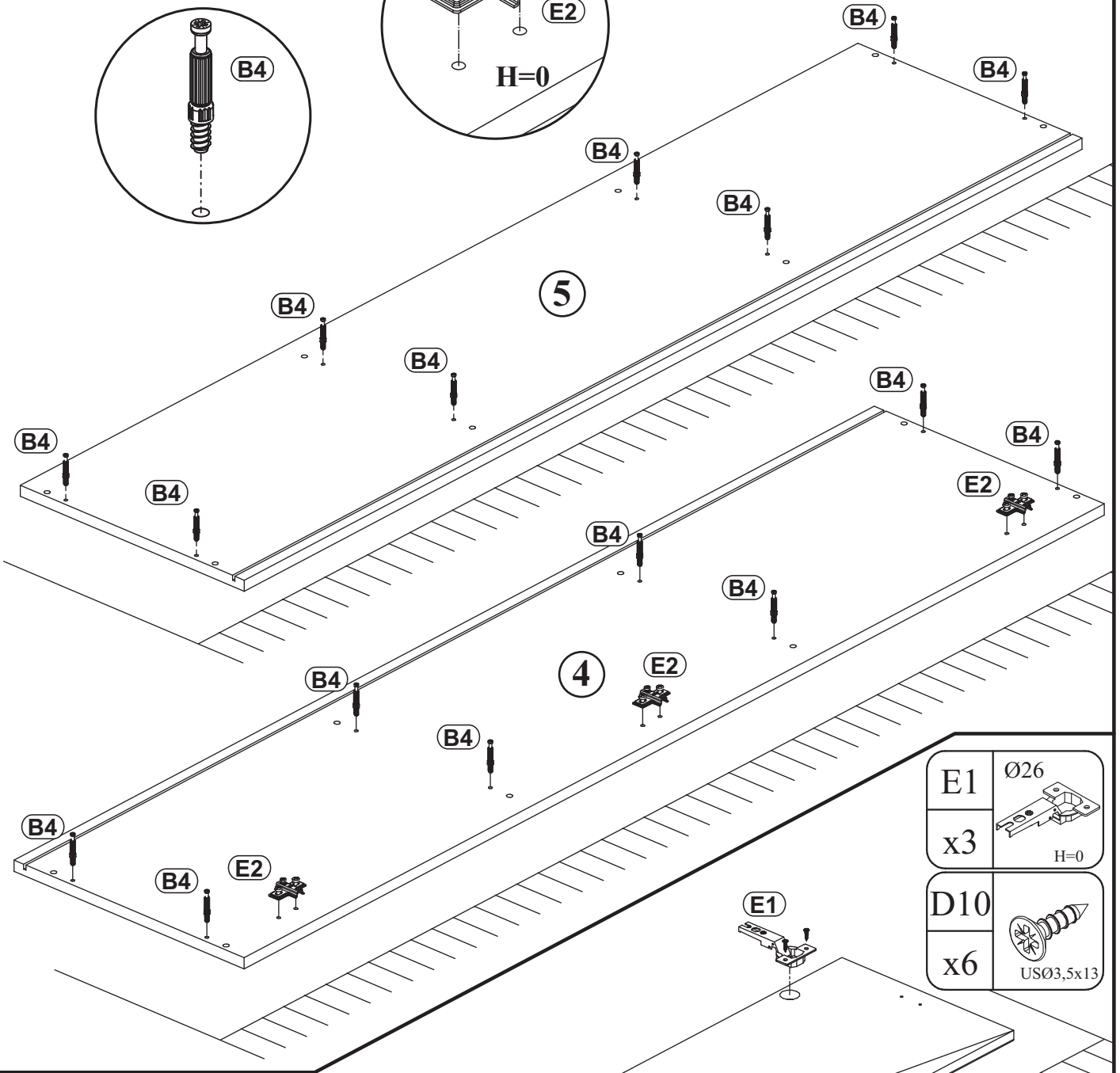
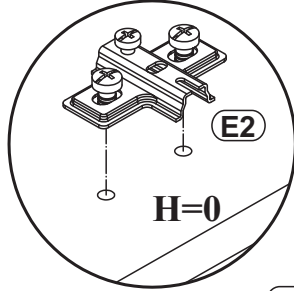
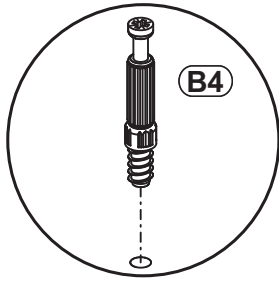
E2		B4	
x3	H=0	x16	

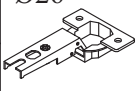

3

E1		Ø26
x3	H=0	
D10		USØ3,5x13
x6		

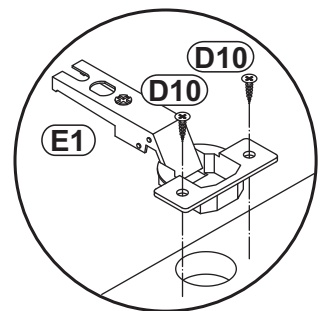
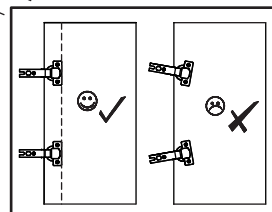
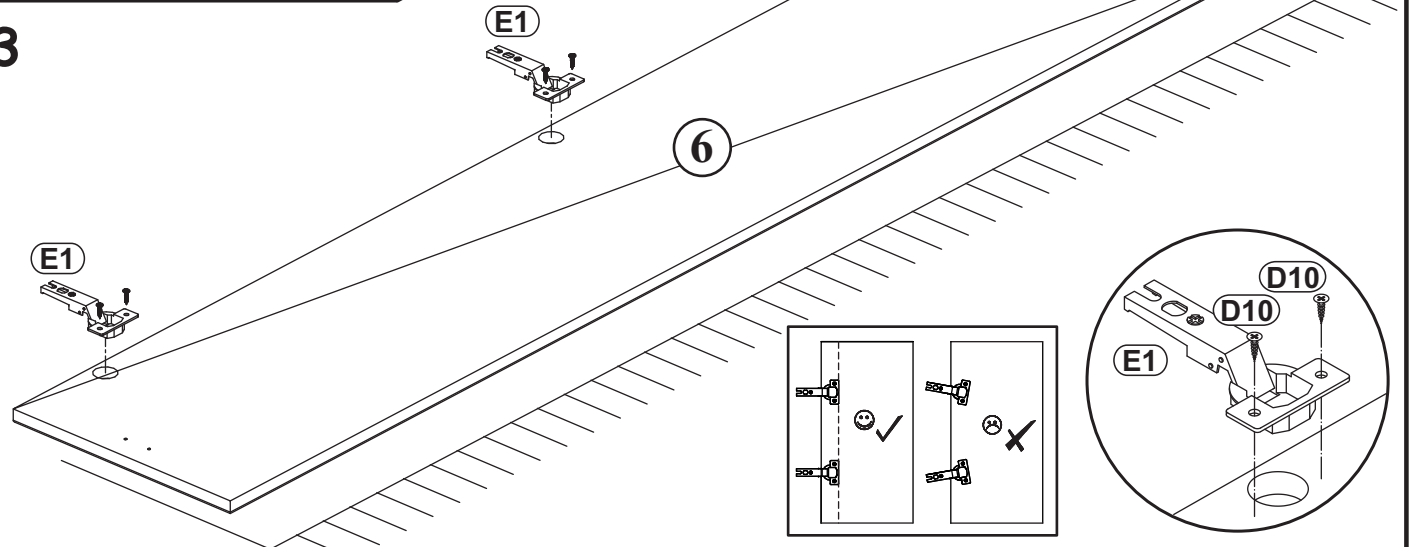

G5	
x16	

4

a)

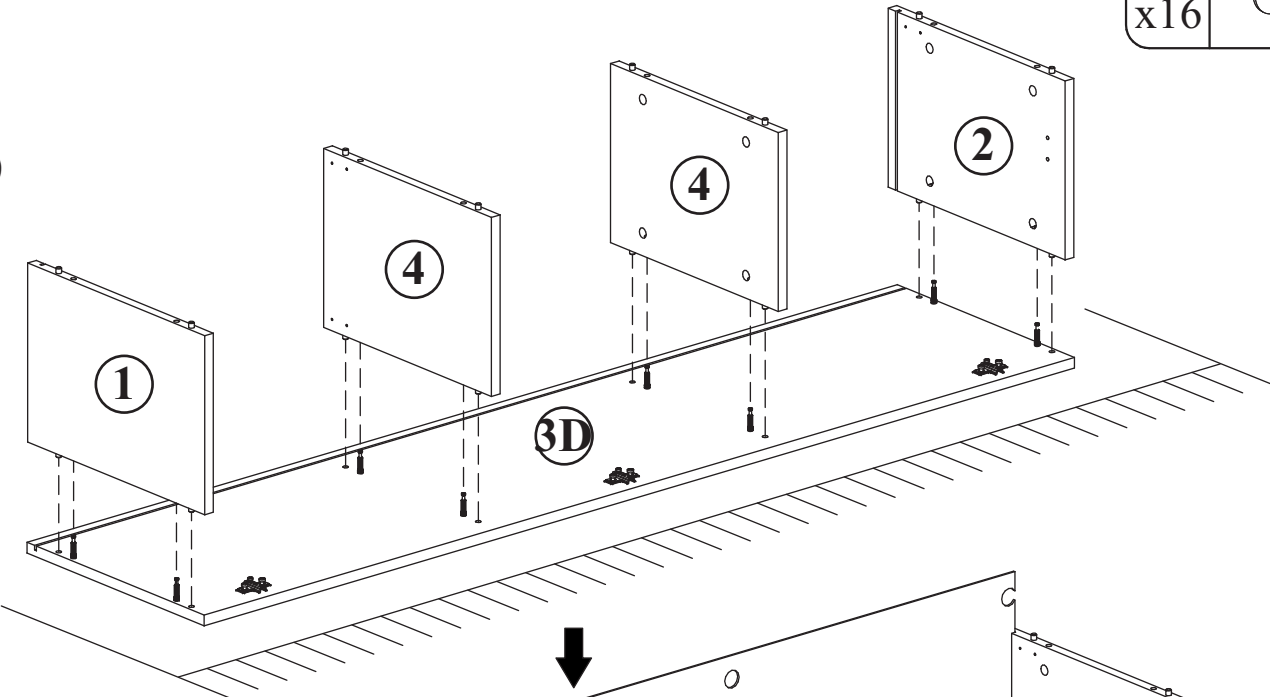

b)

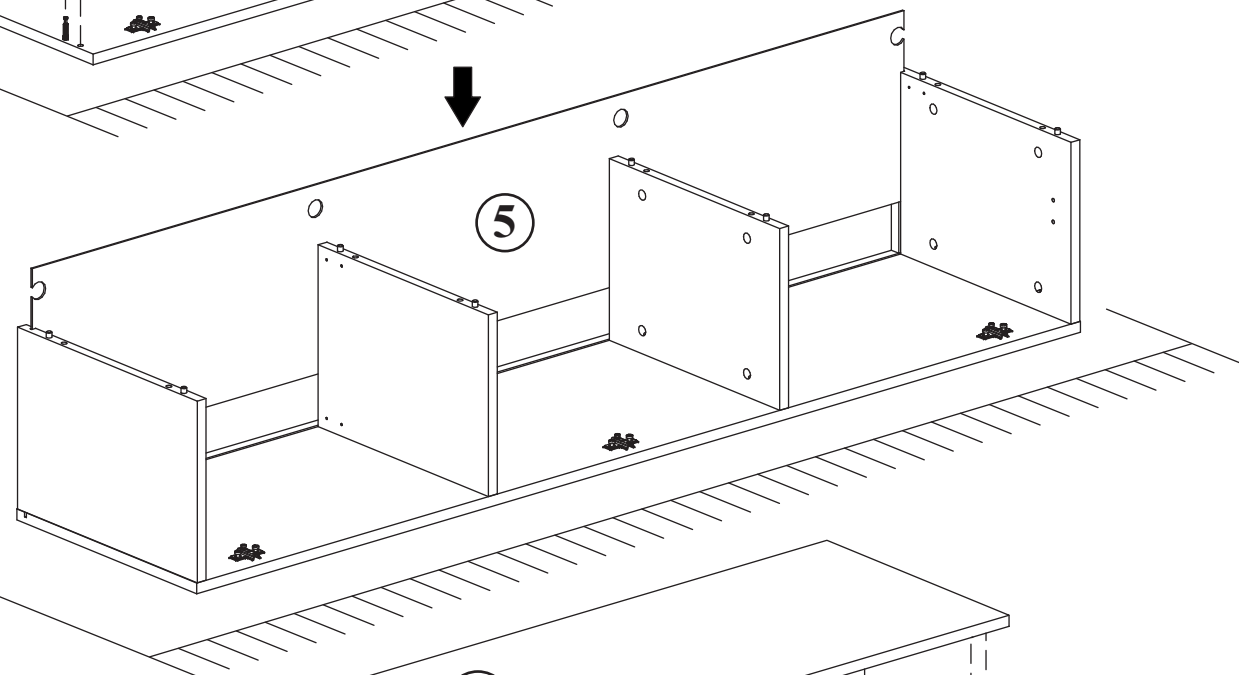

c)

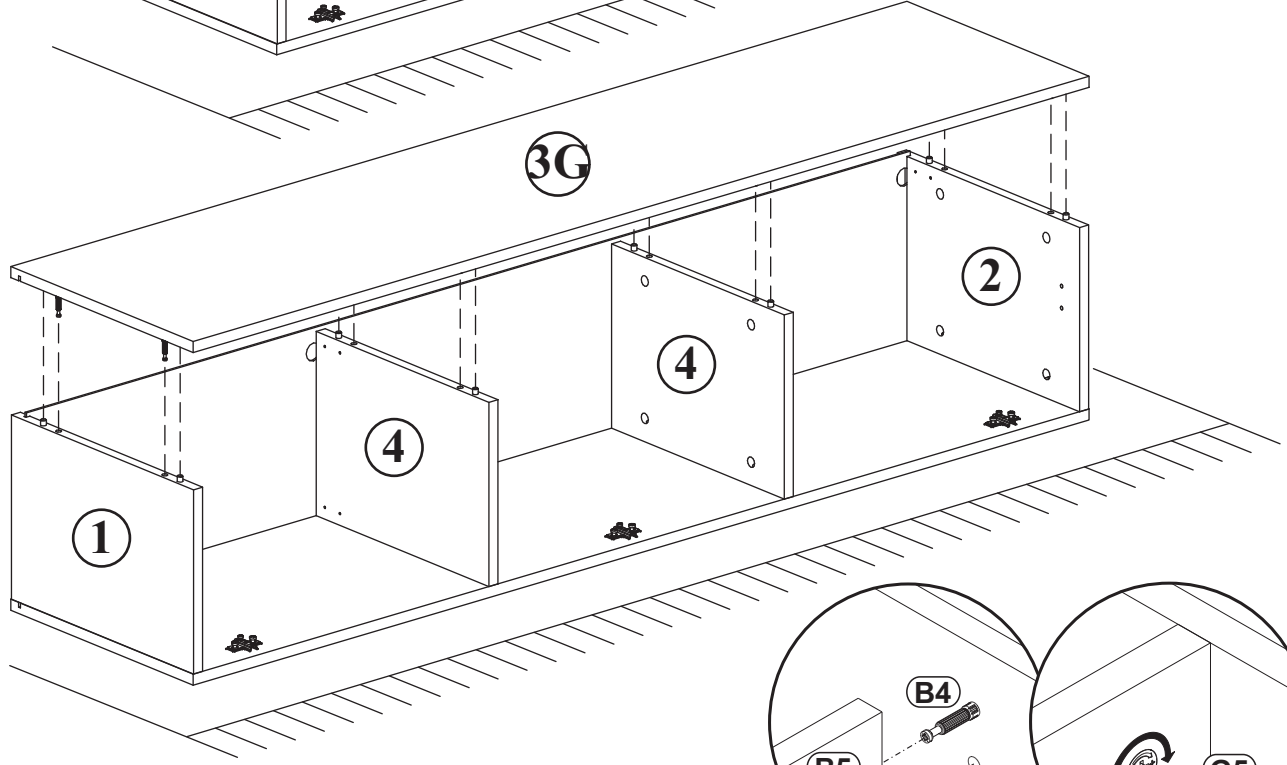

B4

B5

G5

FLY TYP-30

5

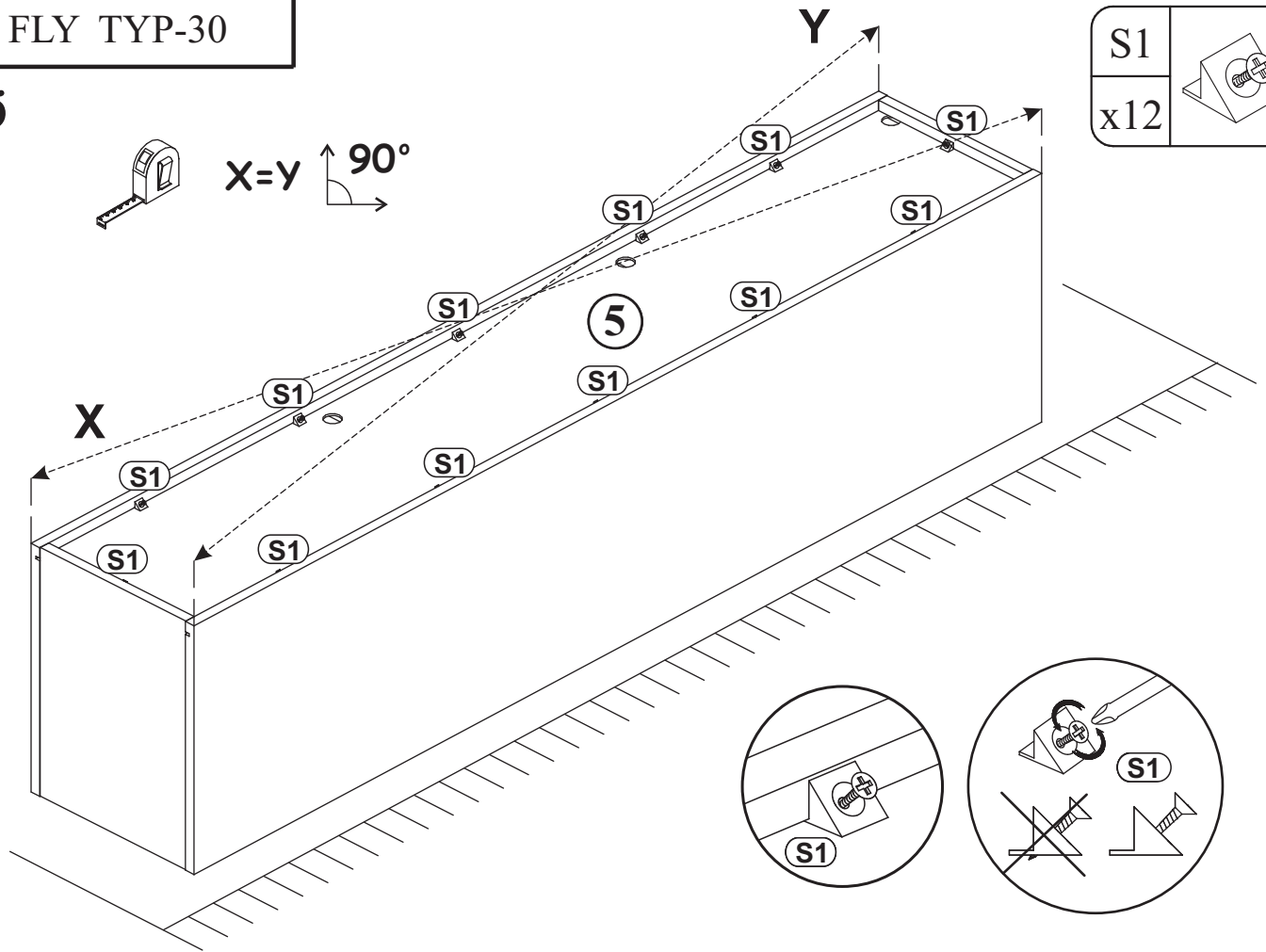

S1	
x12	

6

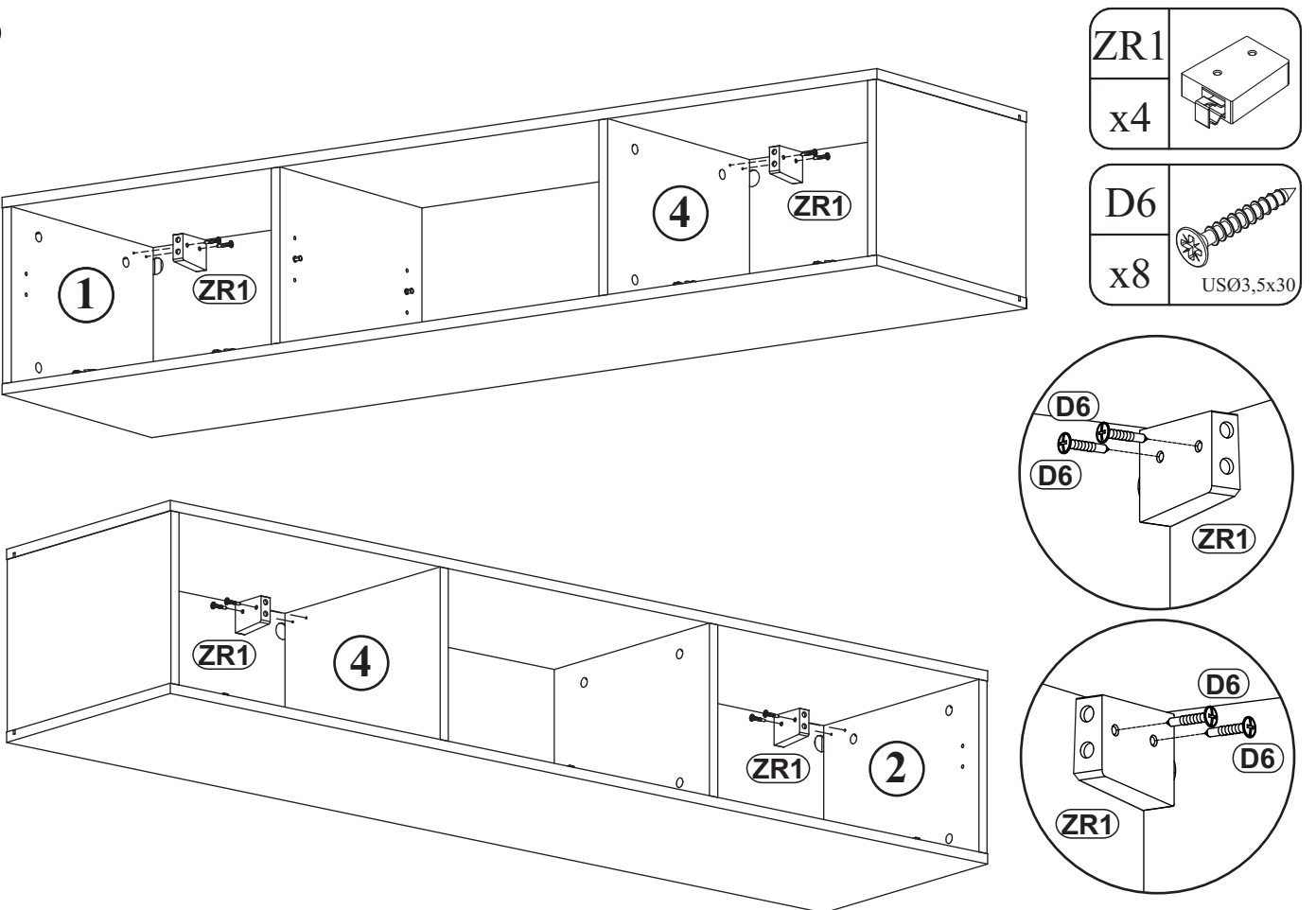

ZR1	
x4	

D6	
x8	USØ3,5x30

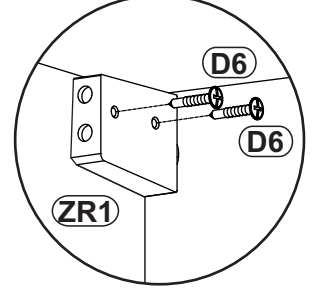
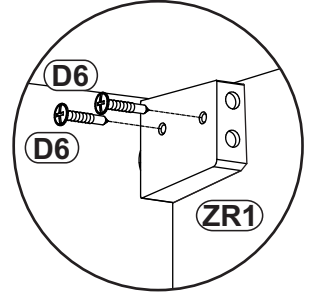

FLY TYP-30

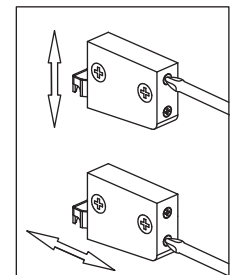
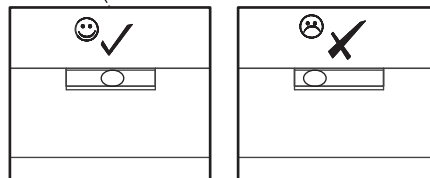
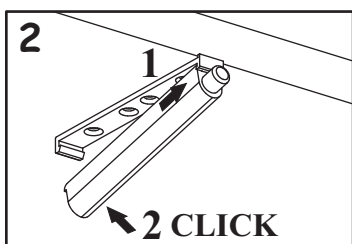
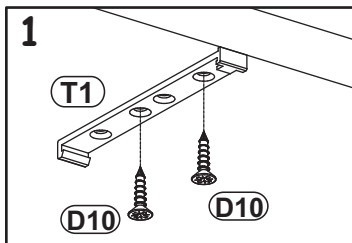
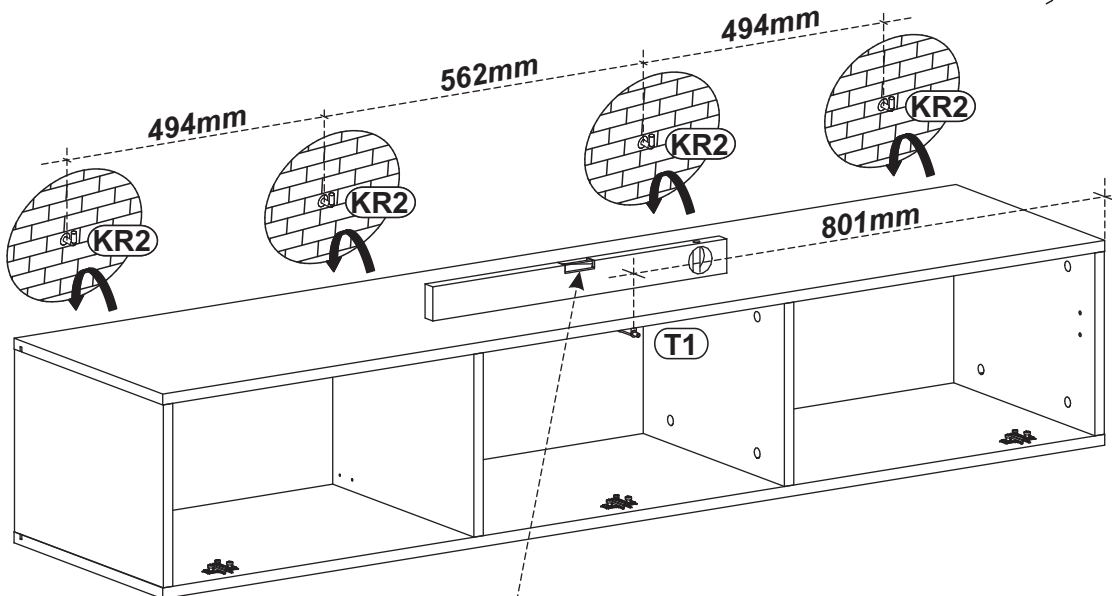
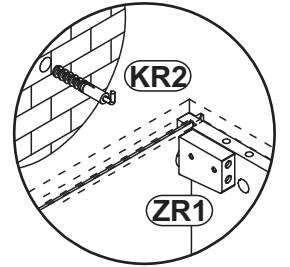
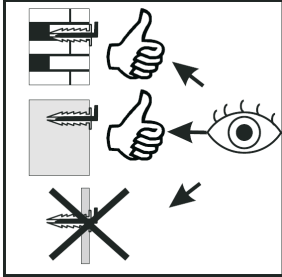
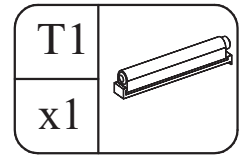
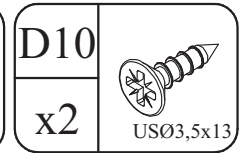
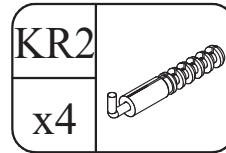
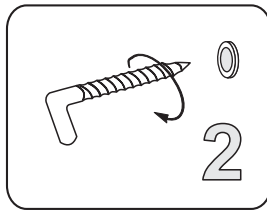
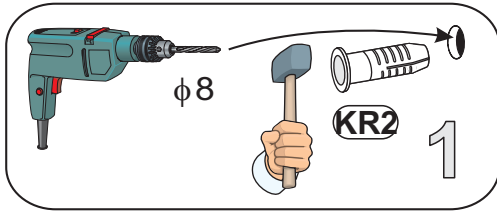

7

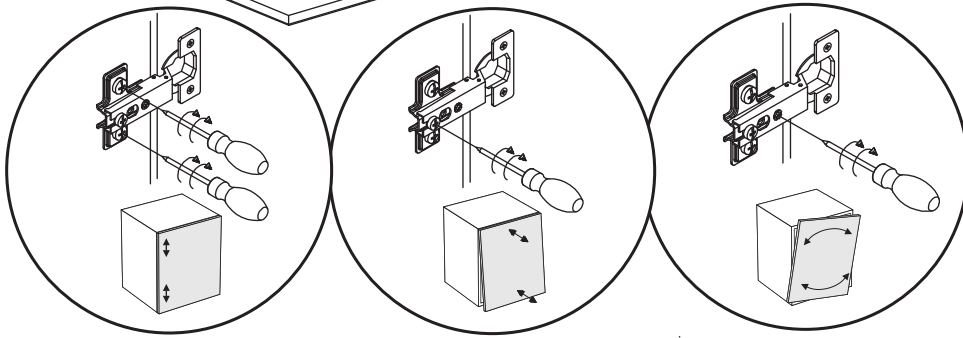
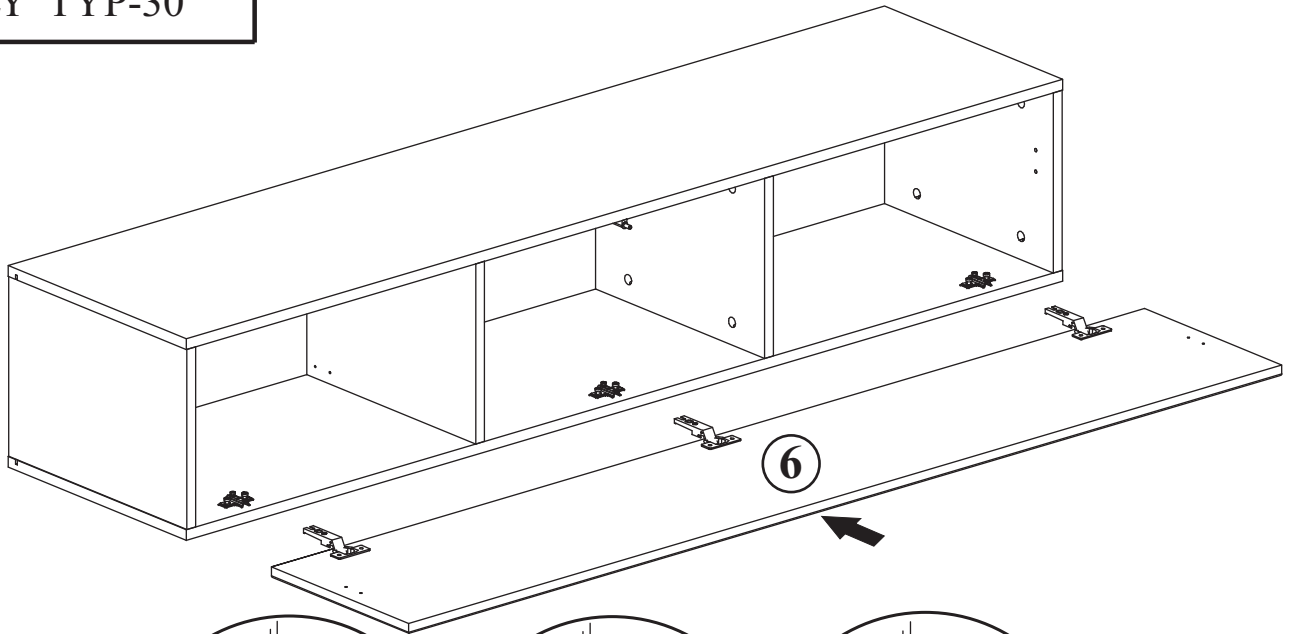

8



9

D10 x4	 USØ3,5x13	G21 x2	
		D7 x6	 USØ3x16

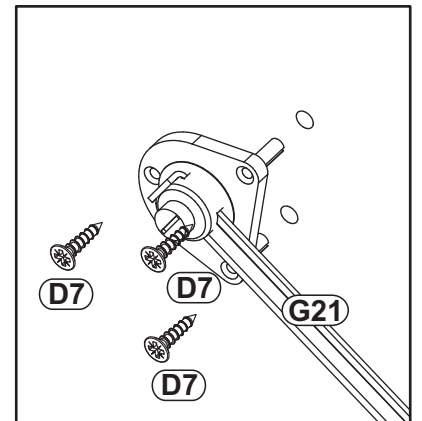
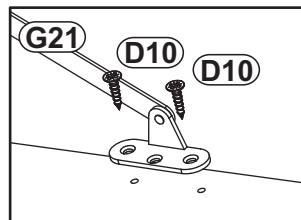
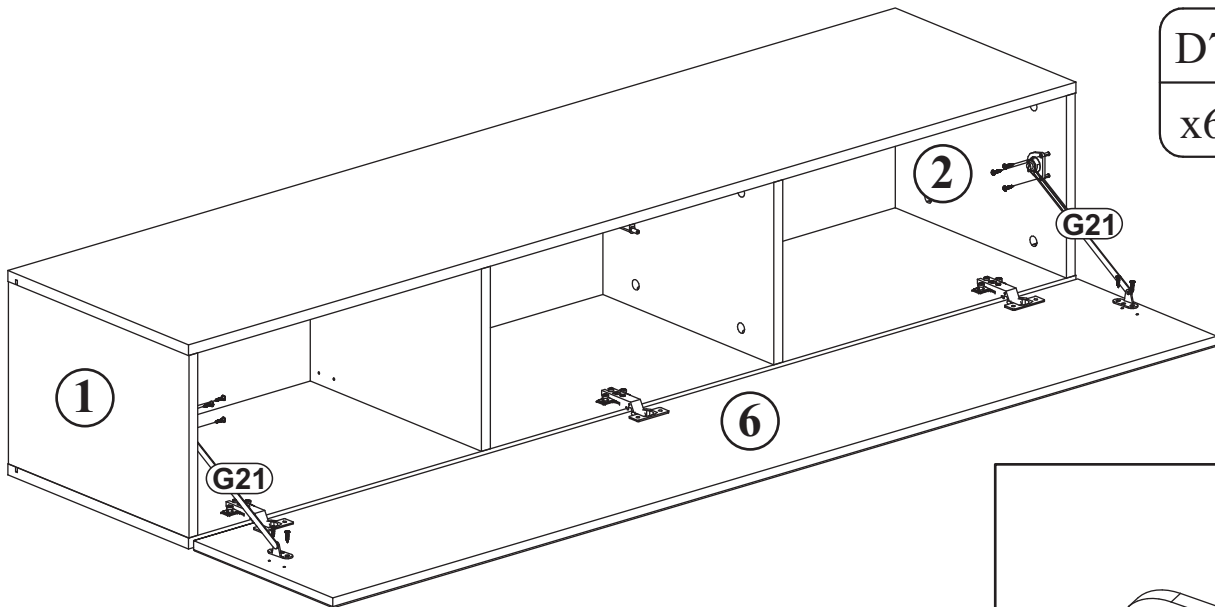



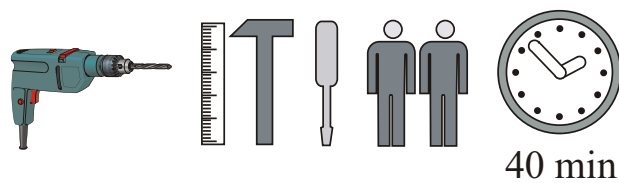
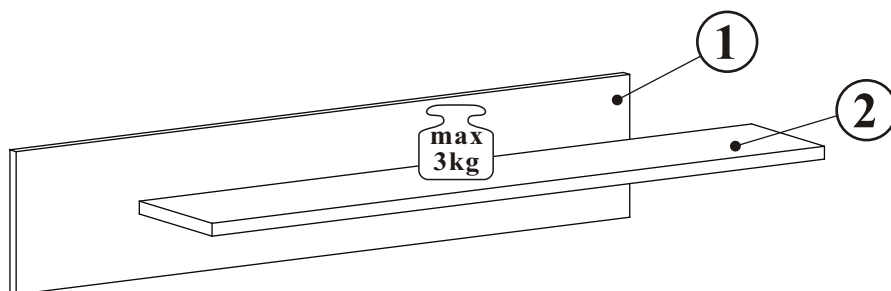
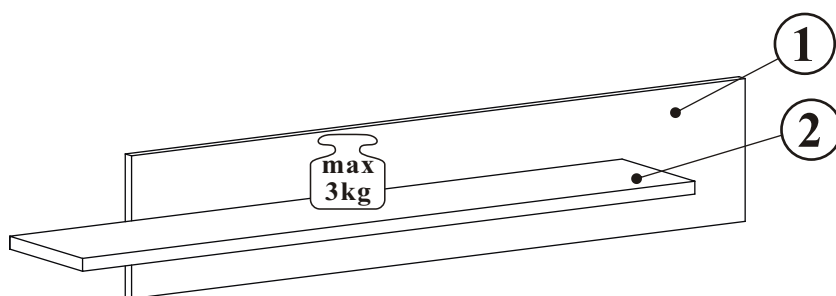
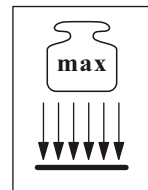
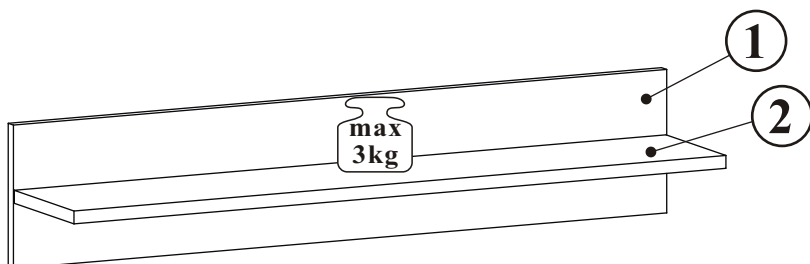



GALINO 23_MX

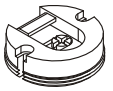

NO	Dim.		Col.-No	Qty
1	1002	200	1	2
2	1000	185	1	2

GALINO 23_MX

ZM1 x4		D20 x8	 ESØ6x9,5	B11 x12	 Ø7x50	G4 x12		KR2 x4		G2 x1	
-----------	---	-----------	---	------------	--	-----------	---	-----------	---	----------	---

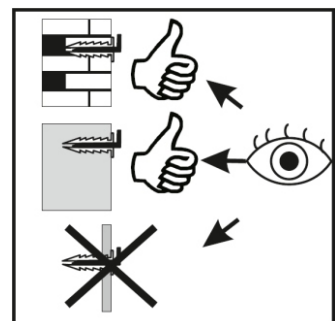
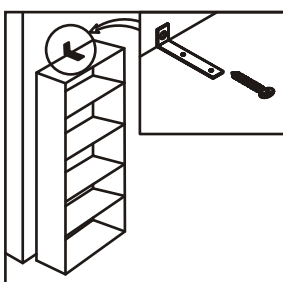
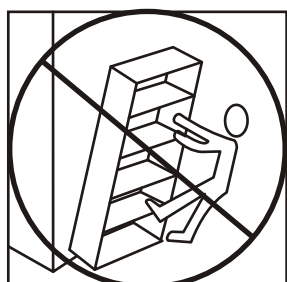
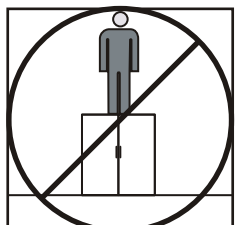
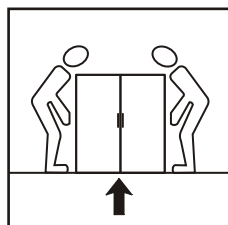
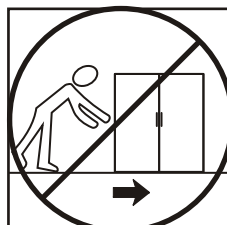
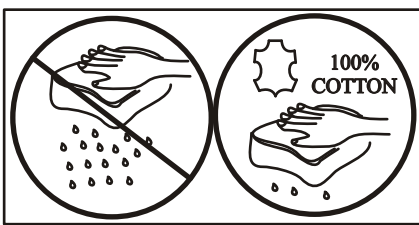
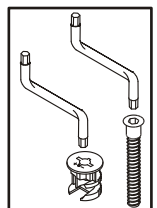
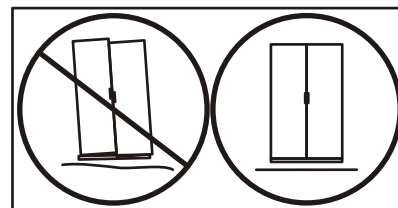
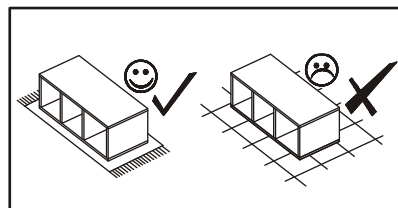
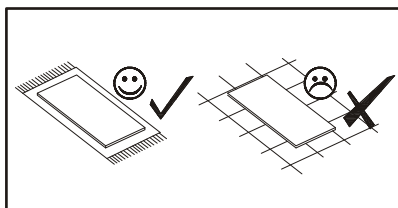
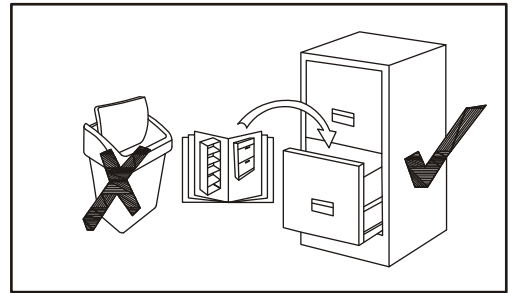
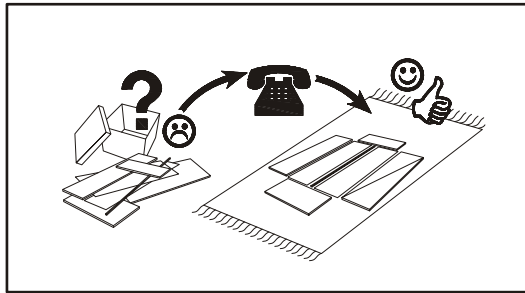
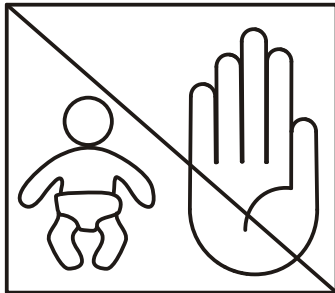
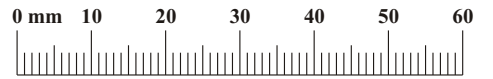

1-3

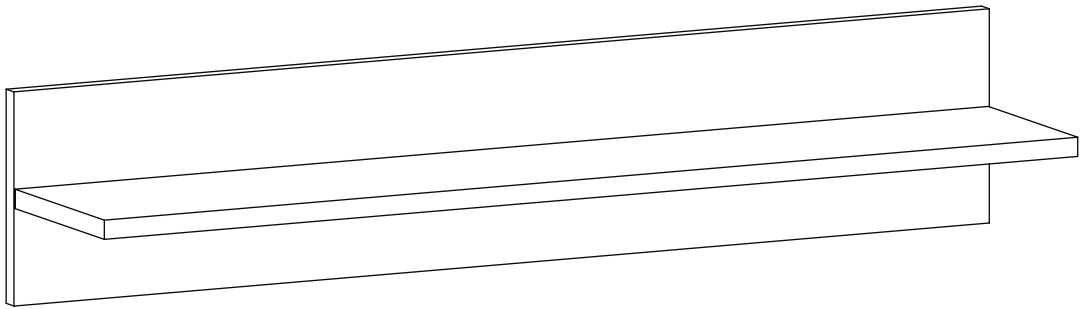

4-6

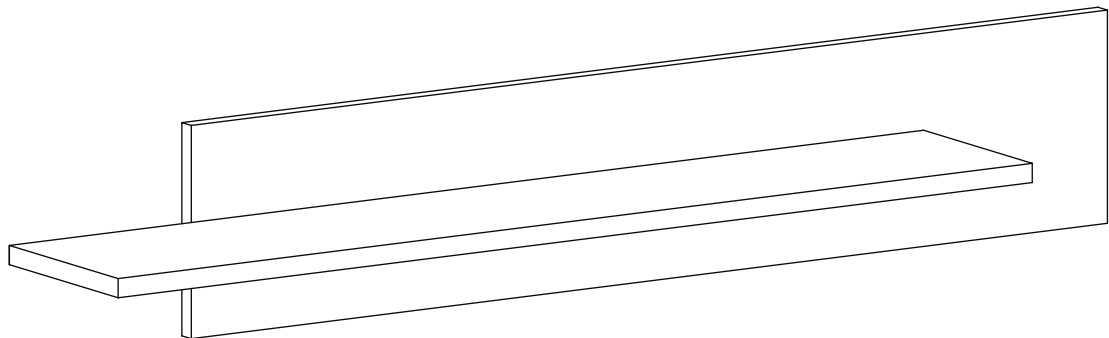

7-9

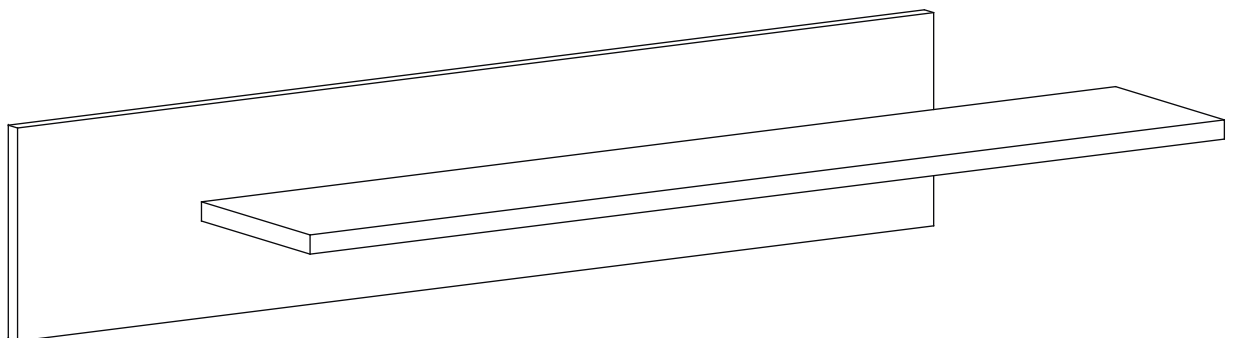

GALINO 23_MX

1

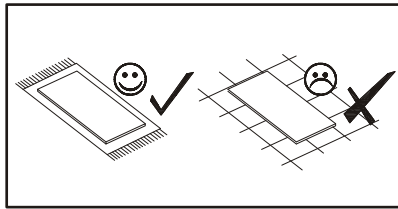

ZM1
x4

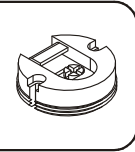

D20
x8

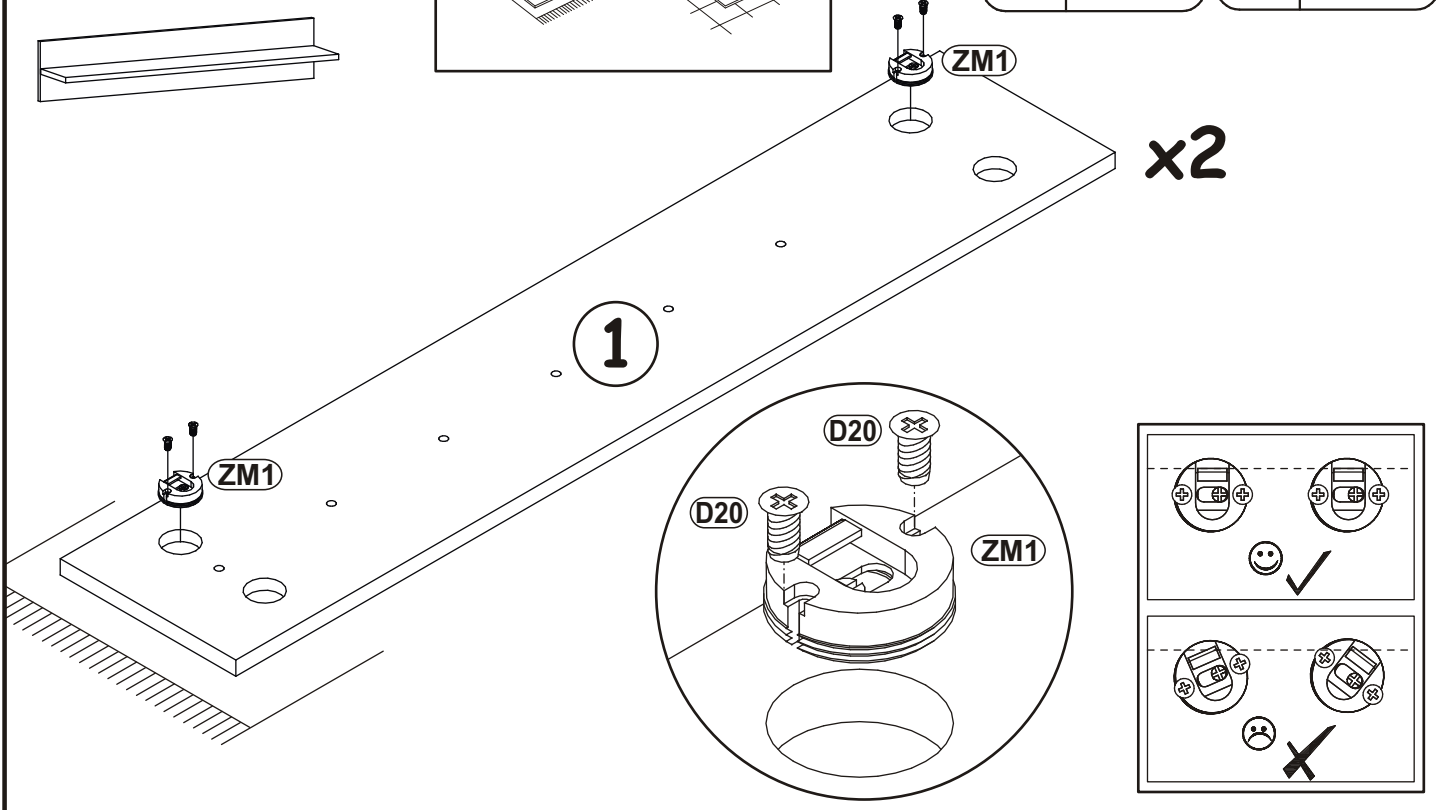
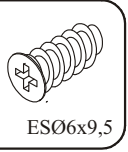

2

B11
x12

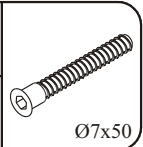

G4
x12

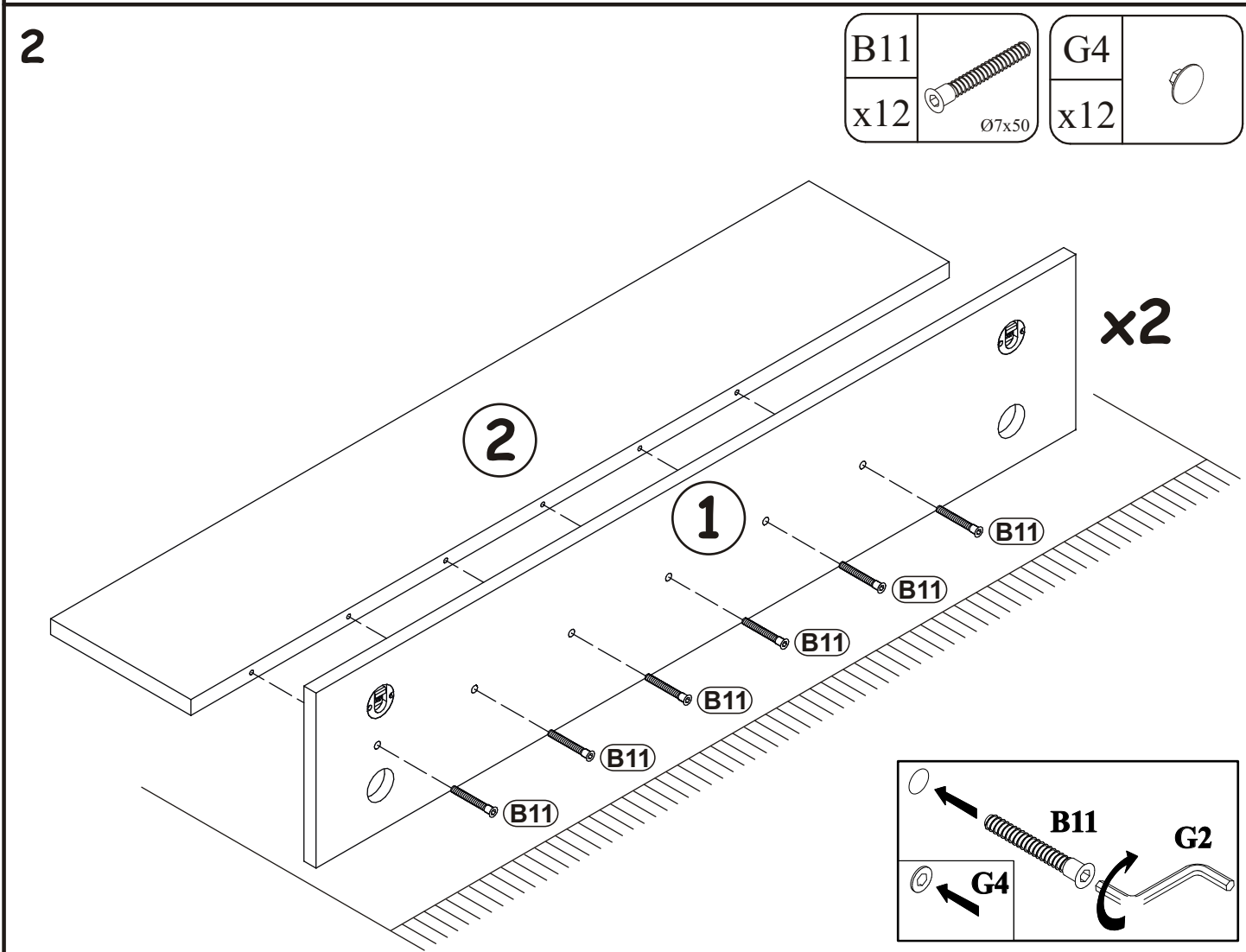
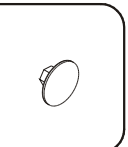

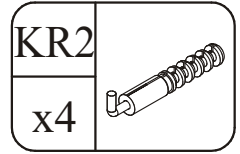

3

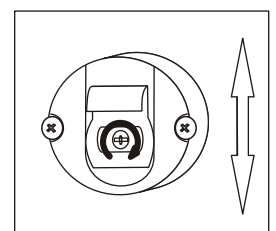
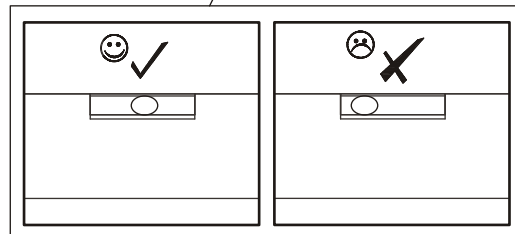
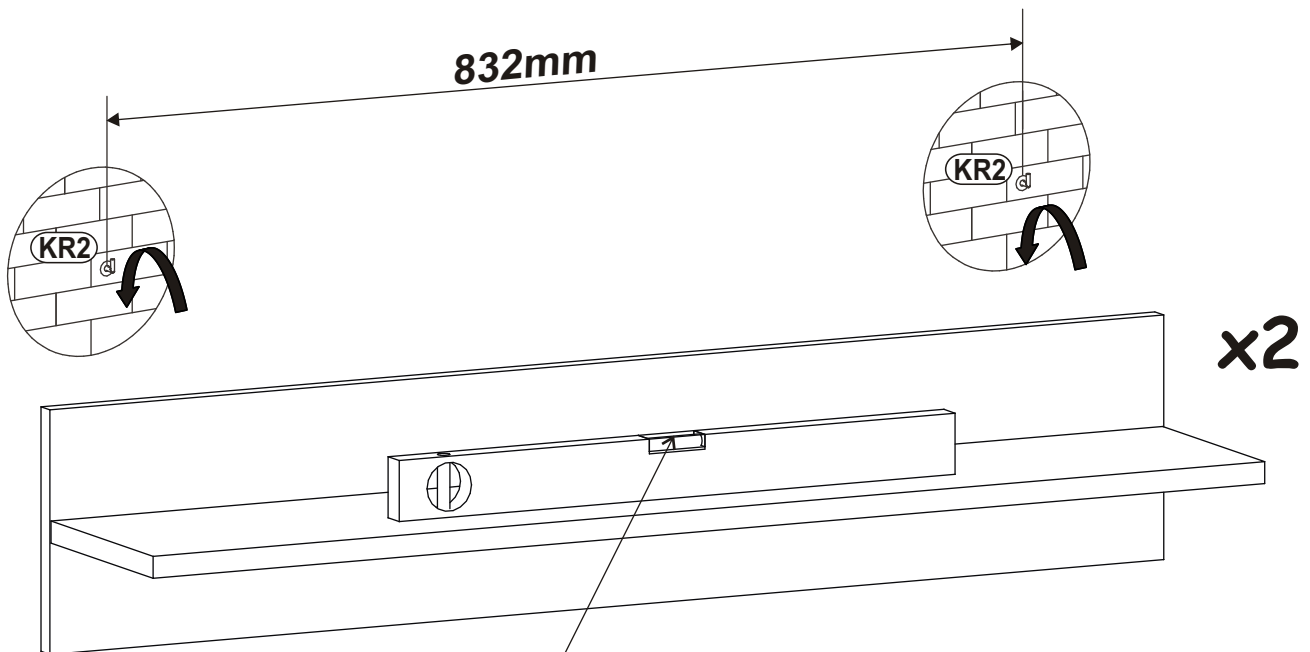
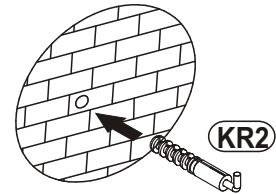
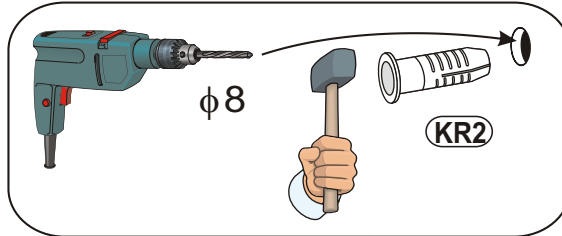
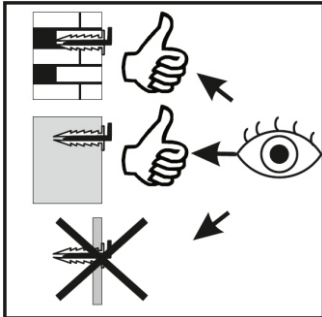

4

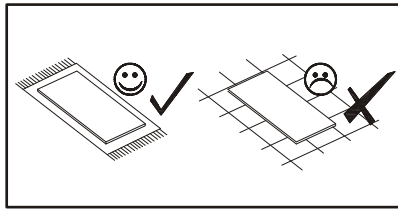

ZM1		D20	
x4		x8	ESØ6x9,5

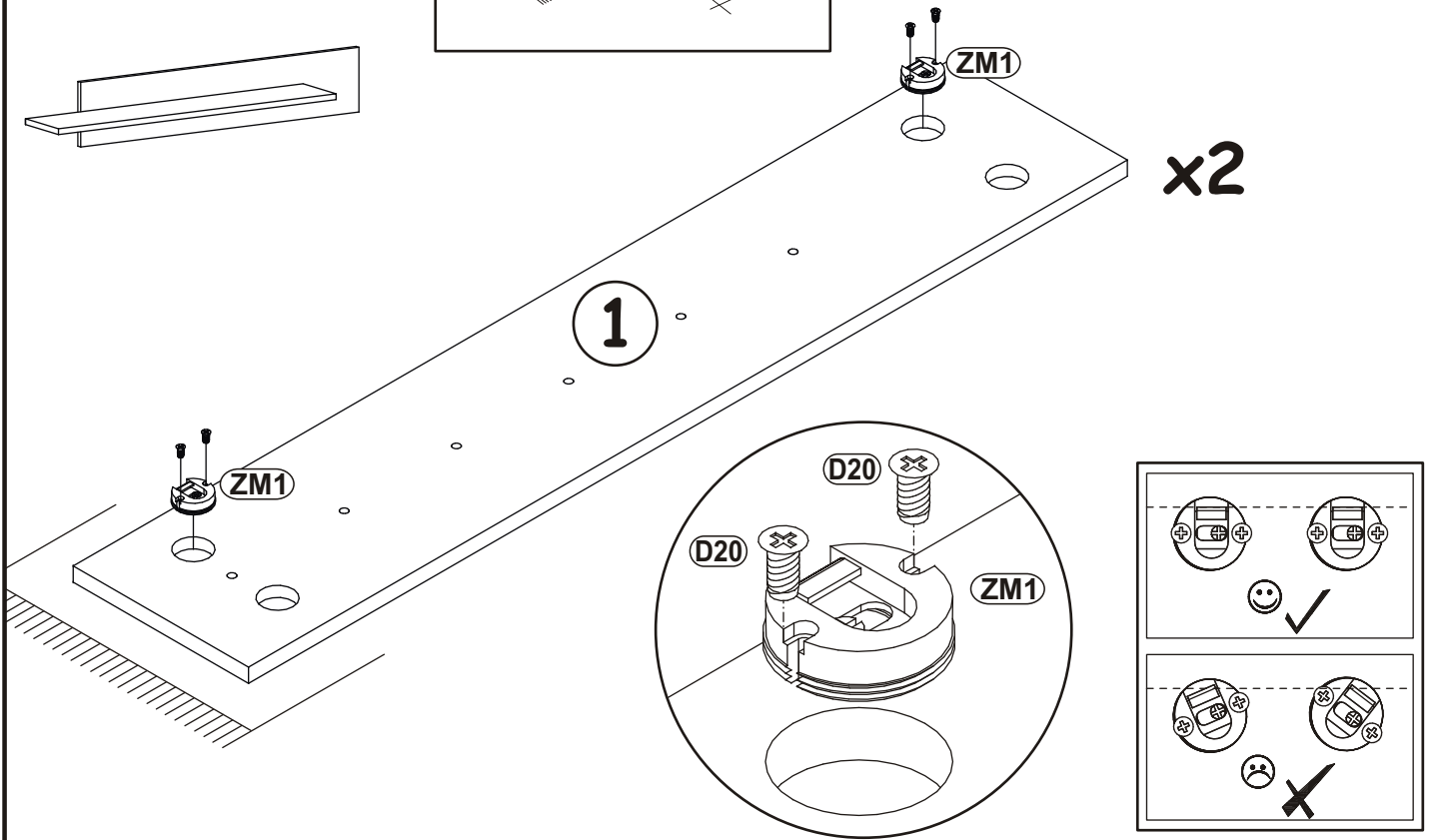

5

B11		G4	
x12	Ø7x50	x12	

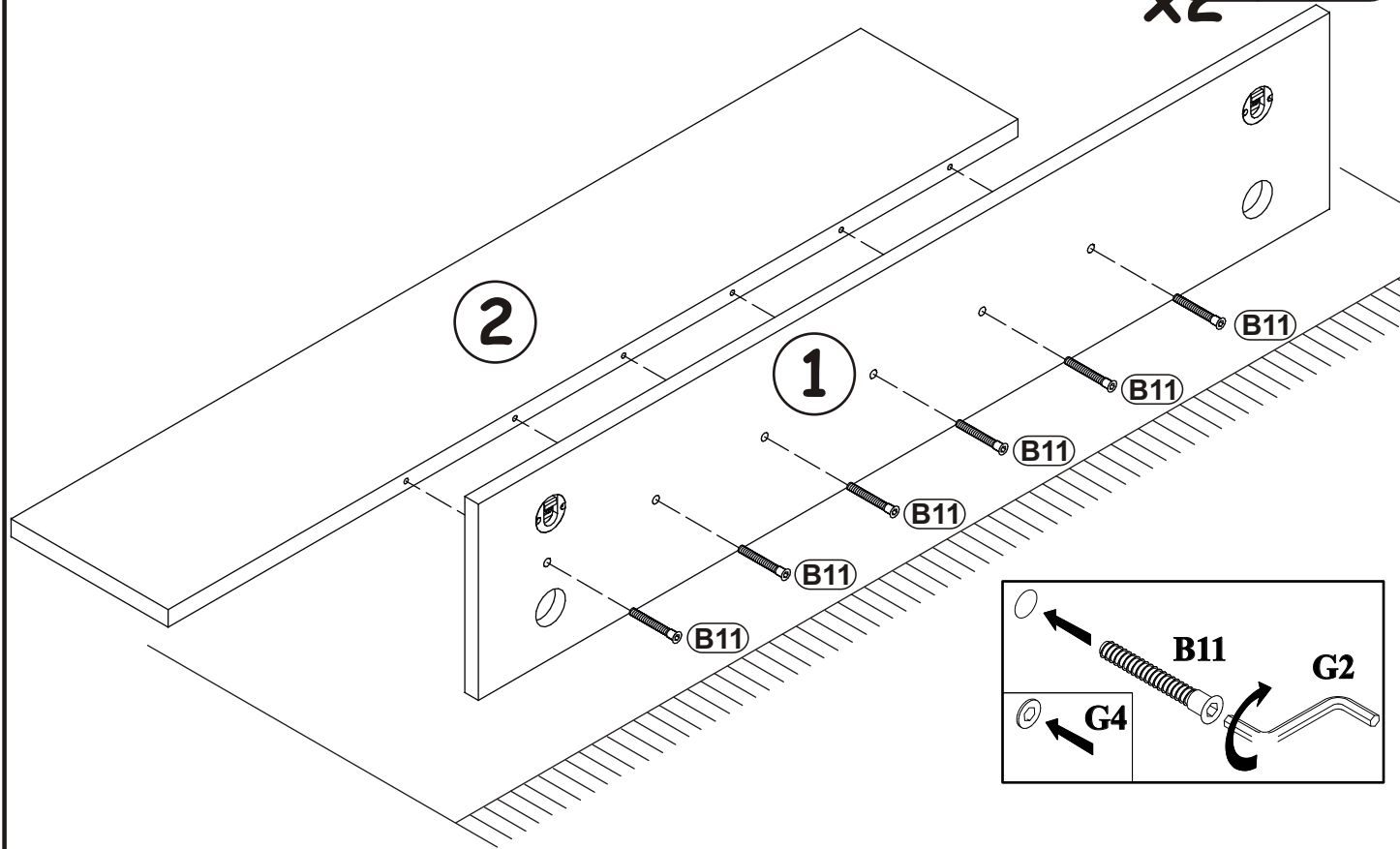

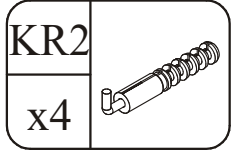

6

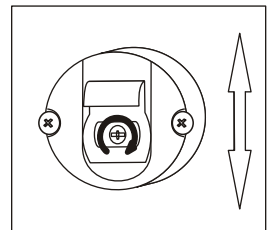
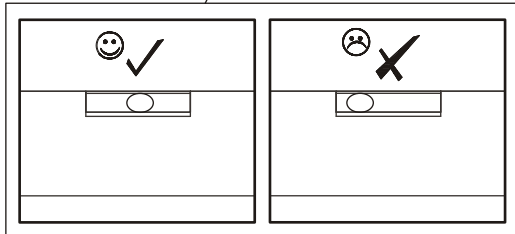
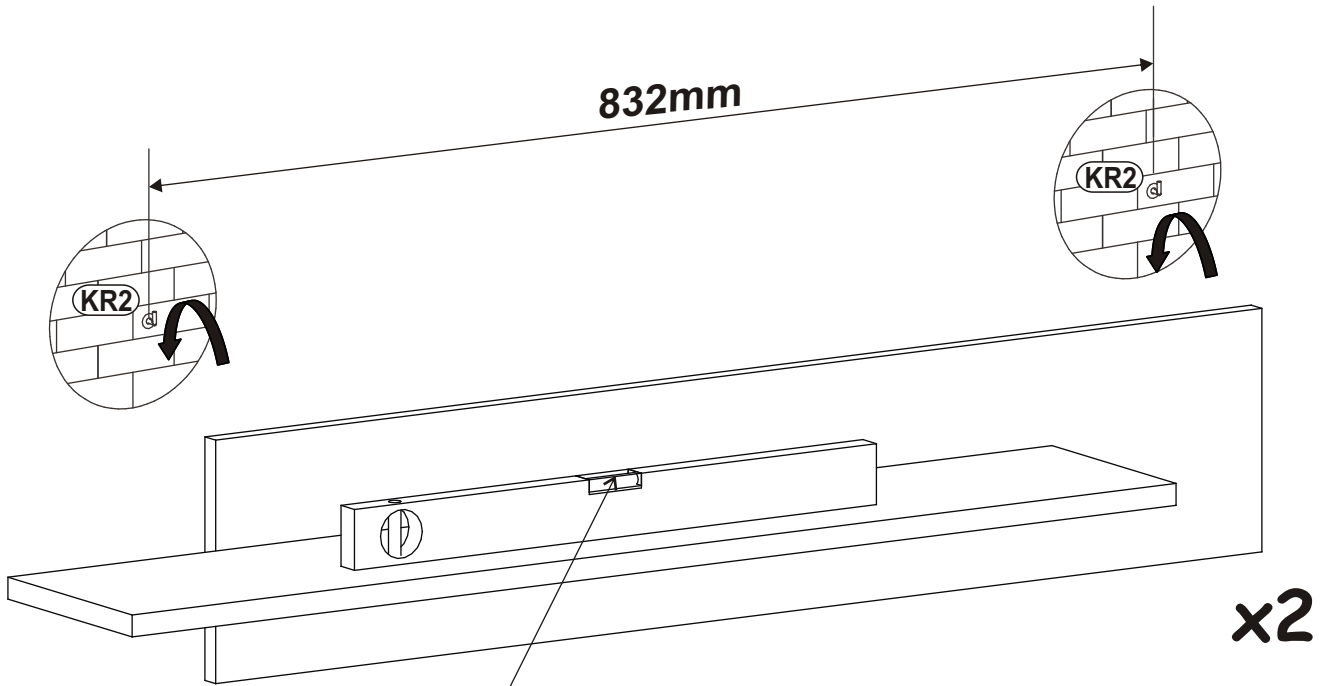
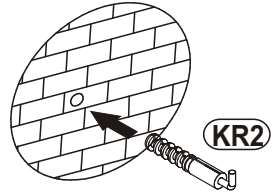
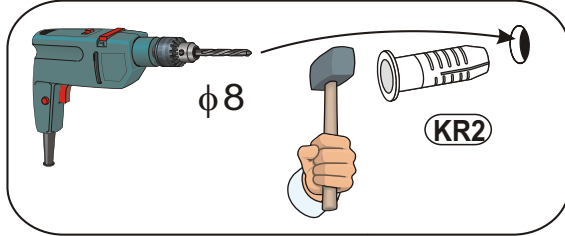
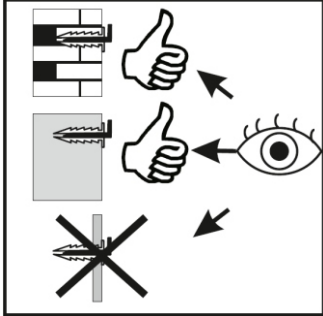
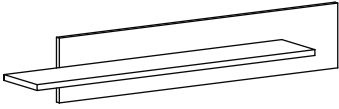

7

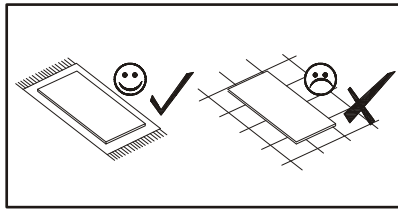

ZM1		D20	
x4		x8	ESØ6x9,5

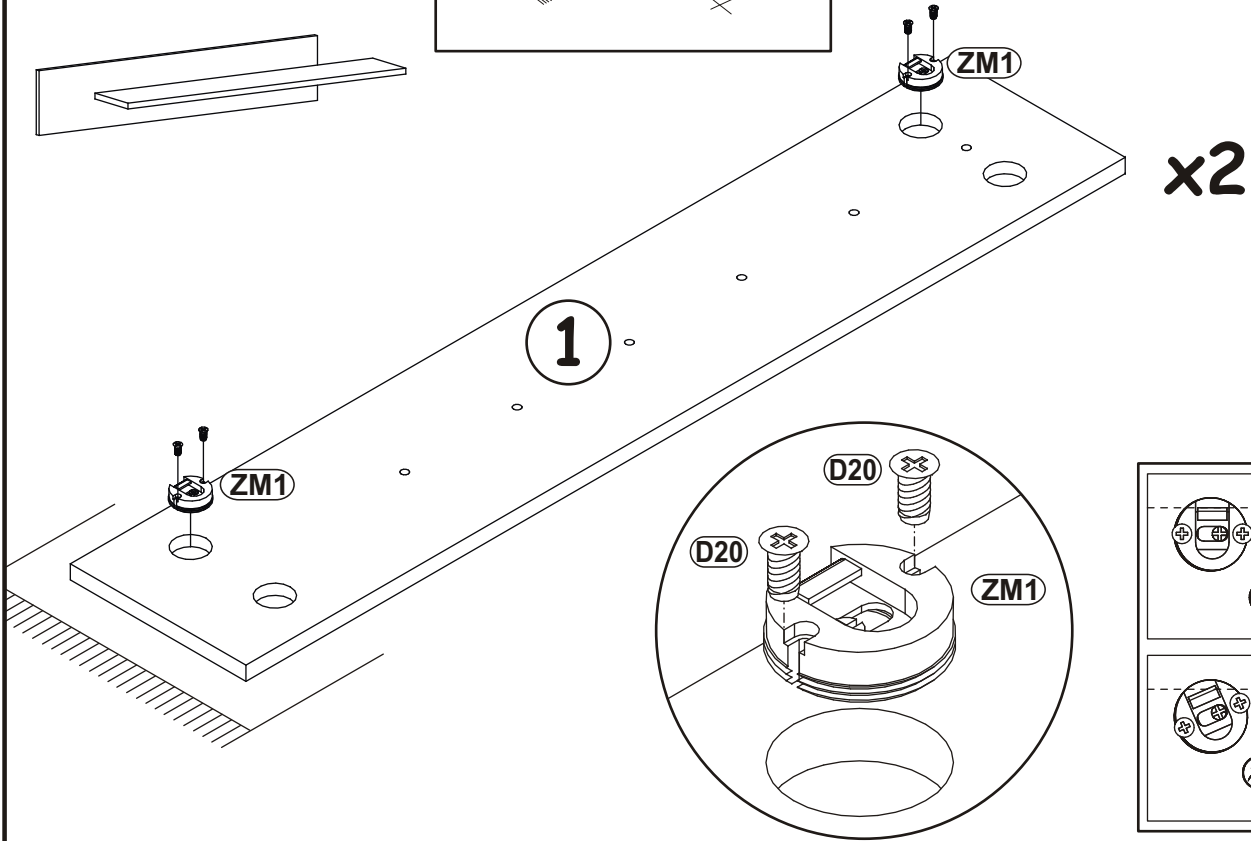

8

B11		G4	
x12	Ø7x50	x12	

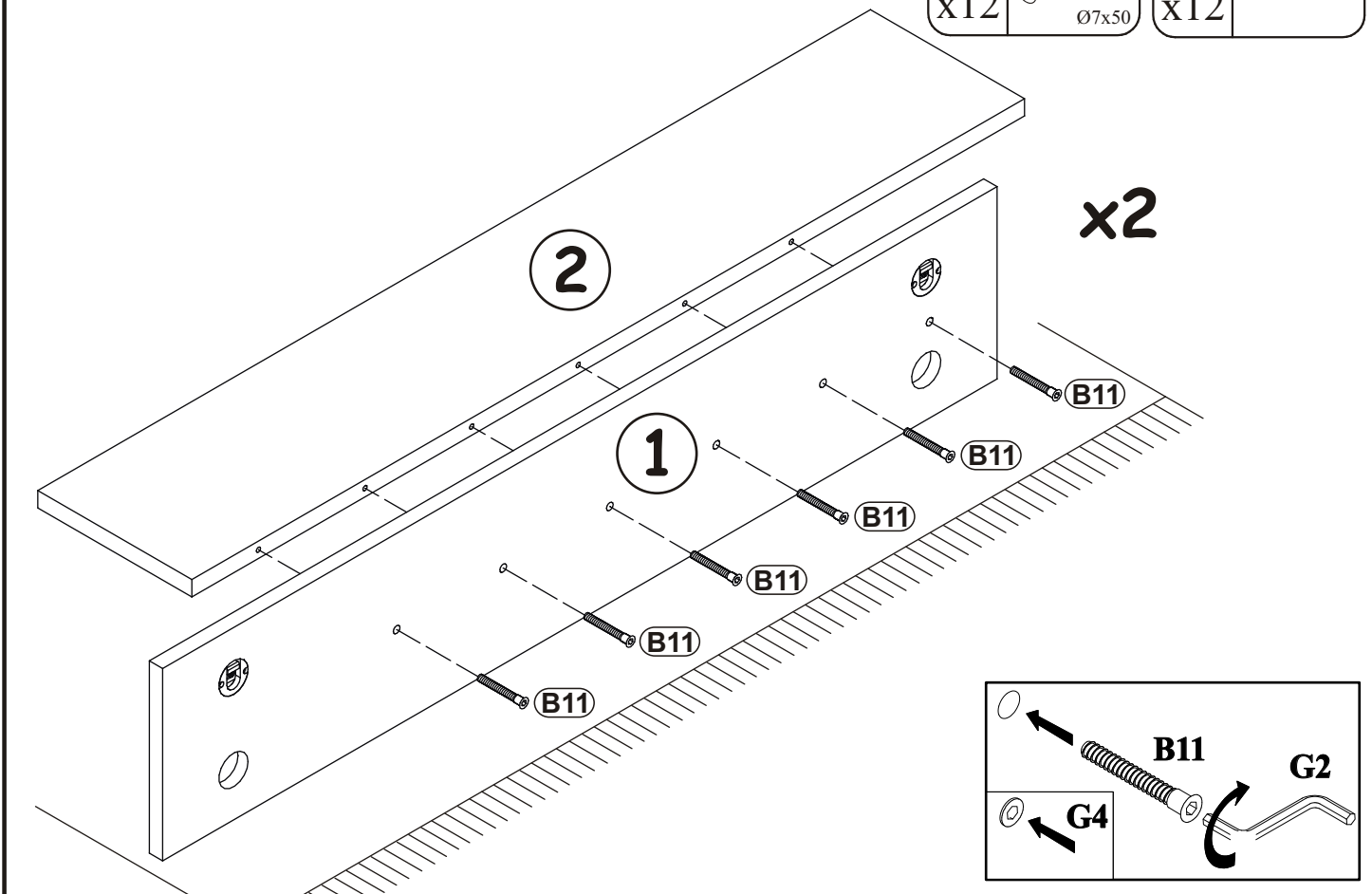

9

