

THIN 27_THWSW

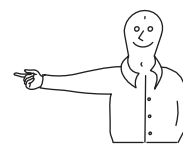

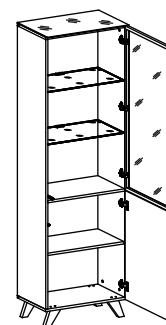

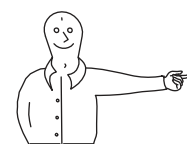

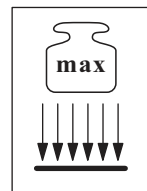
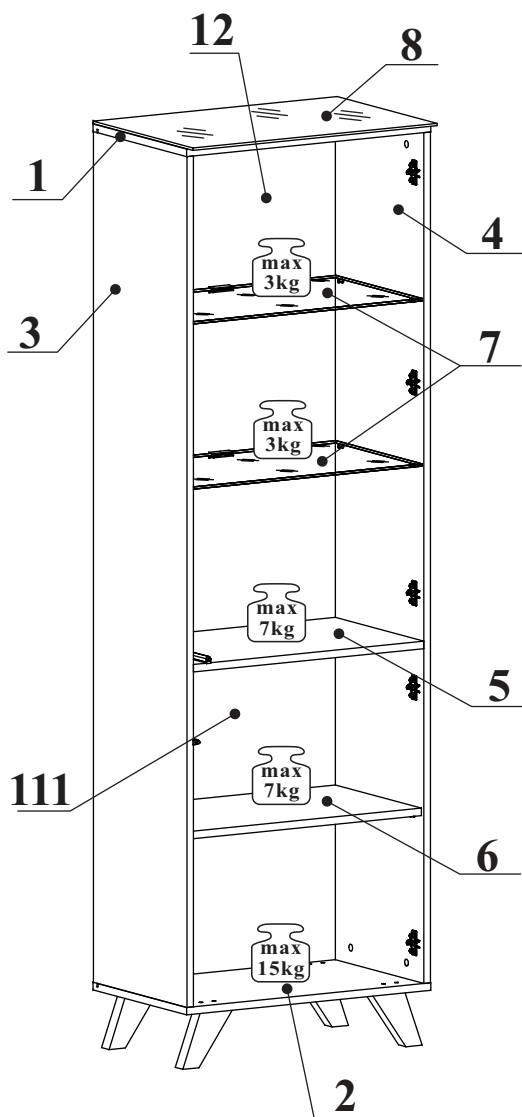
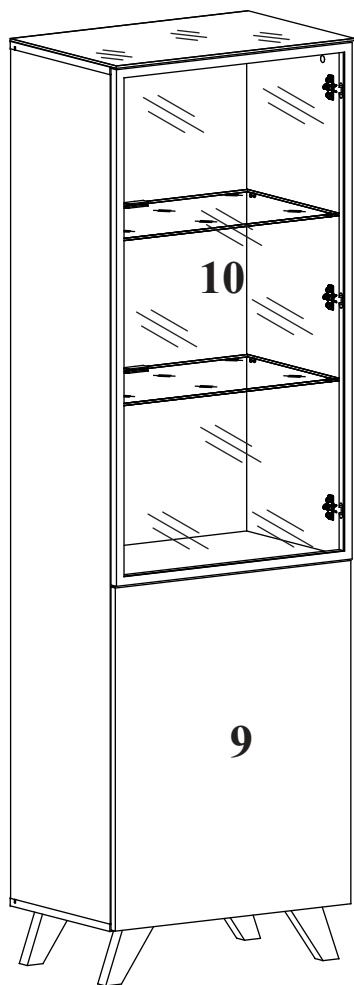



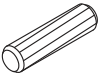
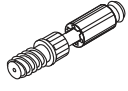



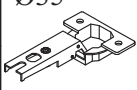
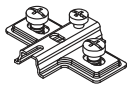
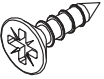
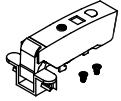
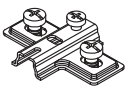

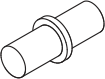
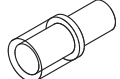
NO	Dim.[mm]			Col.-No	Qty
1	602	376	16	2	1
2	602	376	16	2	1
3	1812	376	16	2	1
4	1812	376	16	2	1
5	568	356	16	1	1
6	568	346	16	1	1
7	567	346	5	1	2
8	602	401	5	1	1
9	596	732	16	1	1
10	596	1102	21	1	1
111	580	727	3	1	1
12	1097	580	3	1	1

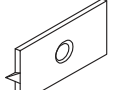

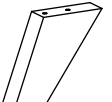
90 min

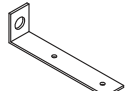
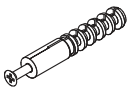
THIN 27_THWSW

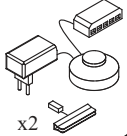
A1 x12  ø8x36	B4 x12 	B5 x12  Ø15x12	G5 x12 	B11 x8  Ø7x50	G4 x8 
E21 x2 Ø35  H=0	E2 x2  H=0	D10 x10  USØ3,5x13	E30 x3  H=0	E4 x3  H=2	Z2 x10  Ø5
G7 x4 	G20 x8 	S1 x16 	G16 x4 	UP13 x4  UPØ3x16	SK x4  H=120
OD1 x2 	L1 x1 	KR1 x1 	G2 x1 	LED x1  x2	

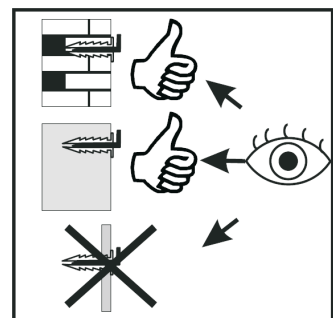
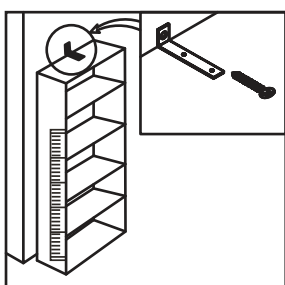
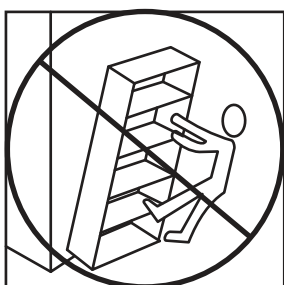
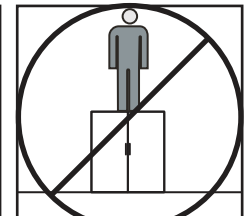
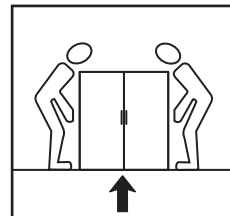
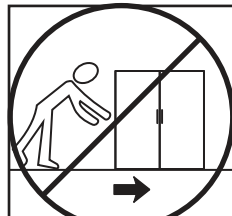
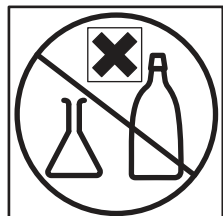
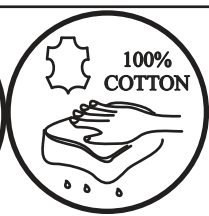
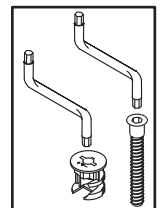
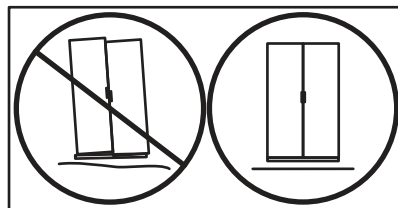
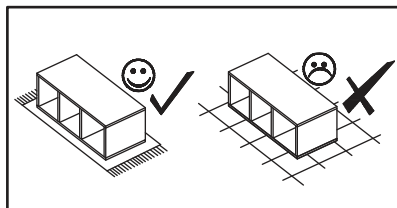
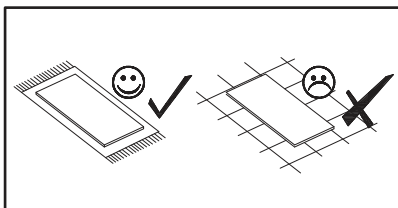
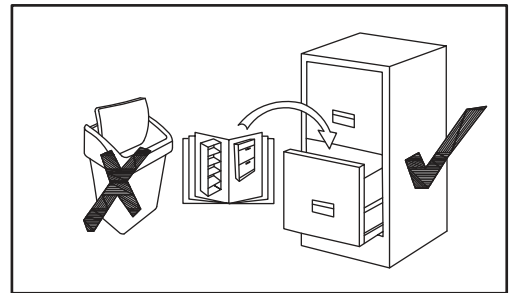
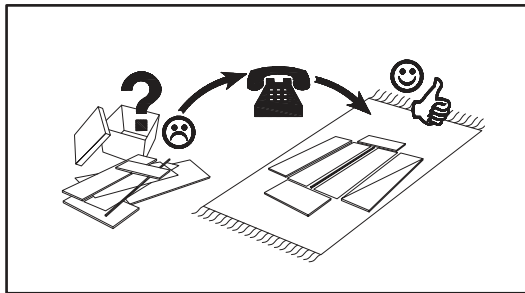
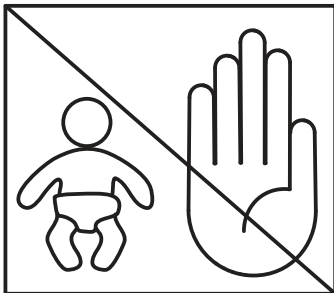
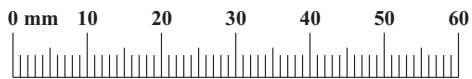

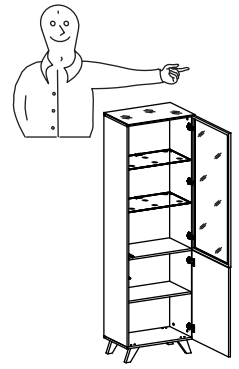

1

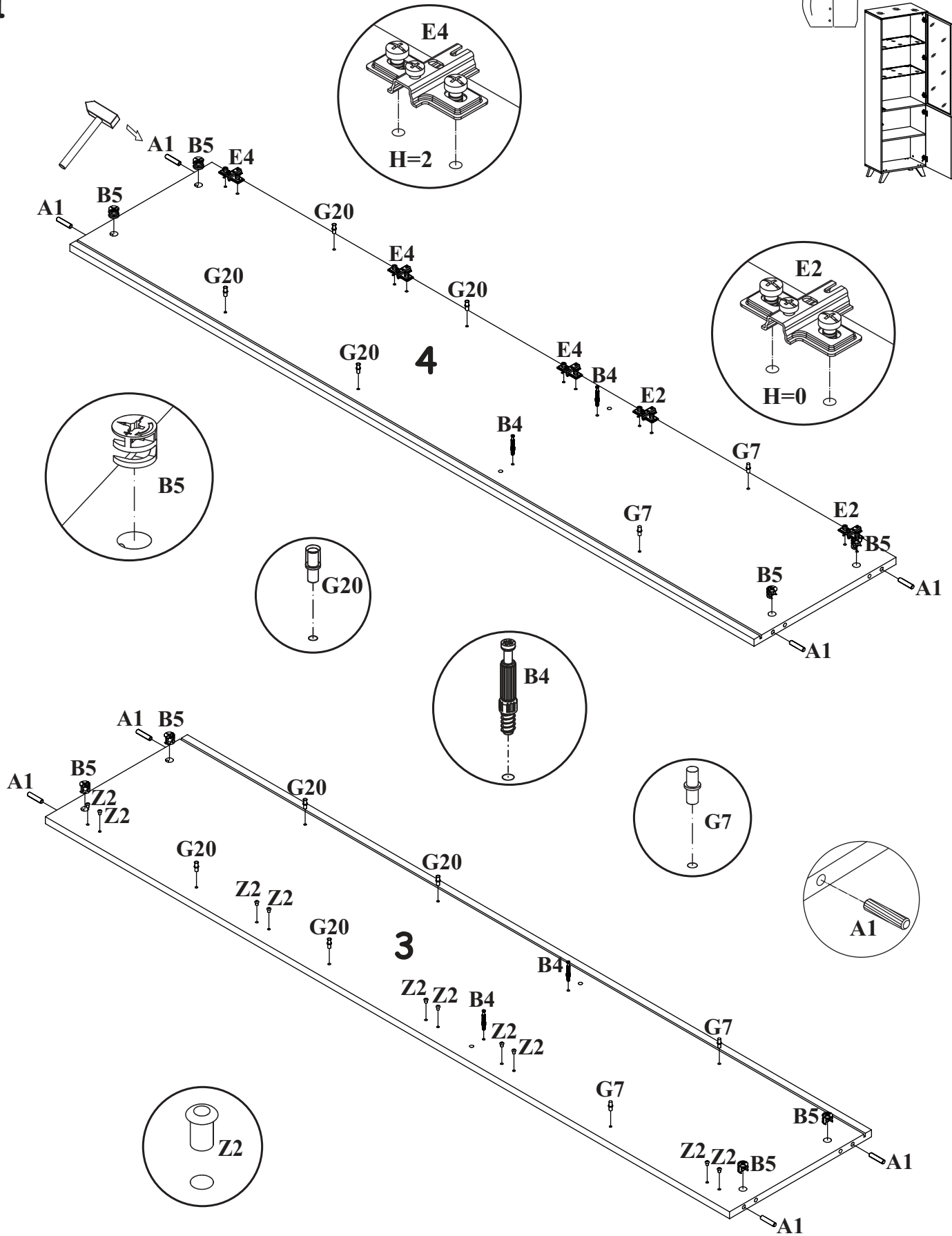

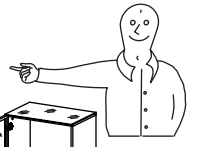

1

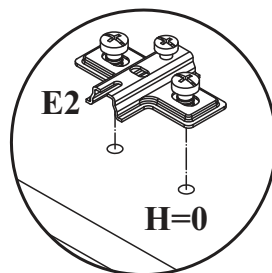
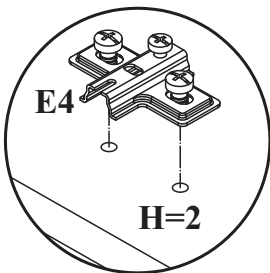
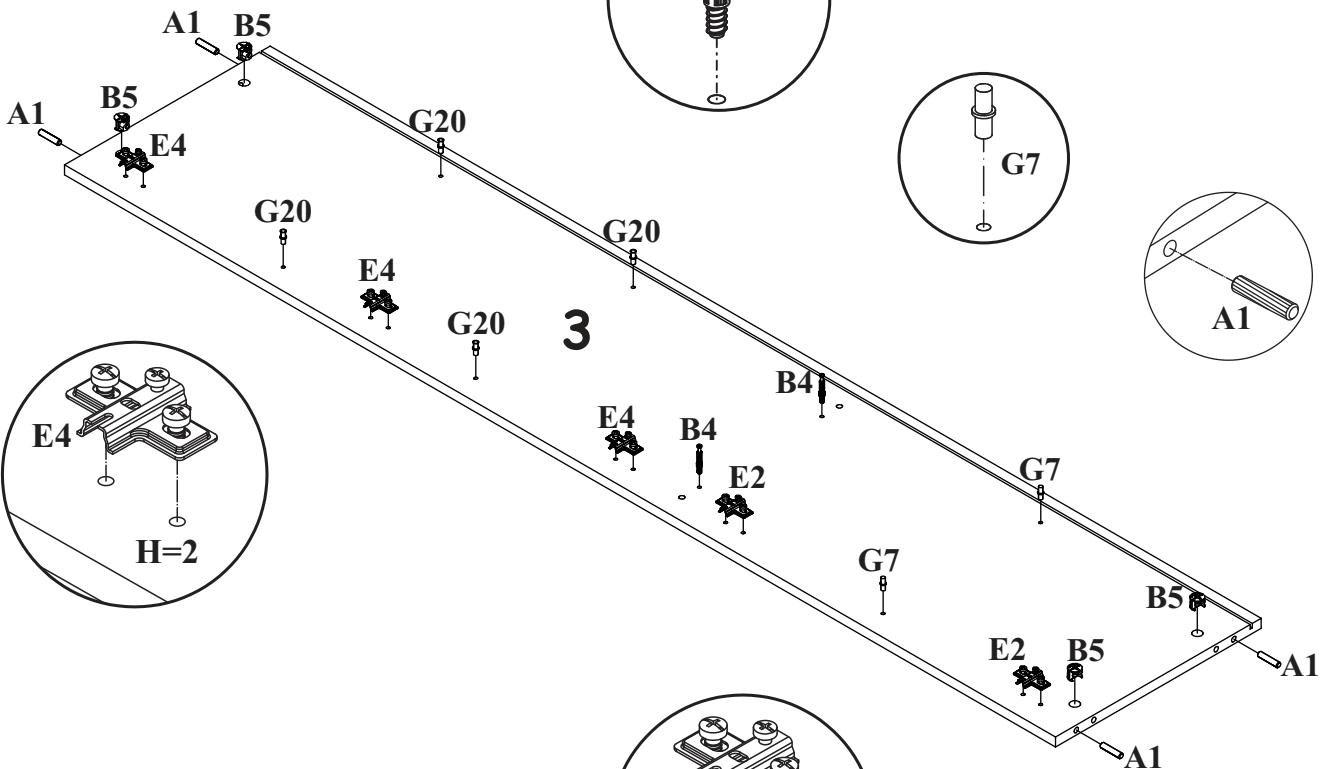
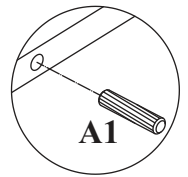
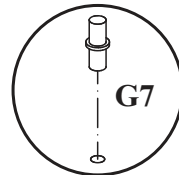
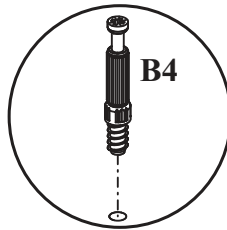
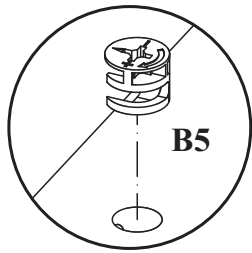
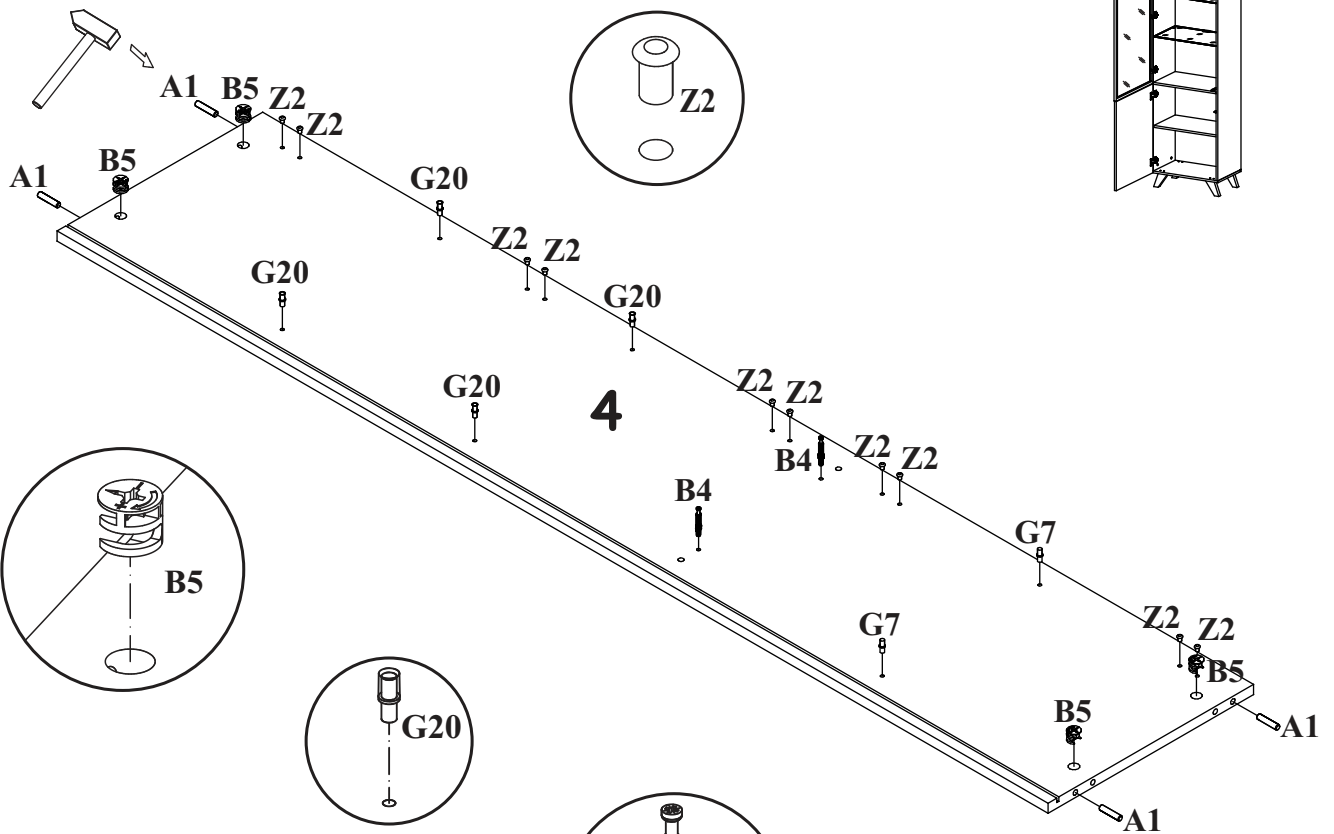

2

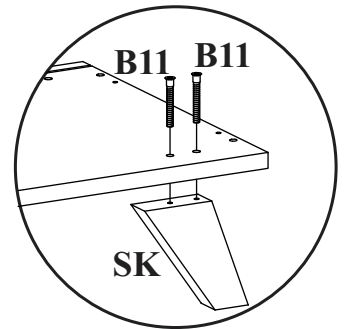
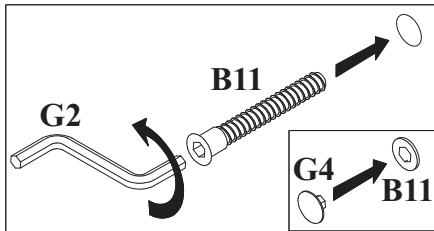
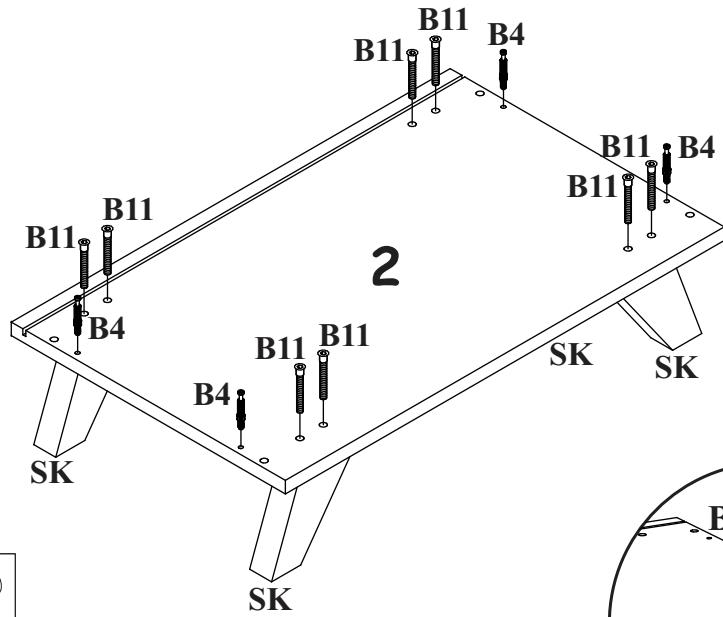
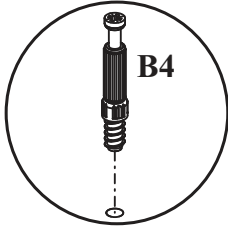
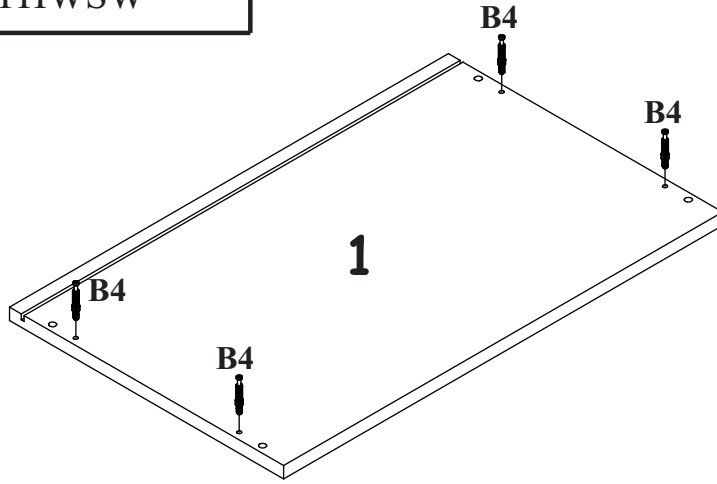

3

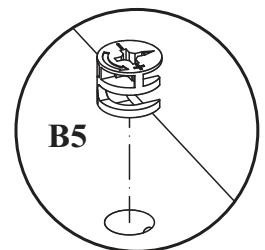
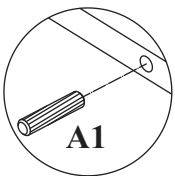
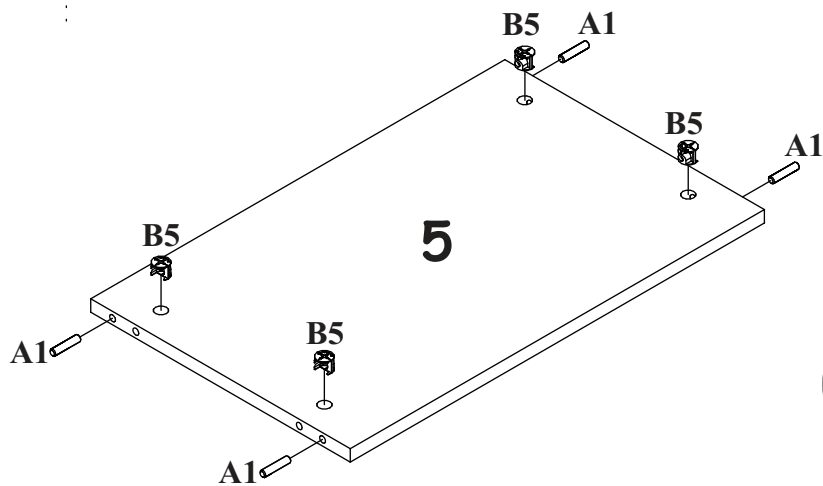

4

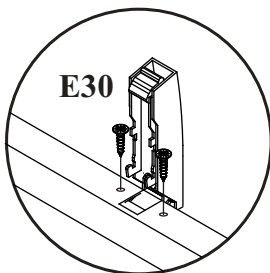
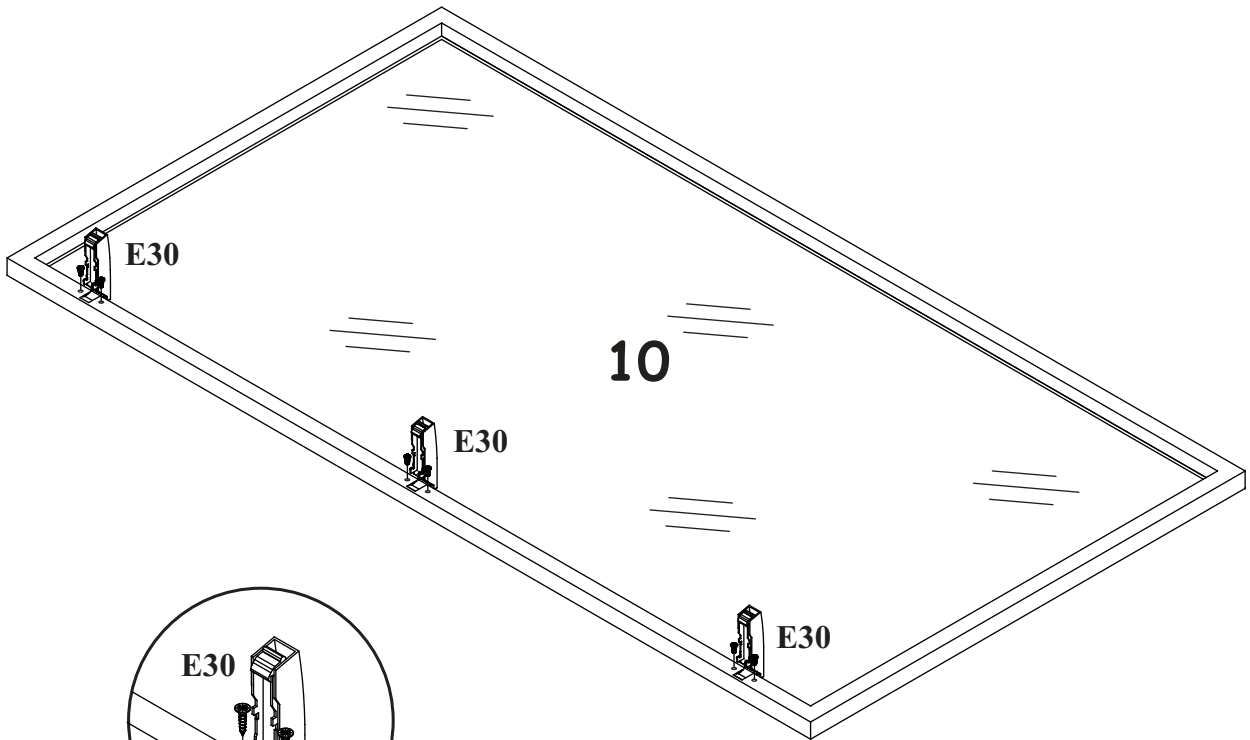
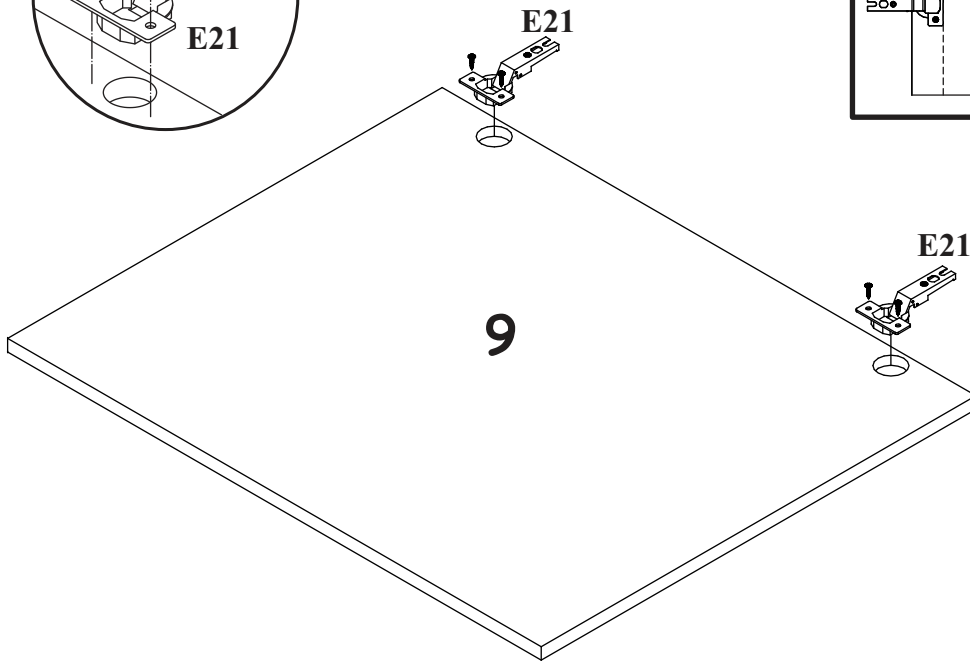
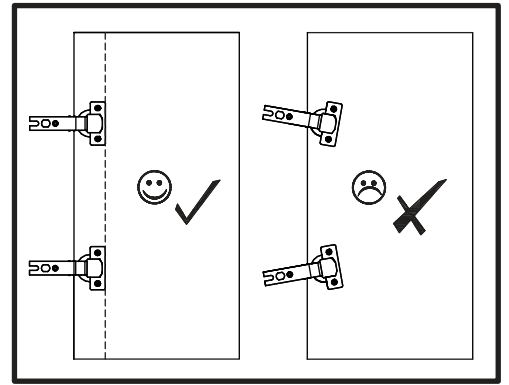
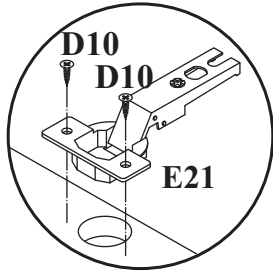

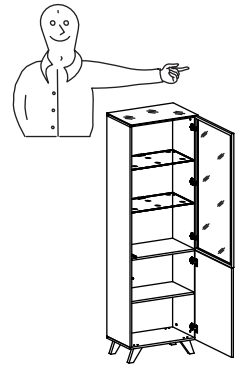

5

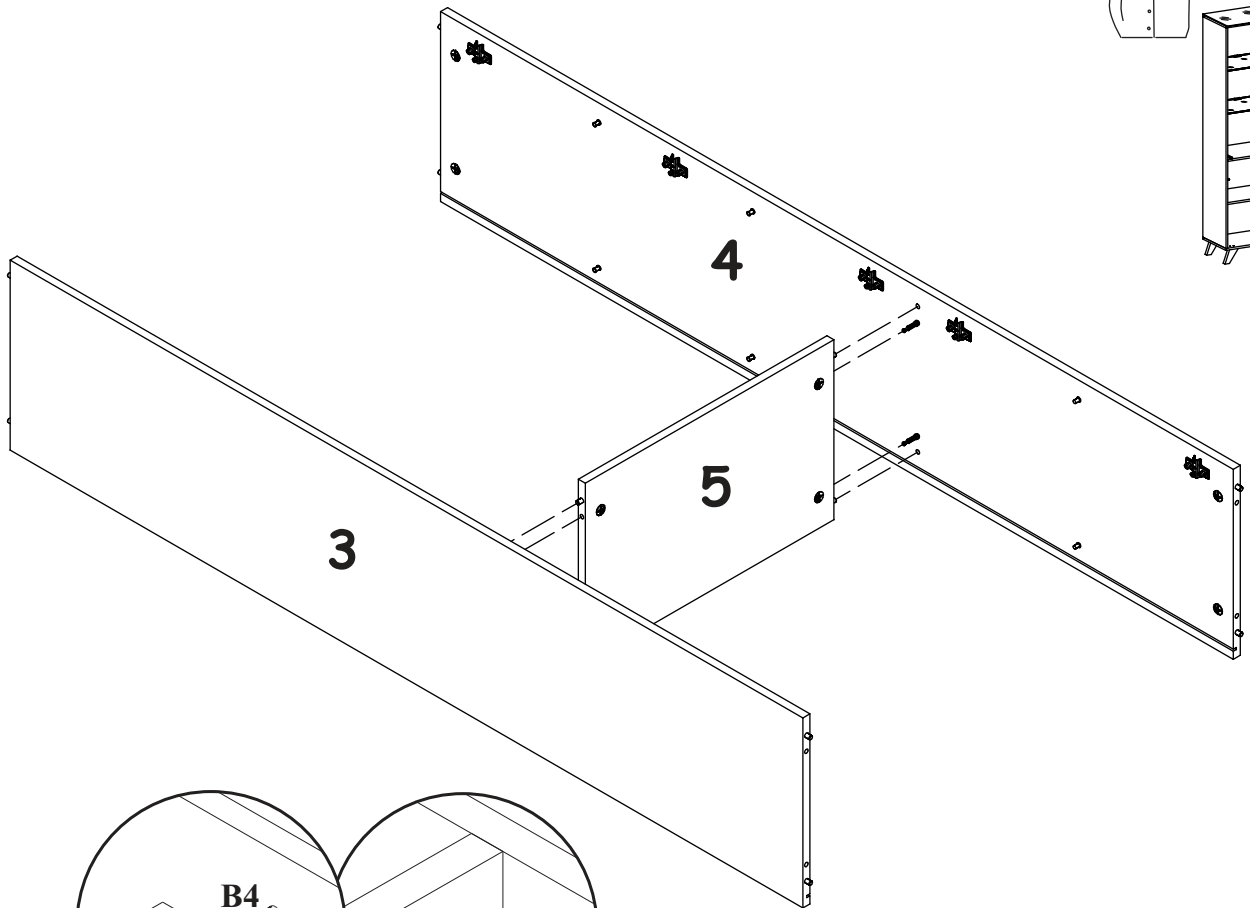

5

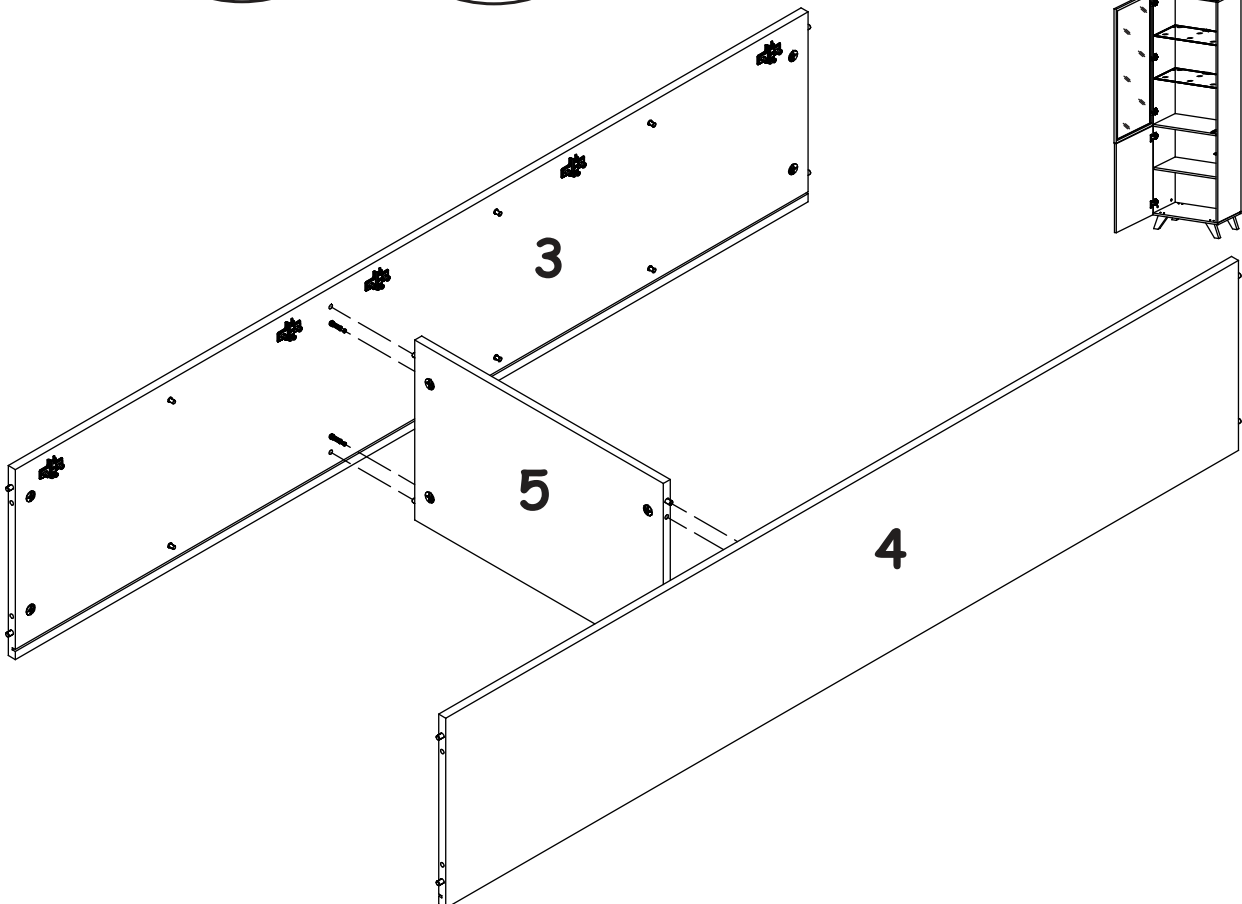
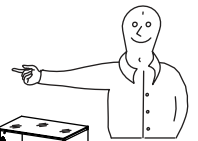
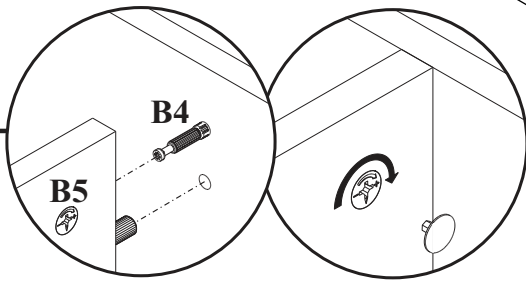

6

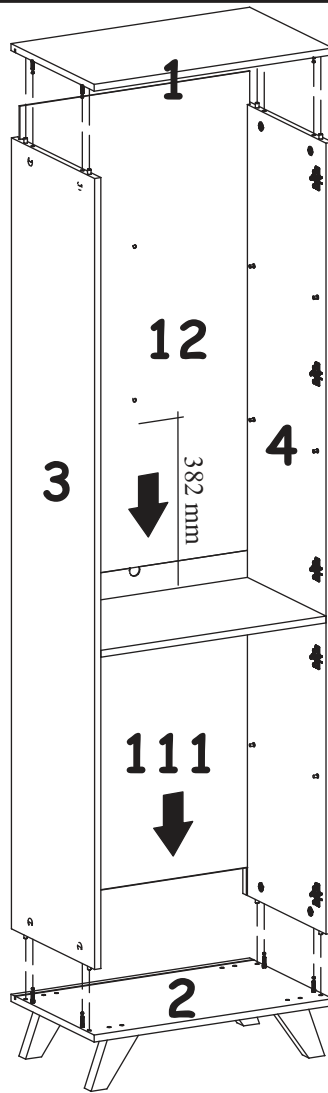
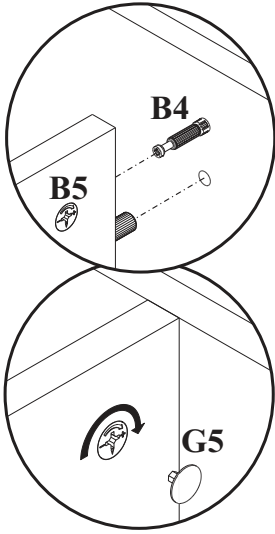

7

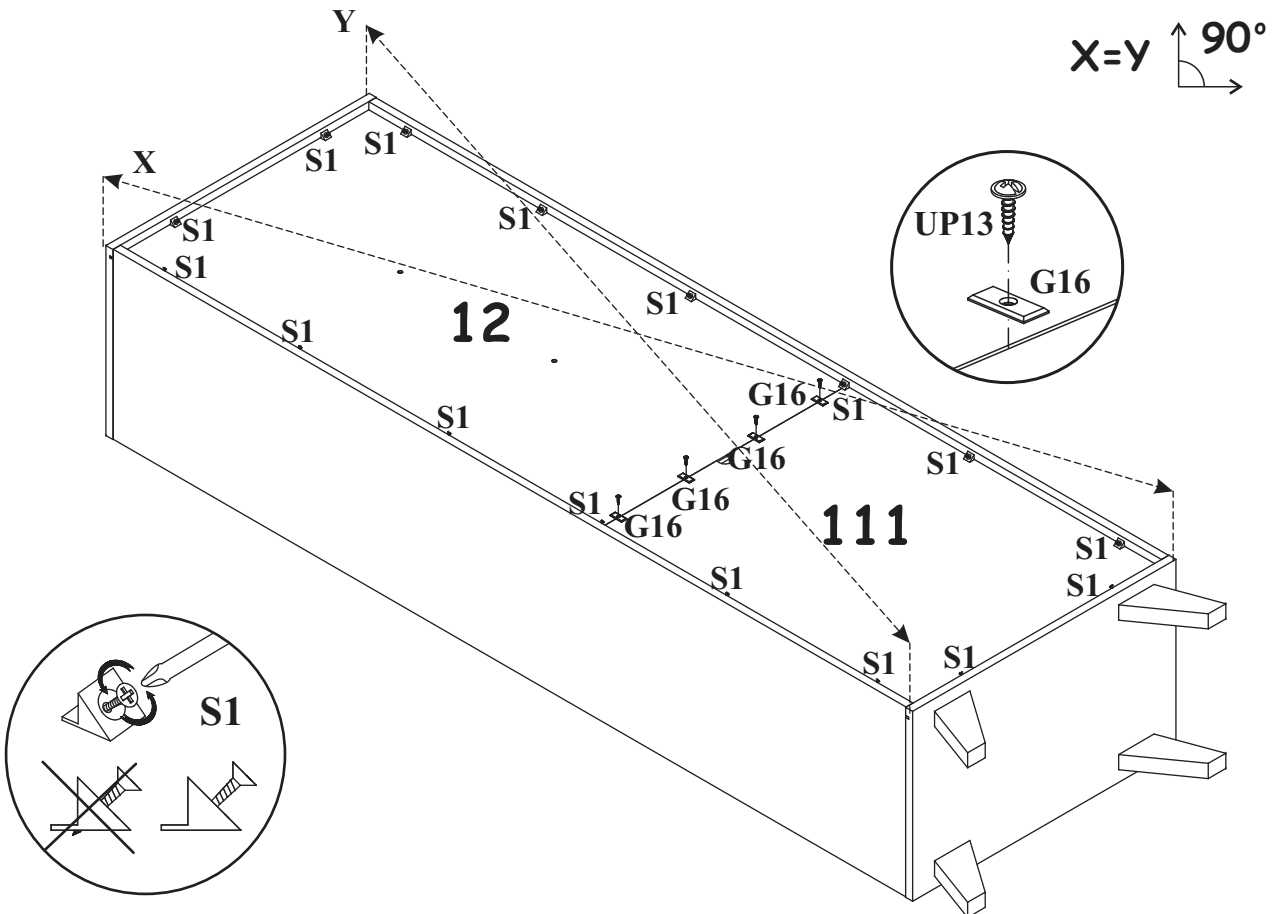

8

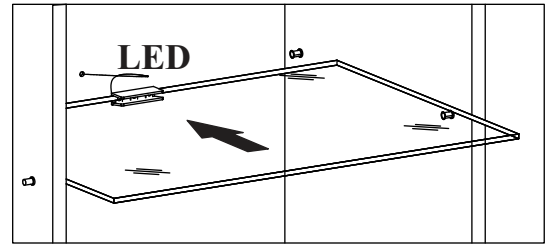
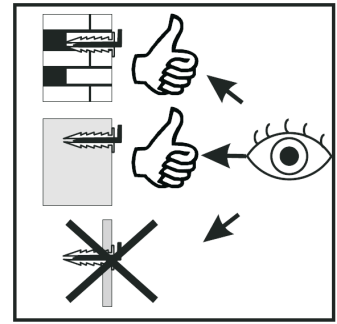
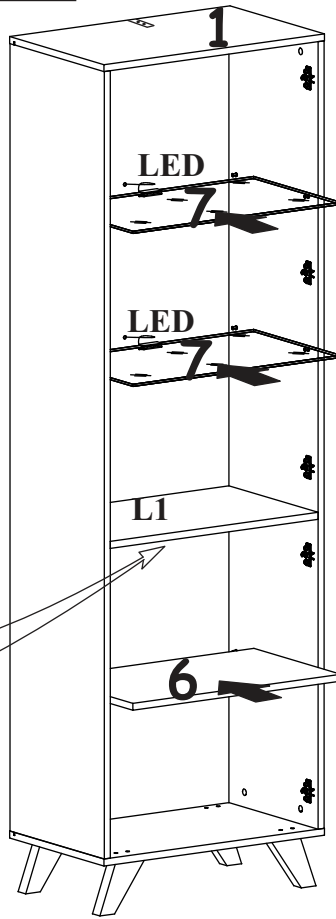
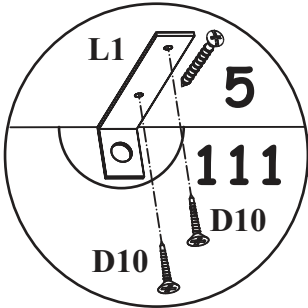
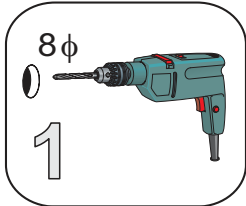

9

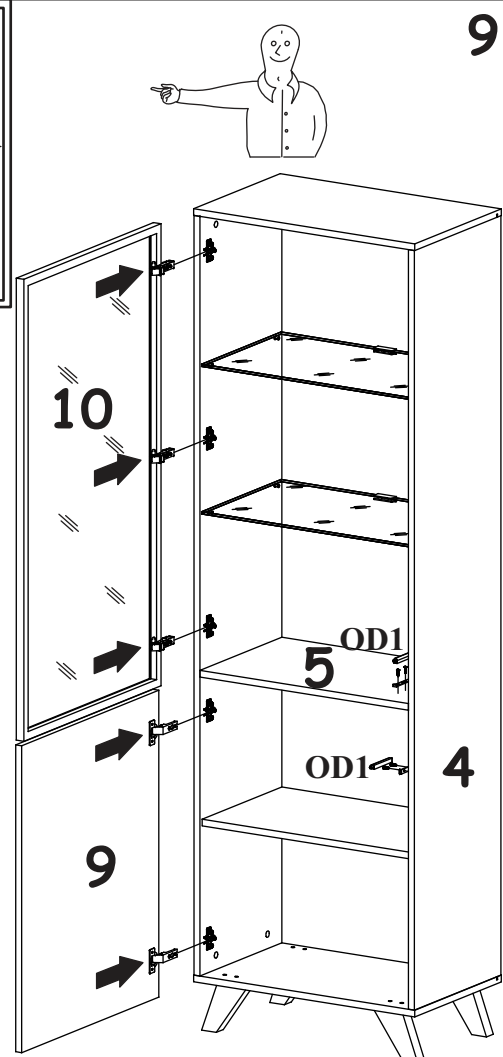
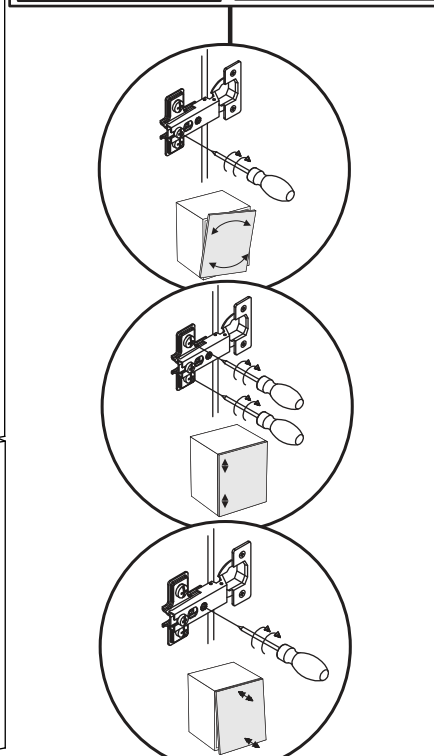
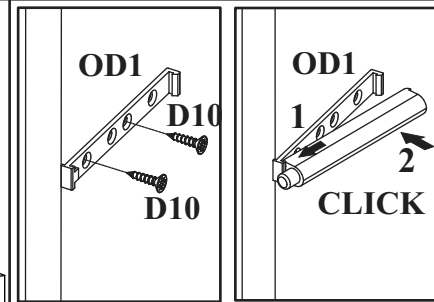
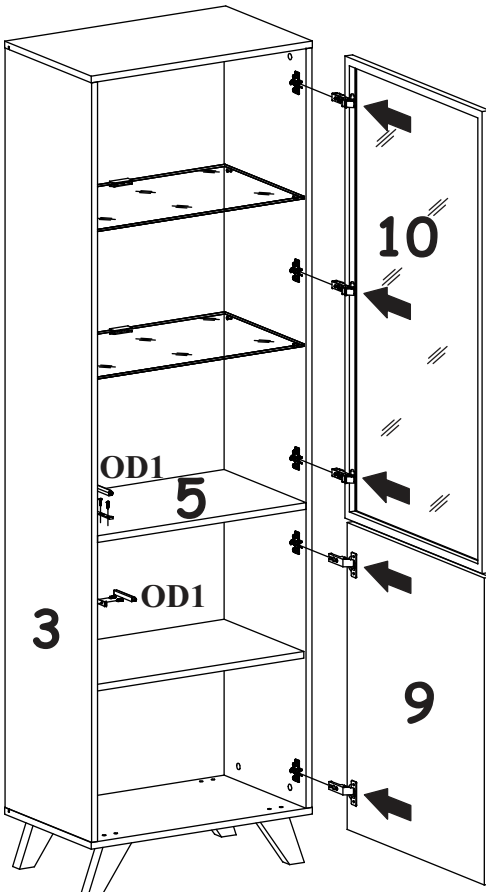
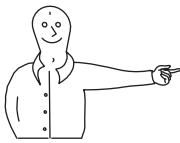

9

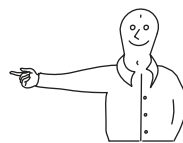

10

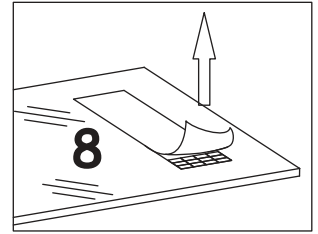
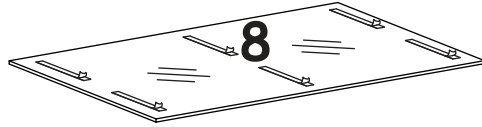

11

