

THIN 27_THWSN

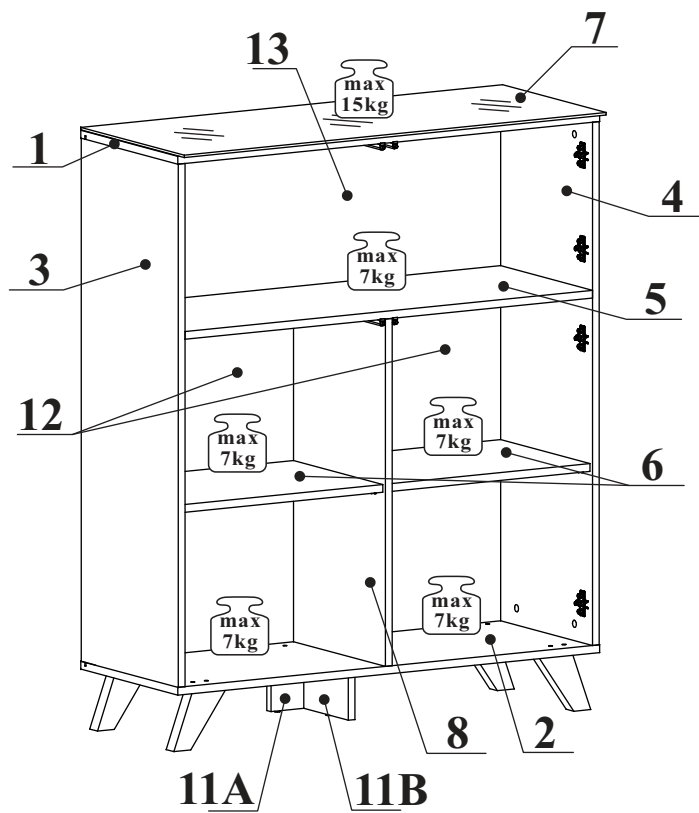

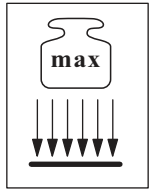

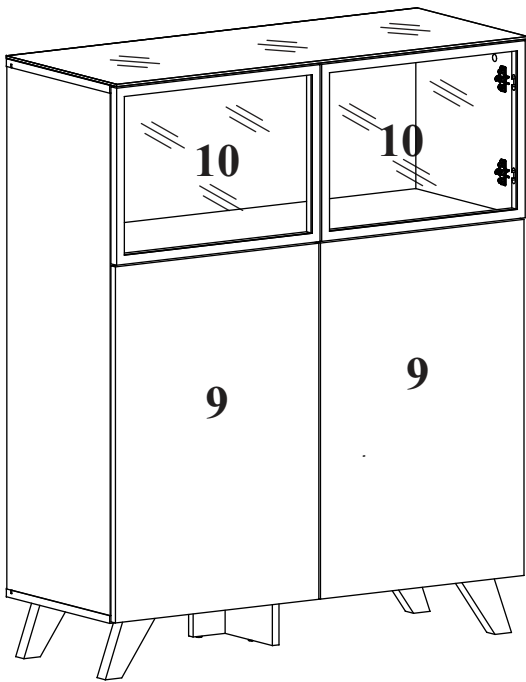

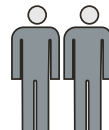
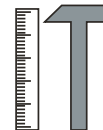
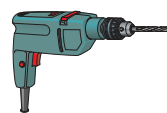



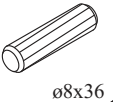
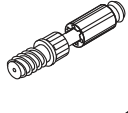

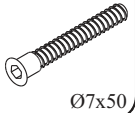

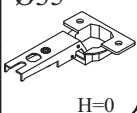
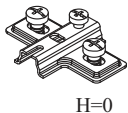
NO	Dim.[mm]			Col.-No	Qty
1	1002	376	16	1	1
2	1002	376	16	1	1
3	1074	376	16	1	1
4	1074	376	16	1	1
5	968	356	16	1	1
6	476	346	16	1	2
7	1002	401	5	1	1
8	713	356	16	1	1
9	496	732	16	2	2
10	496	364	21	2	2
11A	115	172	16	1	1
11B	115	172	16	1	1
12	490	727	3	2	2
13	980	359	3	1	1

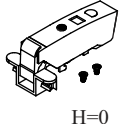
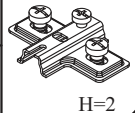
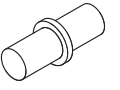
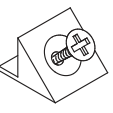
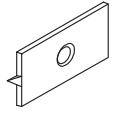

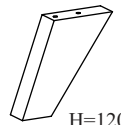
90 min

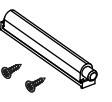
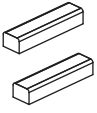
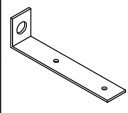
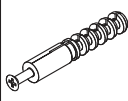
THIN 27_THWSN

A1 x16 	B4 x16 	B5 x16 	G5 x16 	B11 x14 	G4 x14 
E21 x4 Ø35 	E2 x4 	D10 x18 USØ3,5x13 	E30 x4 H=0 	E4 x4 H=2 	G7 x8 
S1 x16 	G16 x10 	UP13 x10 UPØ3x16 	SK x4 H=120 	I2 x3 	OD1 x4 
LED X2 	L1 x1 	KR1 x1 	G2 x1 		

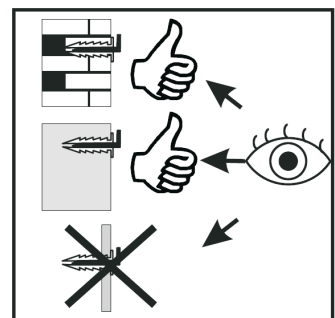
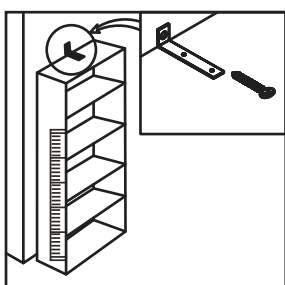
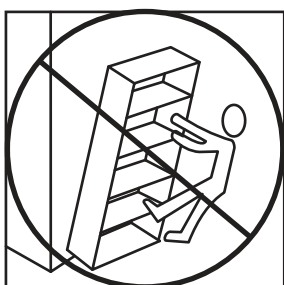
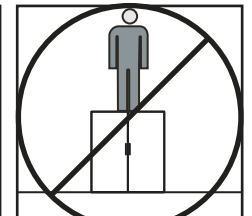
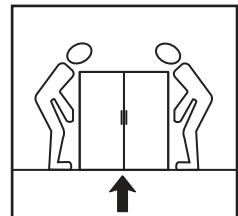
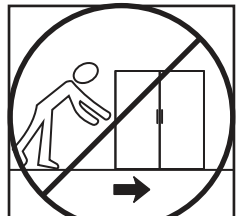
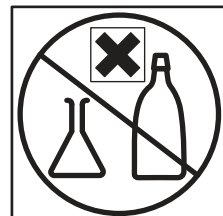
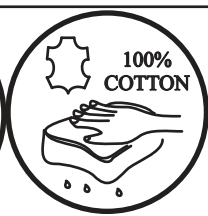
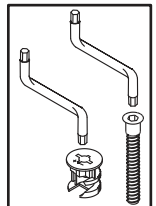
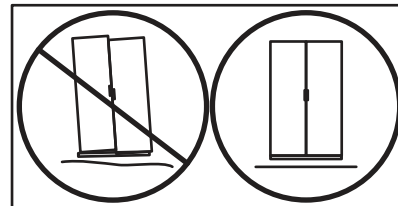
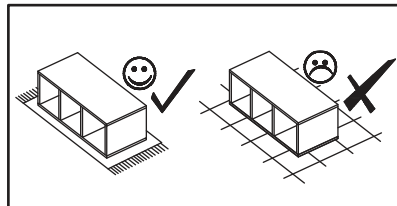
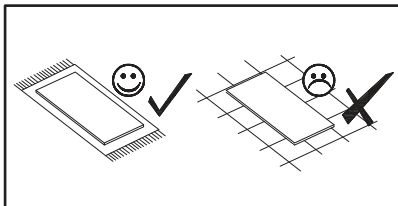
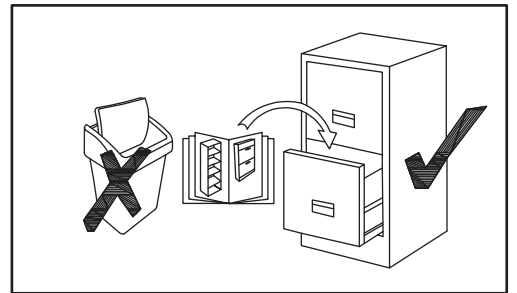
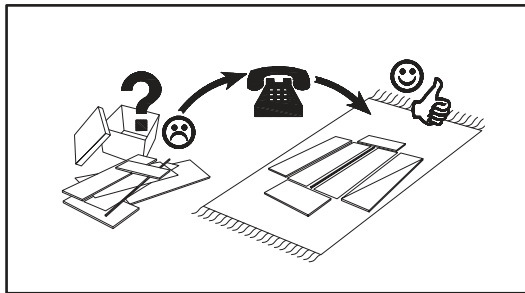
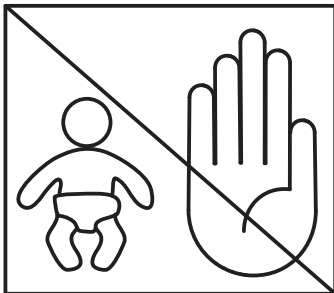
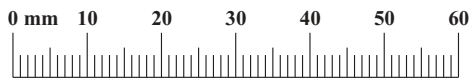

1

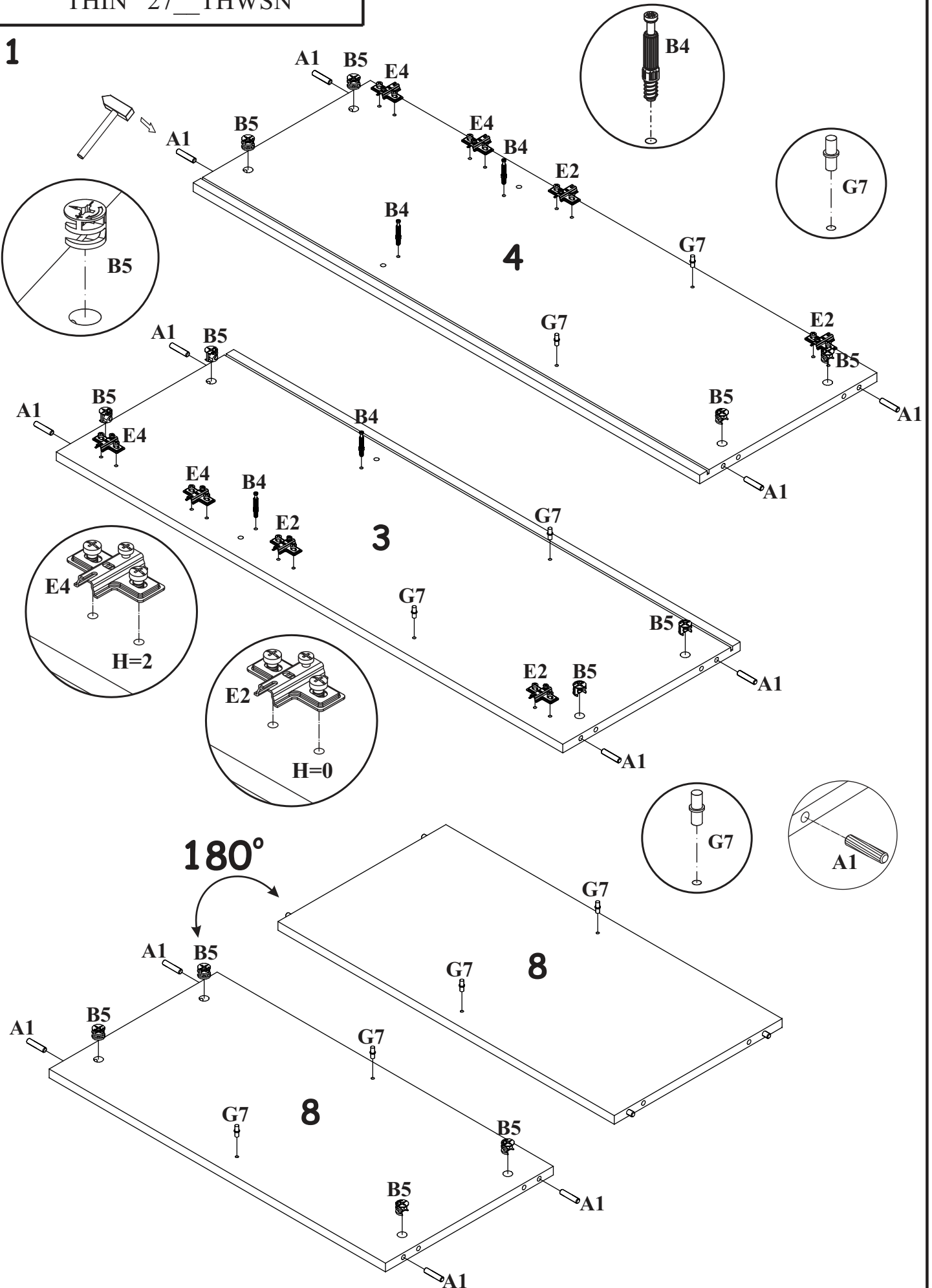

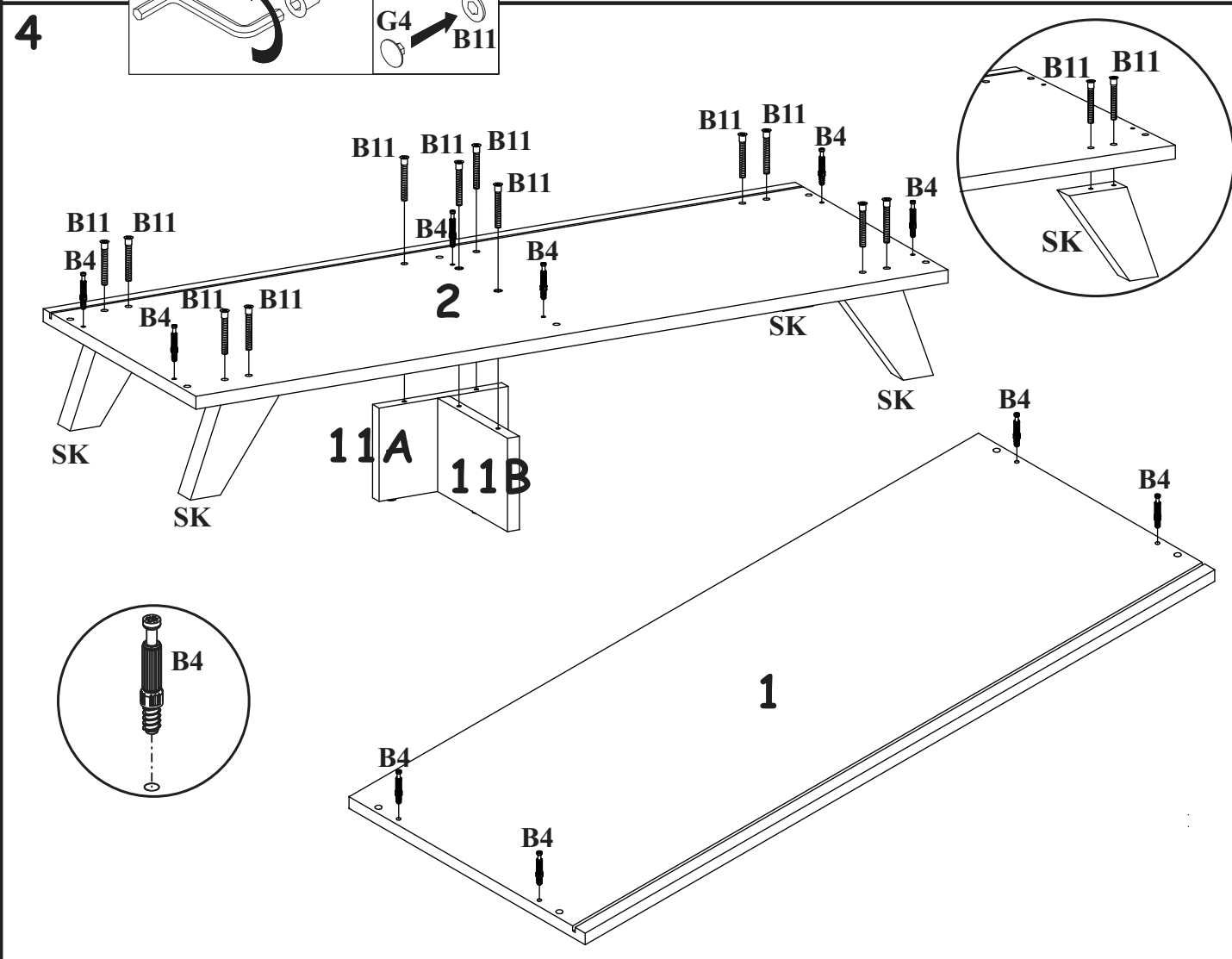
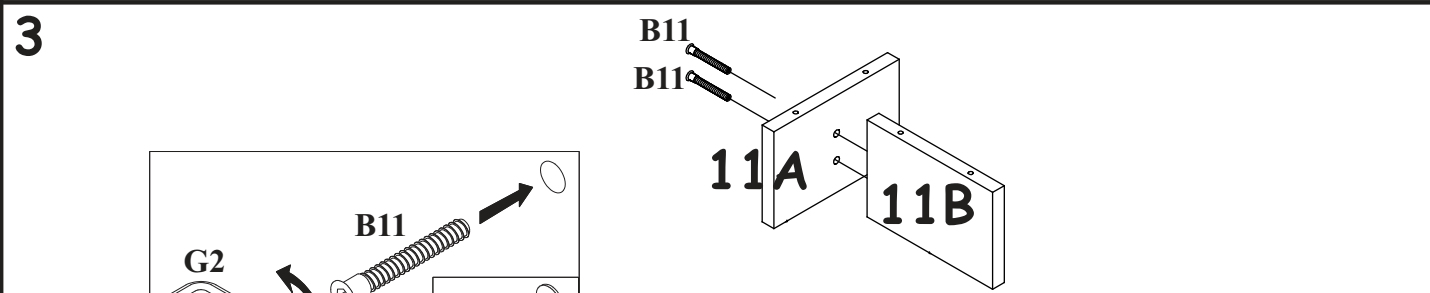
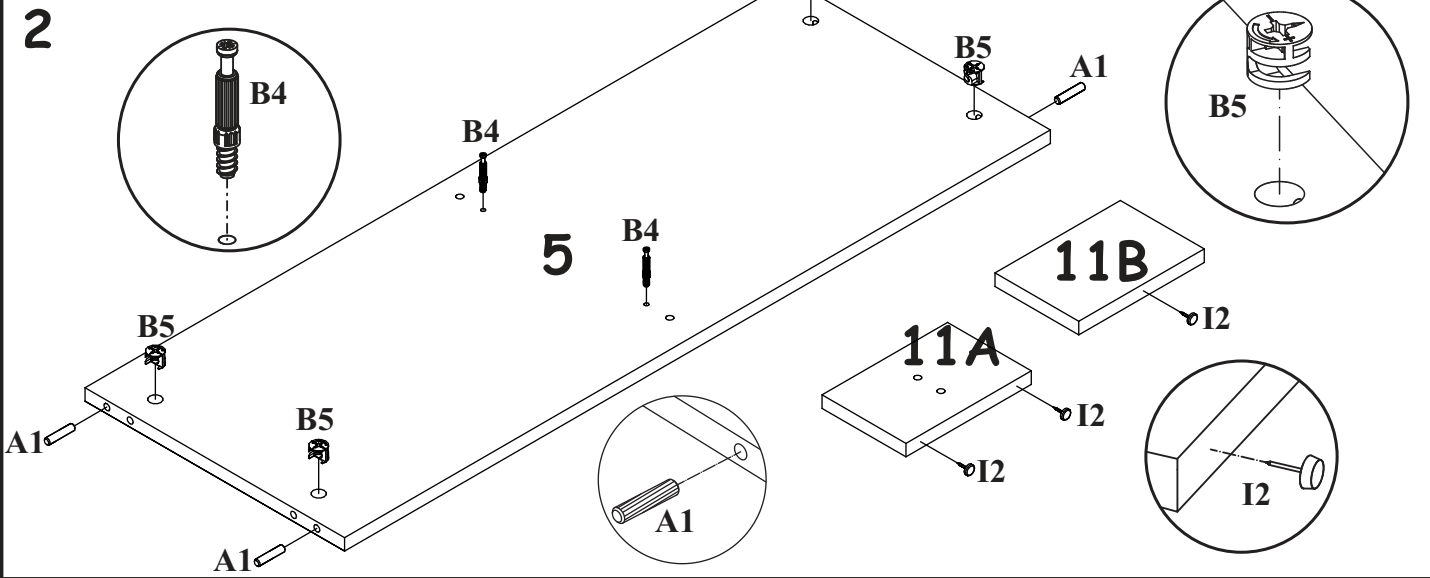

5

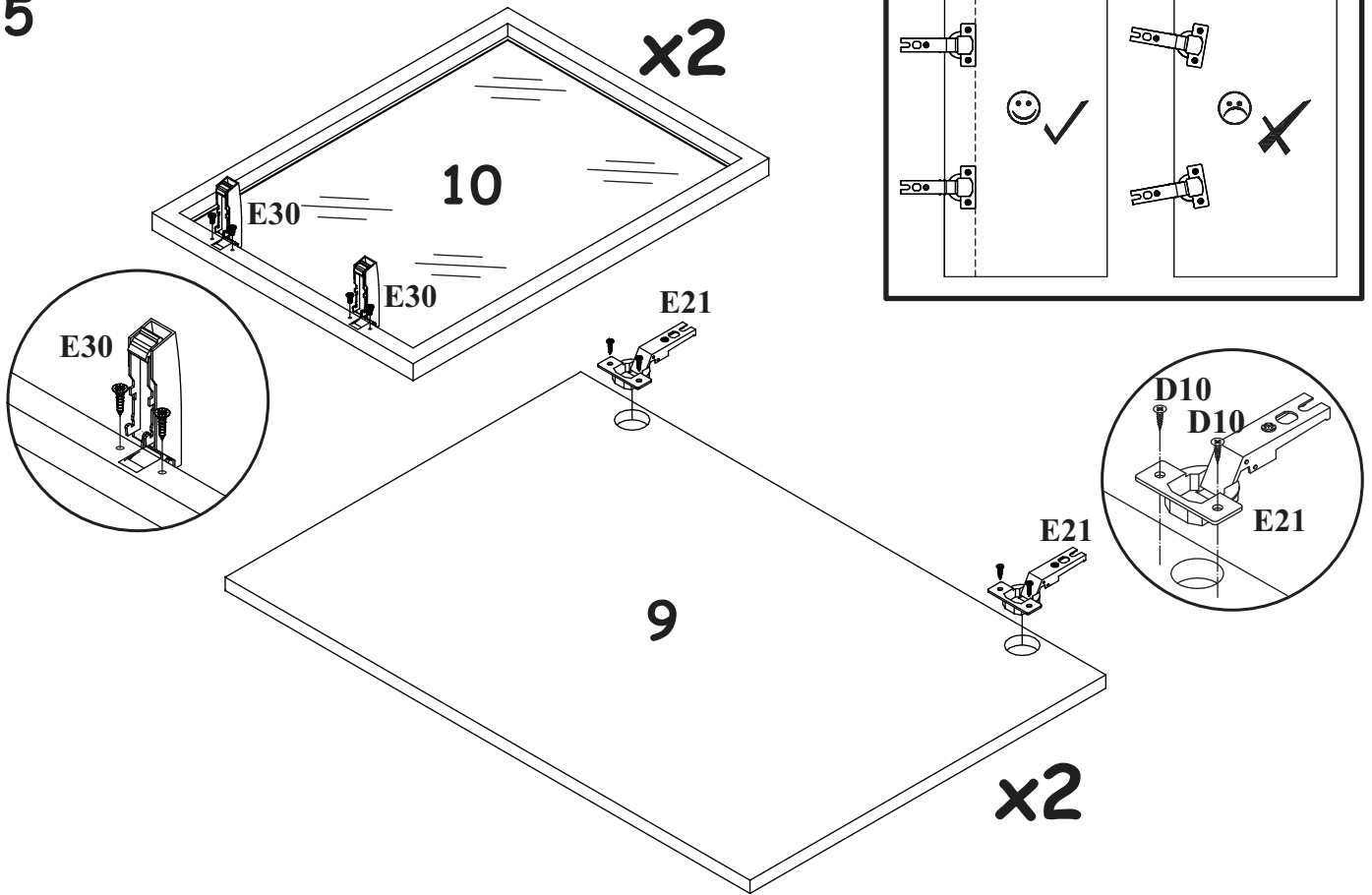

6

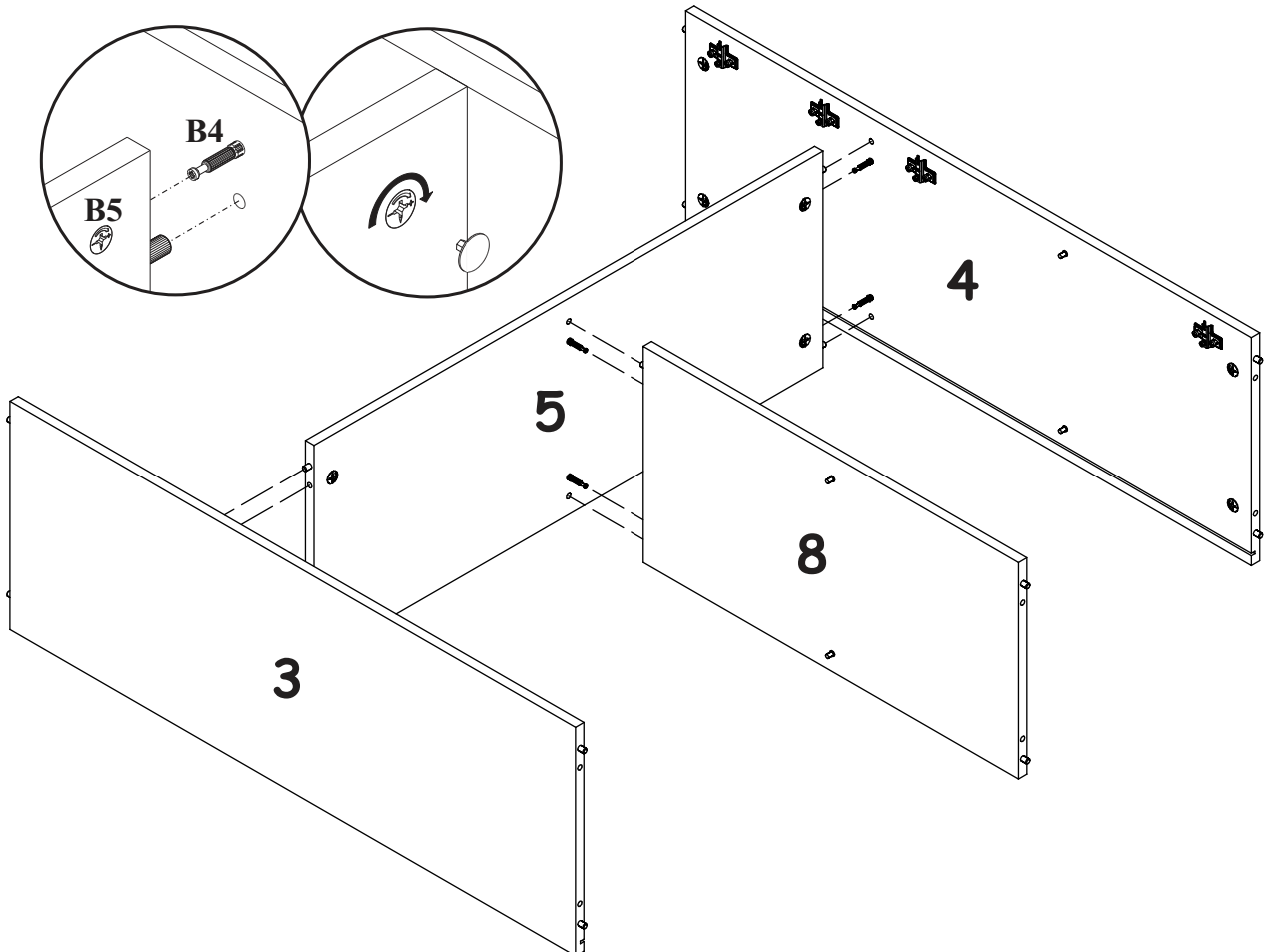

7

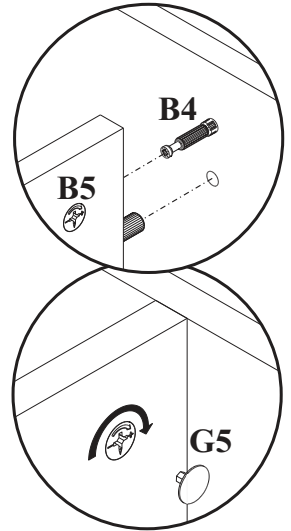
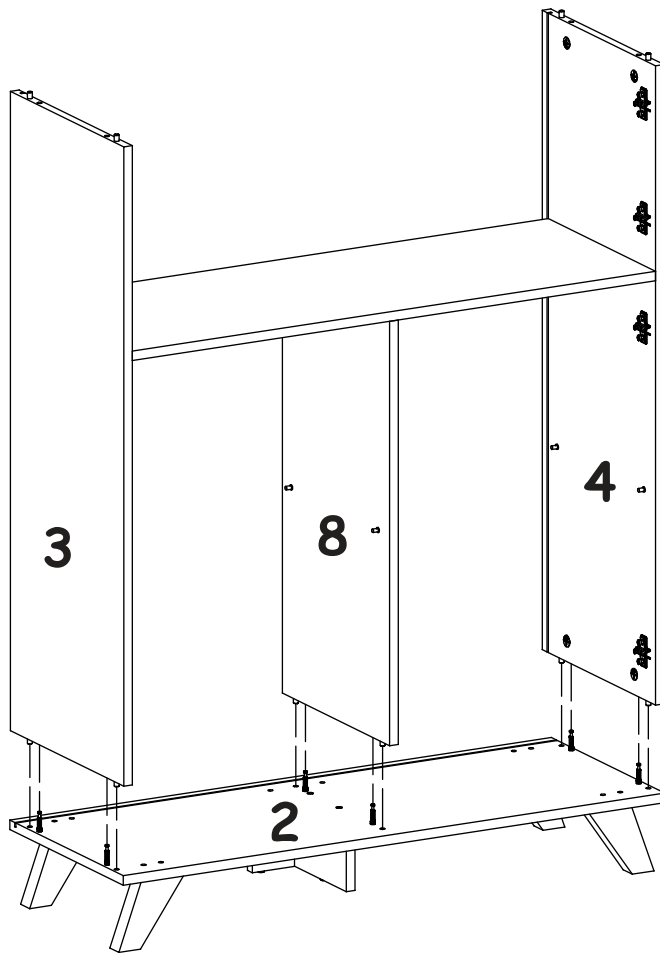

8

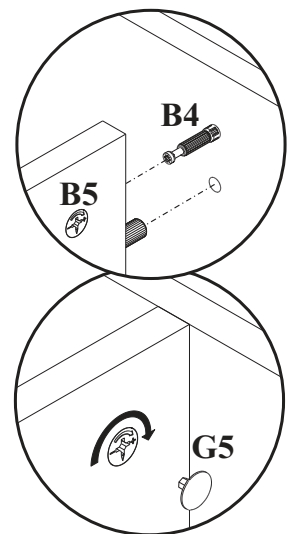
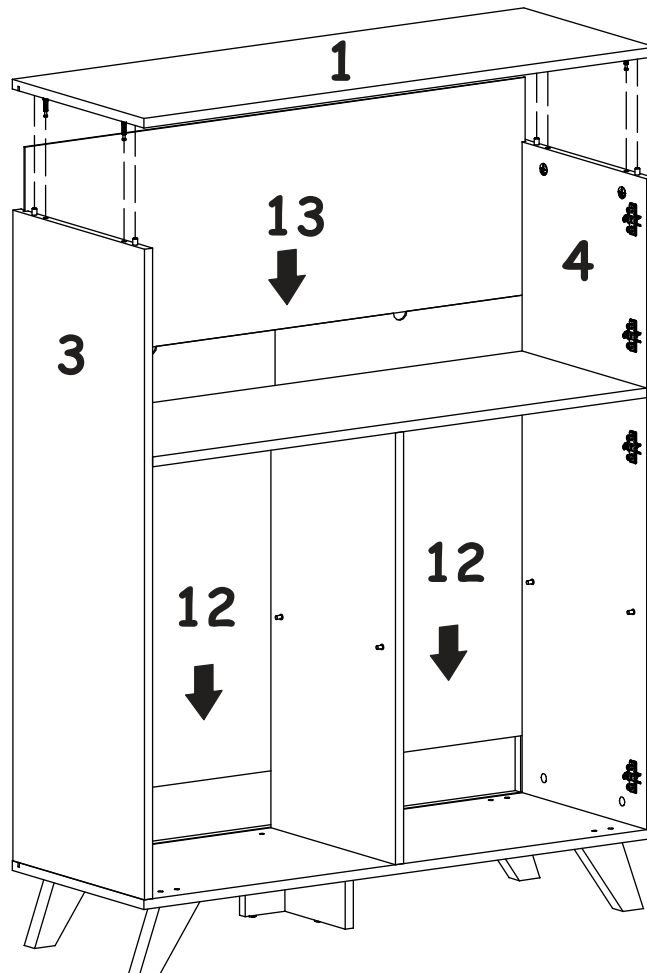

9

X=Y \uparrow 90°

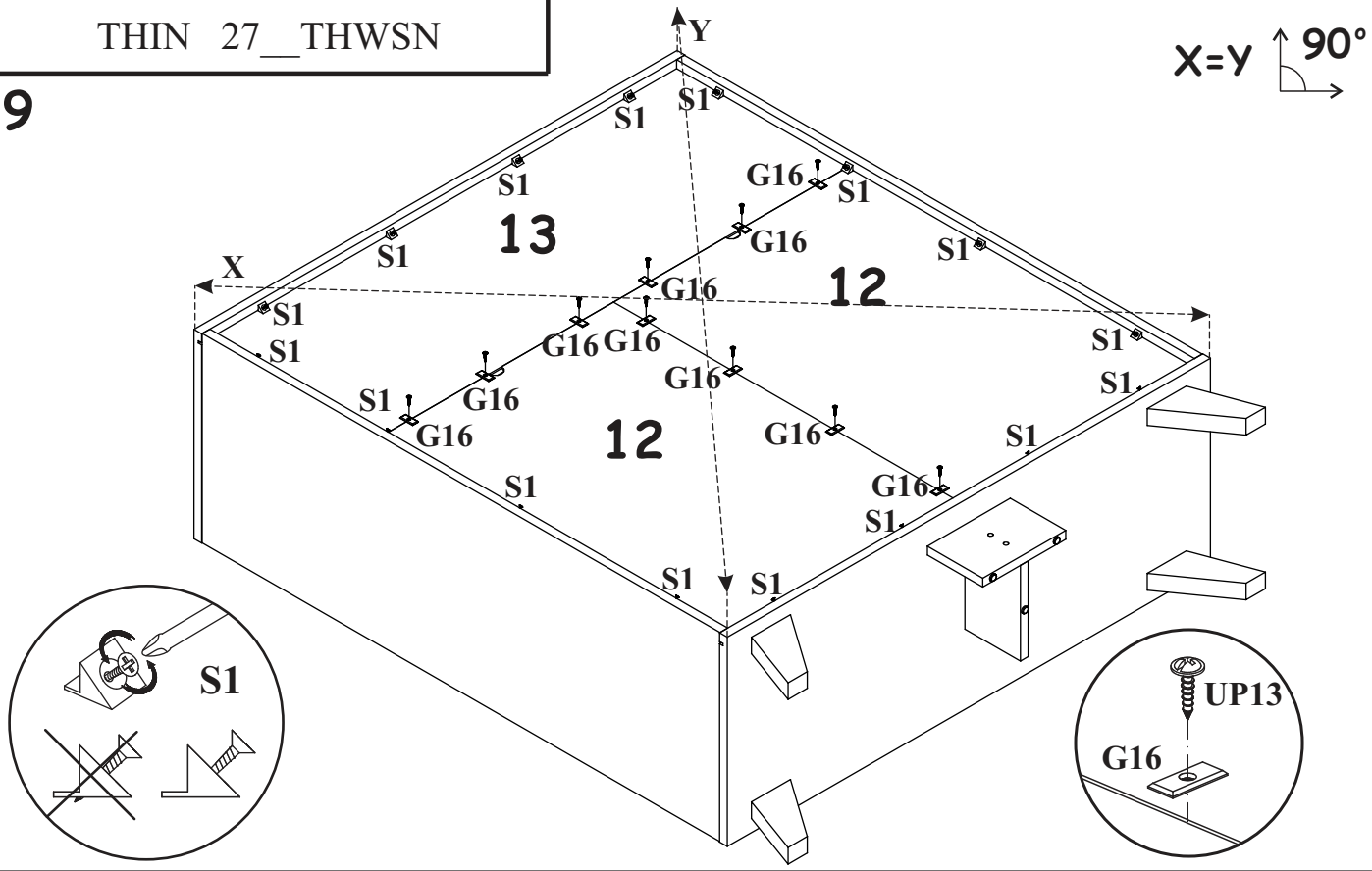

10

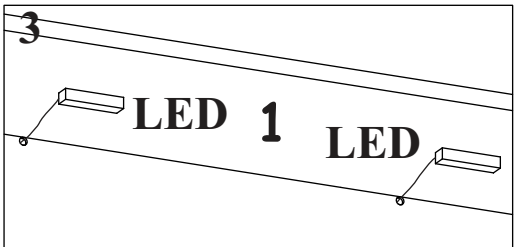
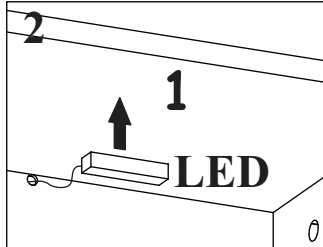
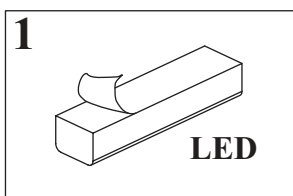
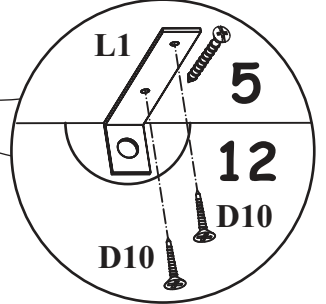
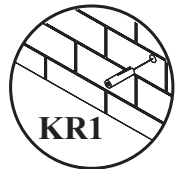
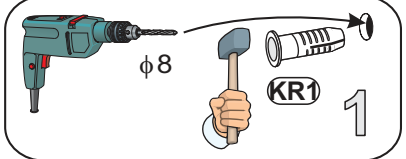
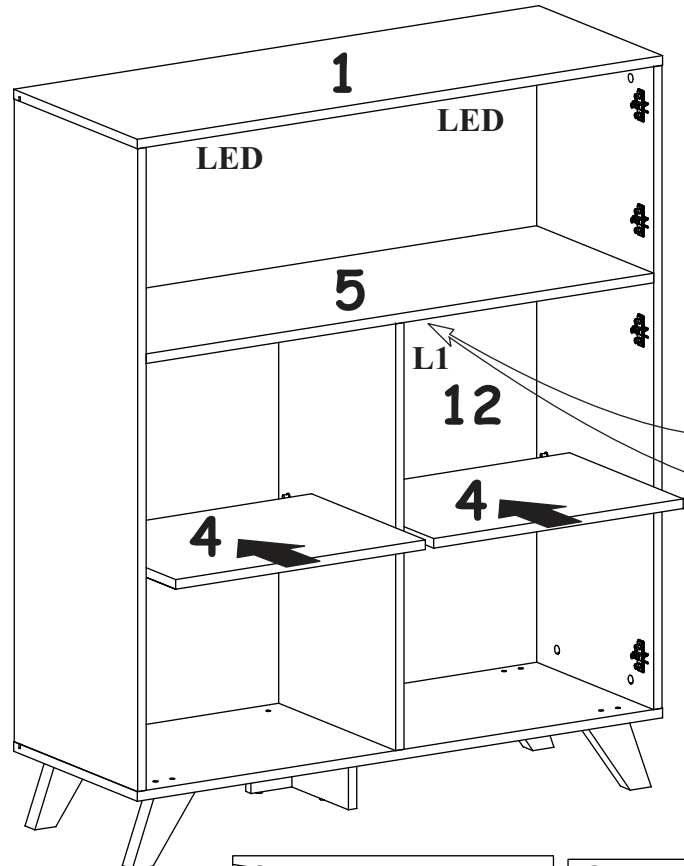
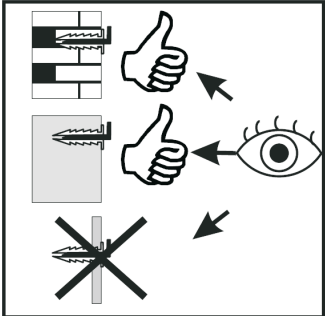

11

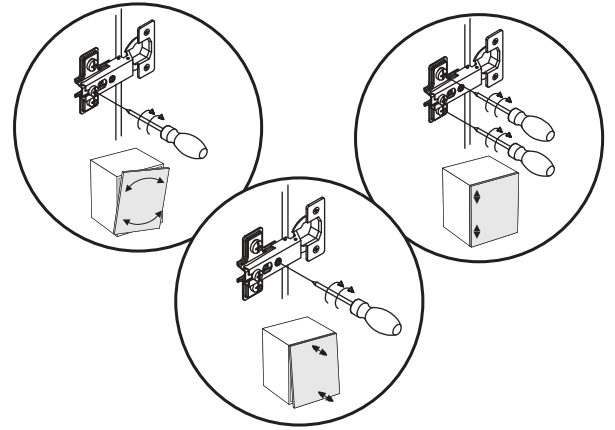
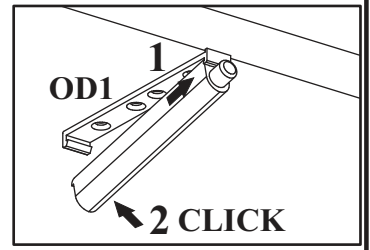
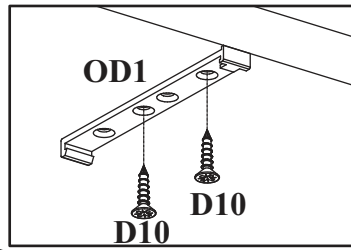
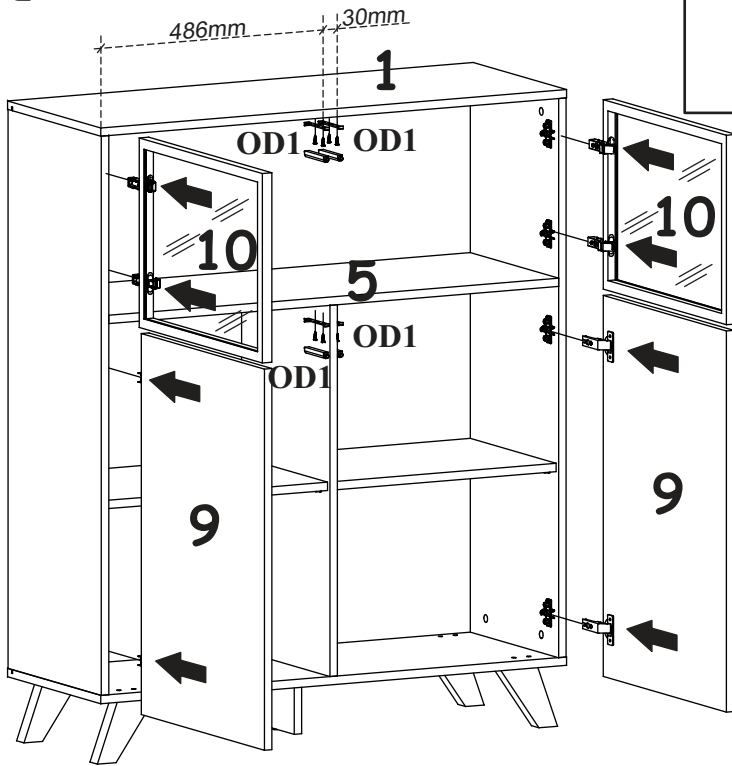

12

