

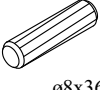

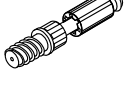







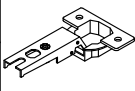
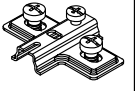

90 min

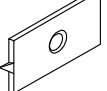
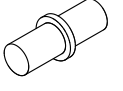
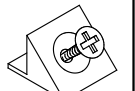
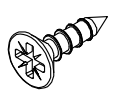
A1 X16  ø8x36	B4 X14 	B5 X14  ø15x12	P3 X2 	G5 X14 	D11 X6  USØ3,5x25
E1 X6  H=0	E2 X6  H=0	ST2 X6 	D9 X8  USØ3x20	G16 X8 	G7 X16 
S1 X16 	D10 X16  USØ3,5x13	G2 X1 	UP13 X18  UPØ3x16	G20 X4 	
KR1 X1 	L1 X1 	P2 X18 	T2 X1  + 20x14		

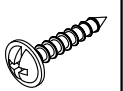
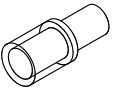
ABW ONTARIO I
ABW ONTARIO II

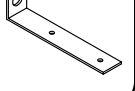
TYPE-40

24...O1
24...O2

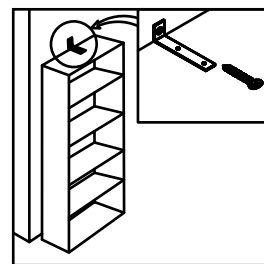
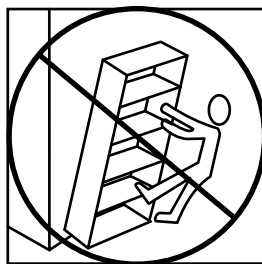
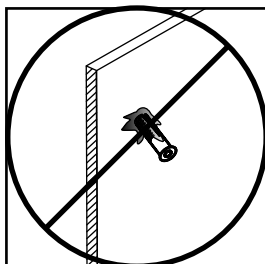
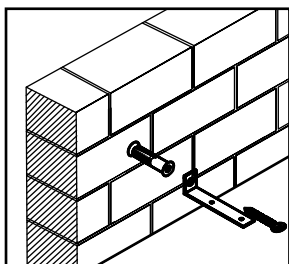
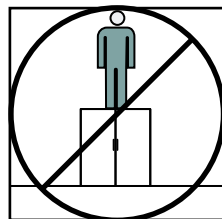
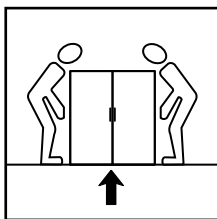
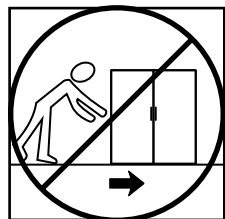
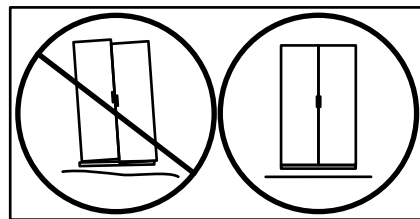
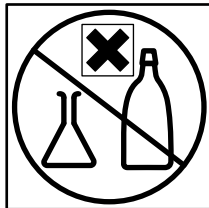
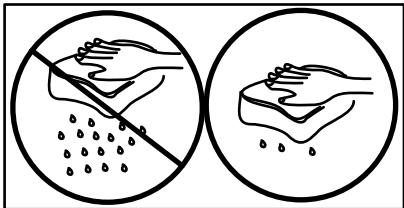
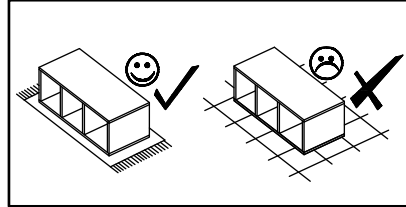
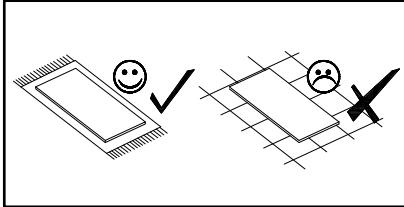
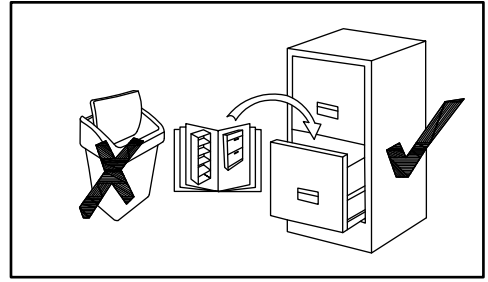
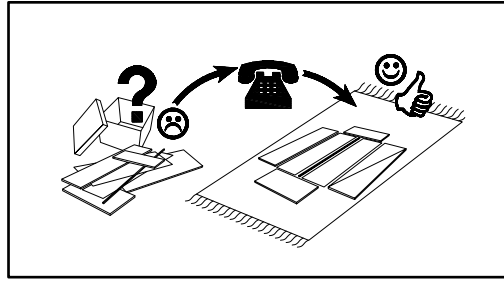
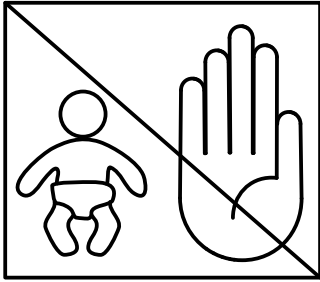

ABW ONTARIO I
ABW ONTARIO II

TYPE-40

24....O1
24....O2

1

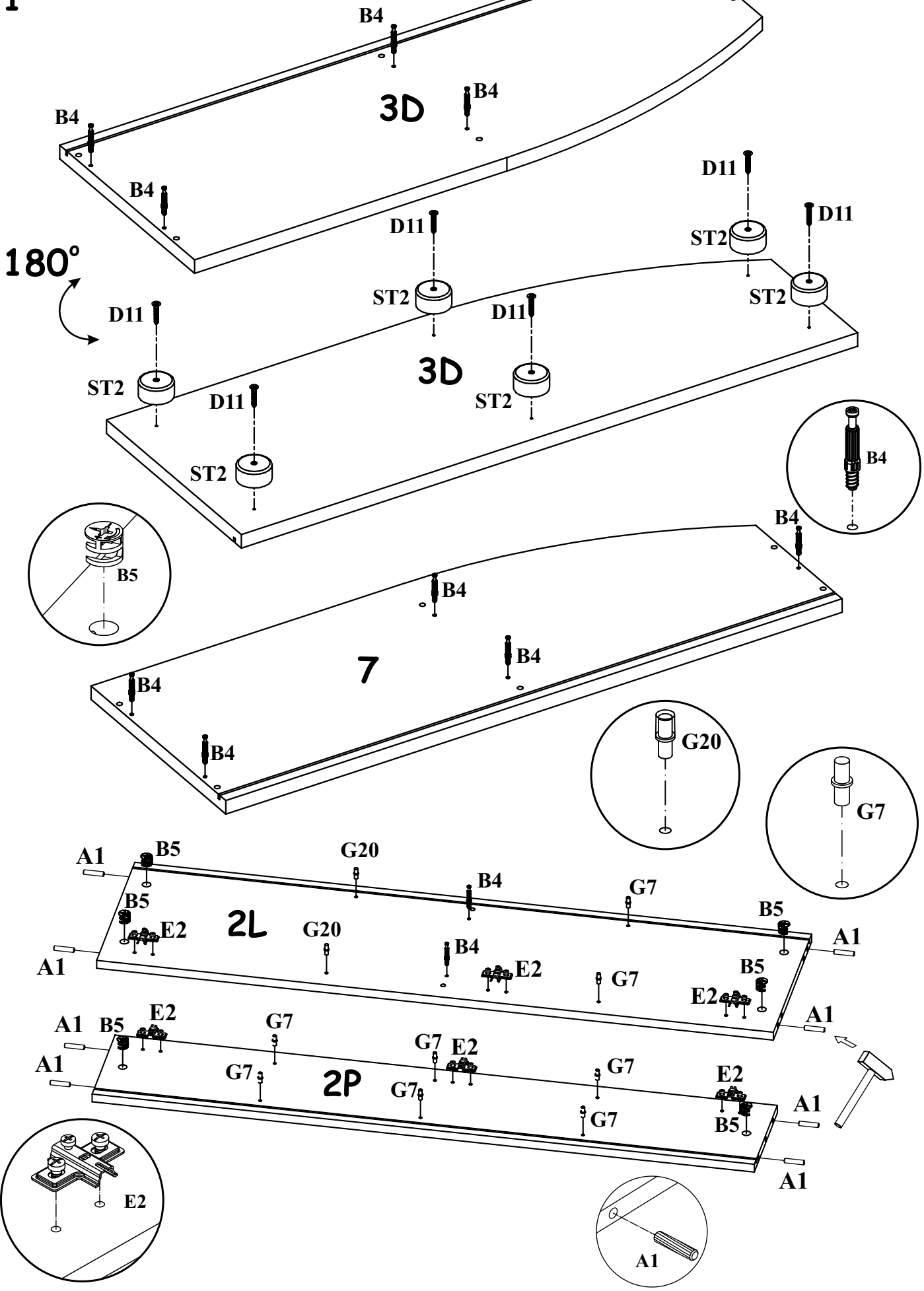

ABW ONTARIO I 24...O1
 ABW ONTARIO II 24...O2

TYPE-40

2

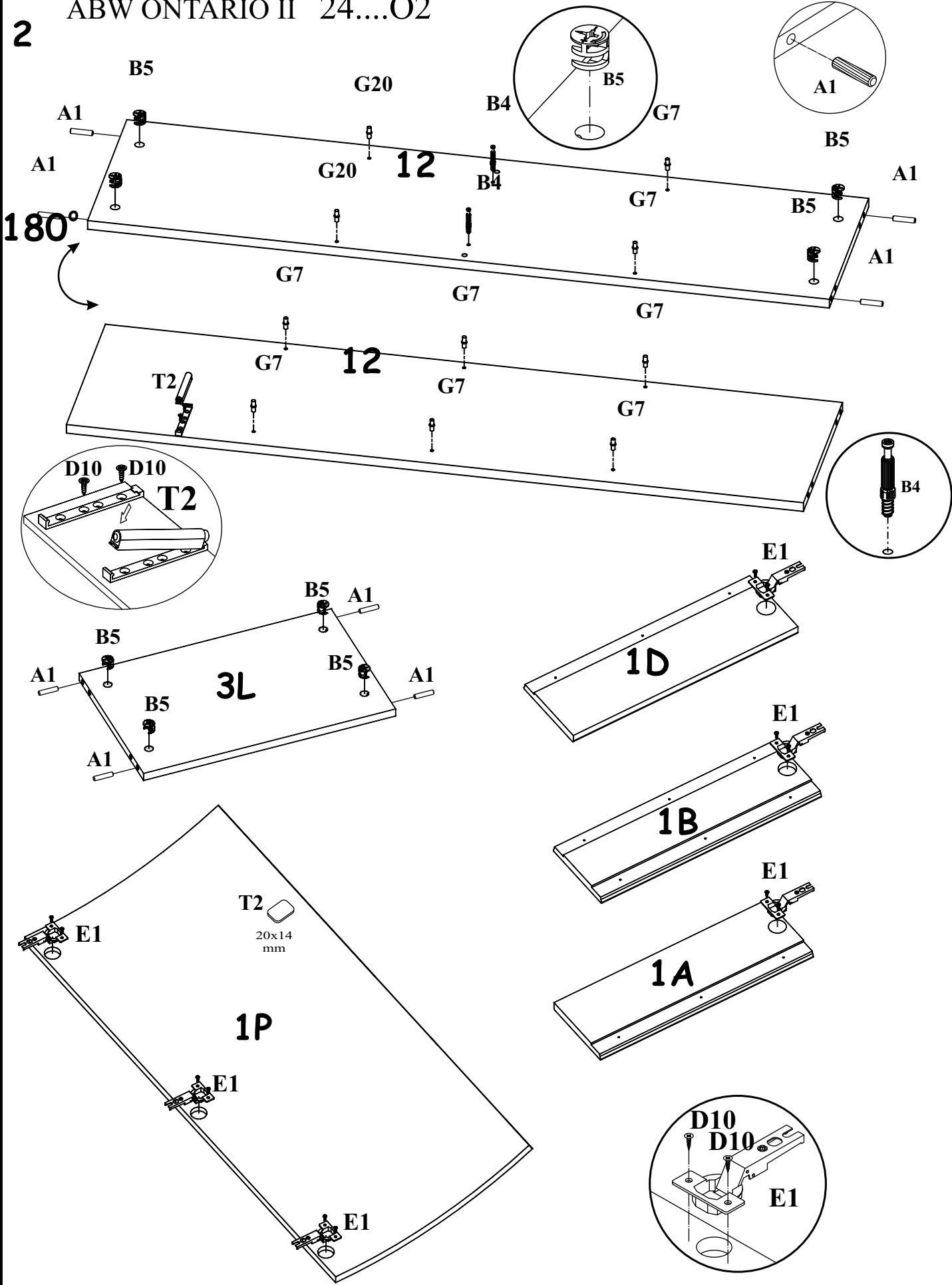

ABW ONTARIO I 24....O1
ABW ONTARIO II 24....O2

TYPE-40

3

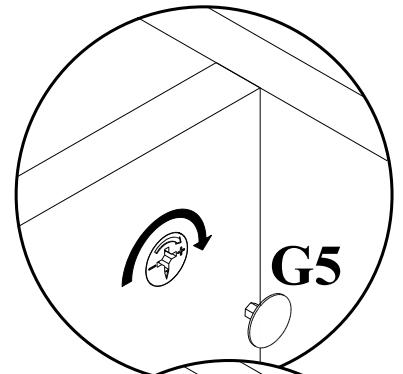
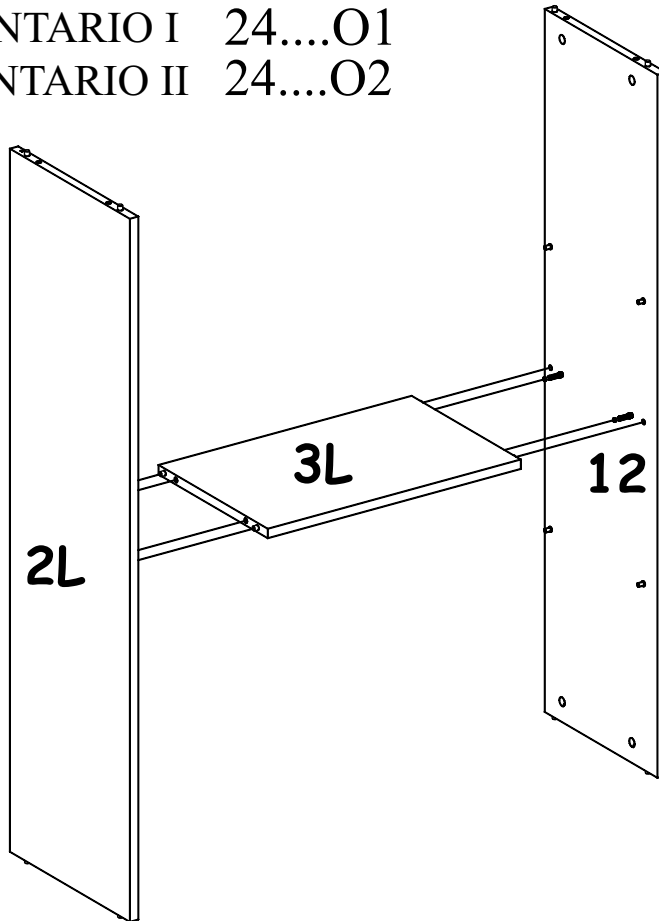

4

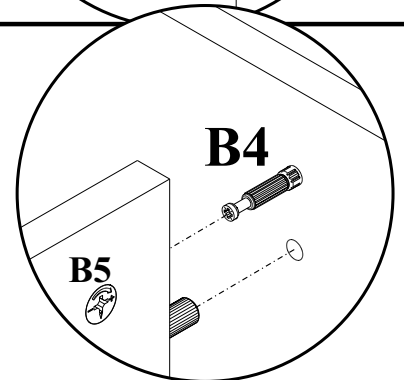
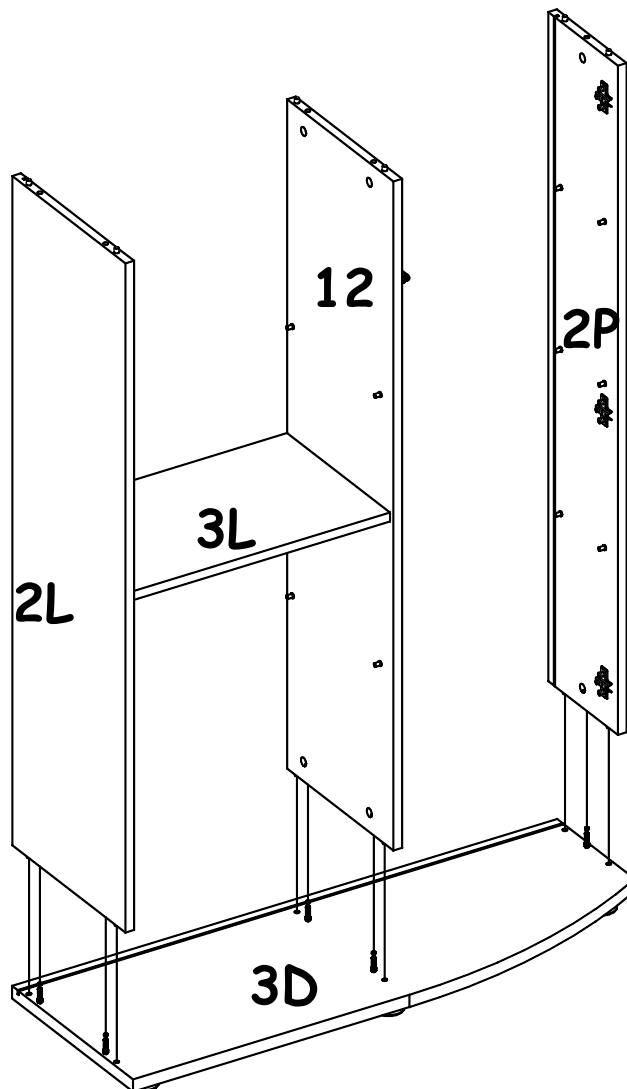

ABW ONTARIO I 24...01
ABW ONTARIO II 24...02

TYPE-40

5

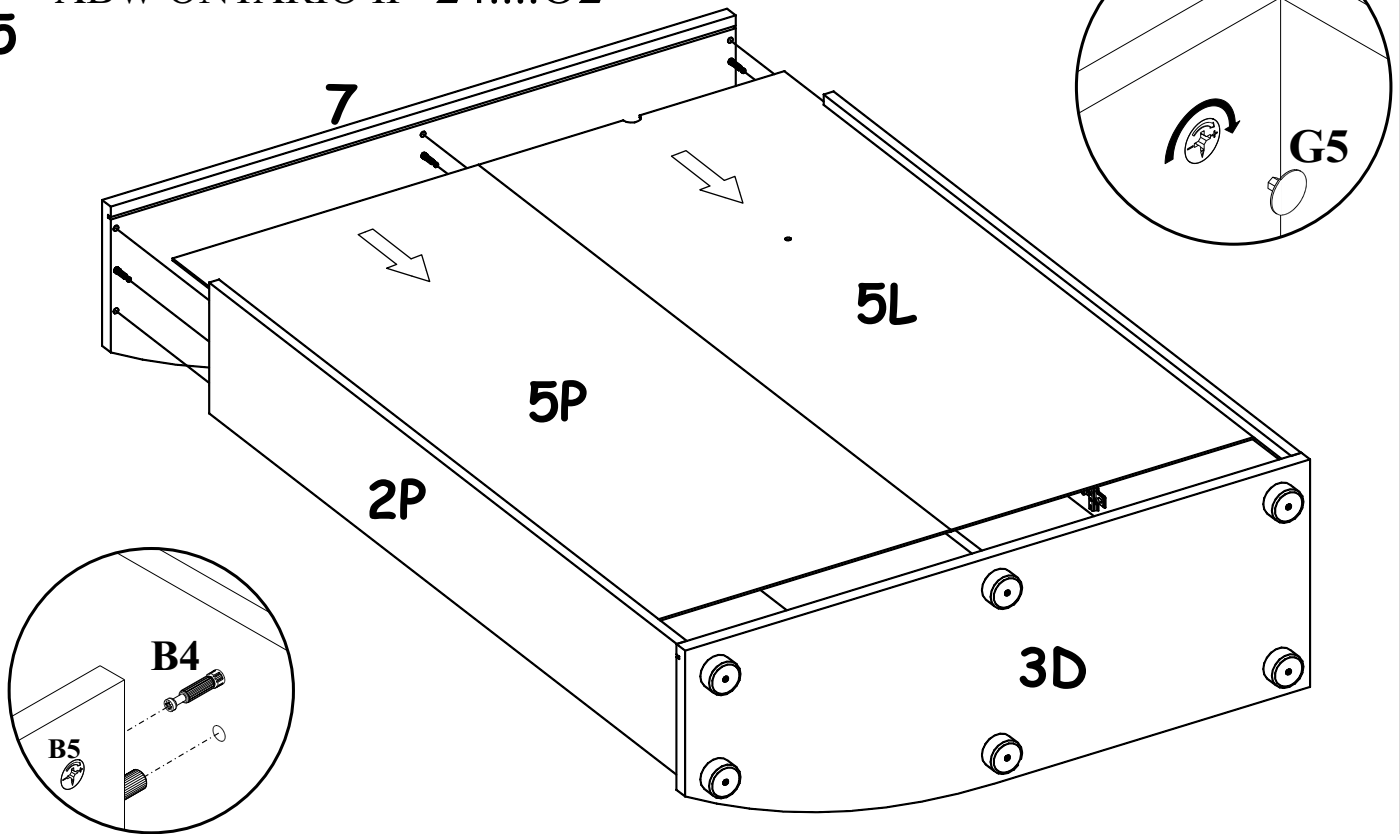

6

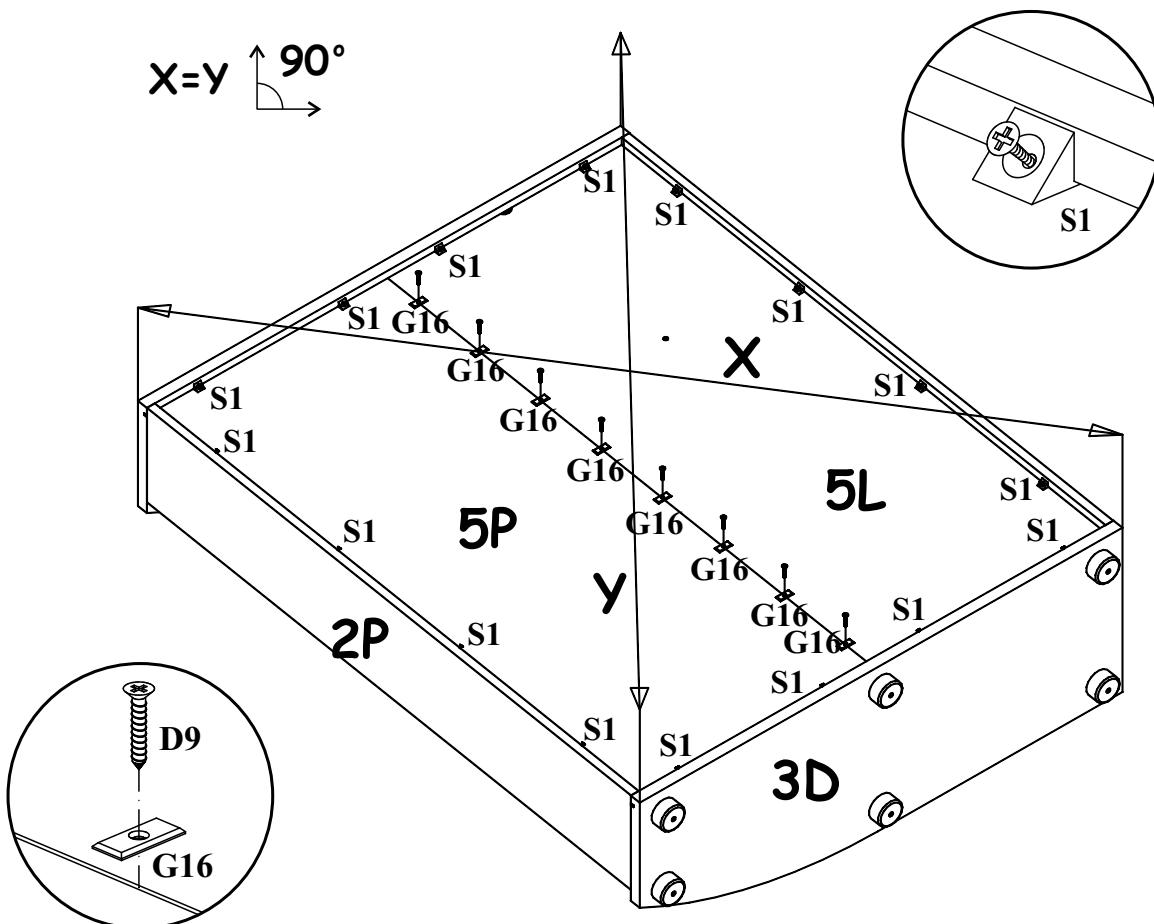

ABW ONTARIO I 24...O1
 ABW ONTARIO II 24...O2

TYPE-40

7

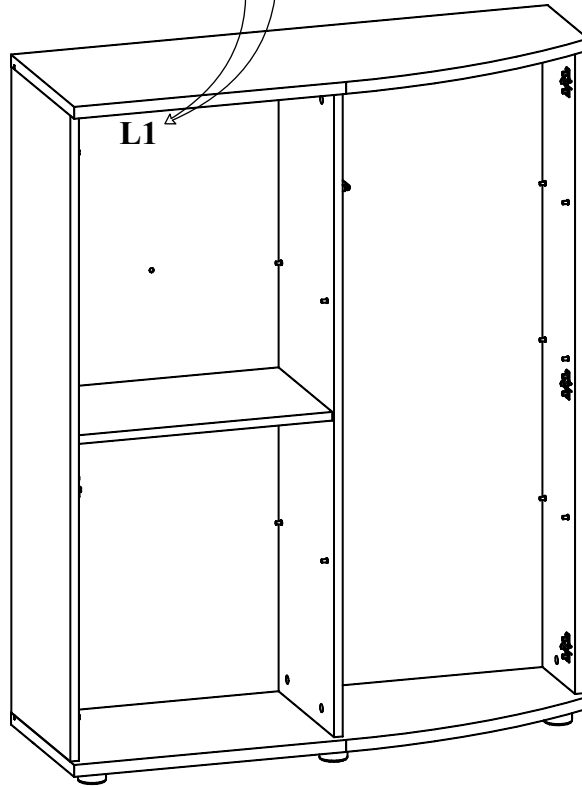
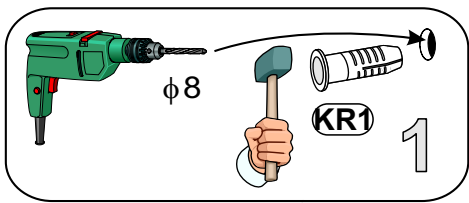
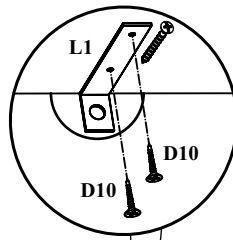
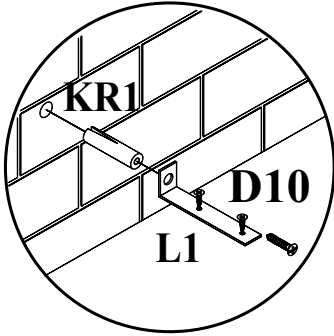

8

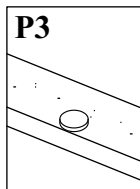
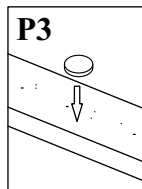
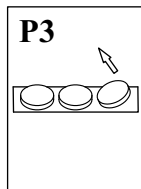
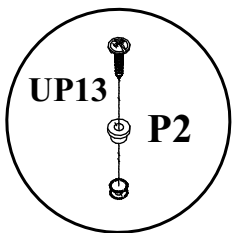
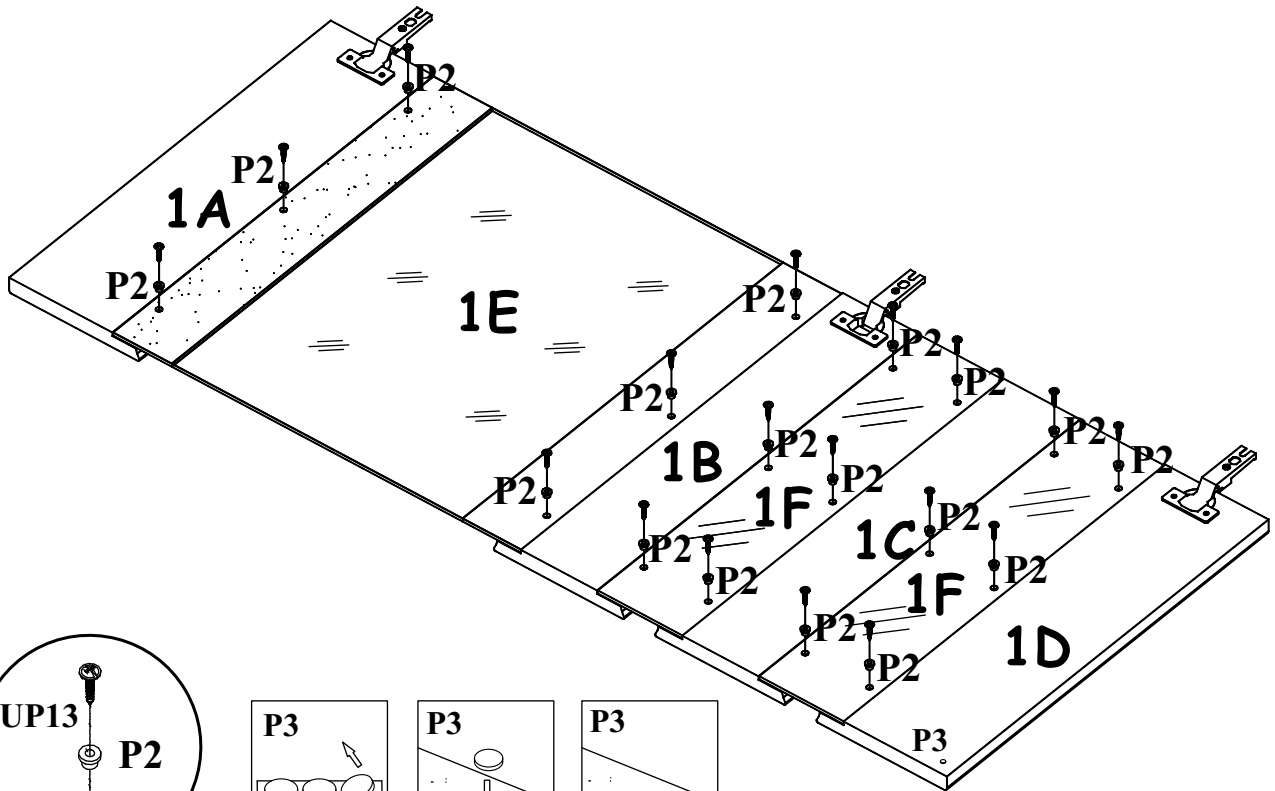

9

