

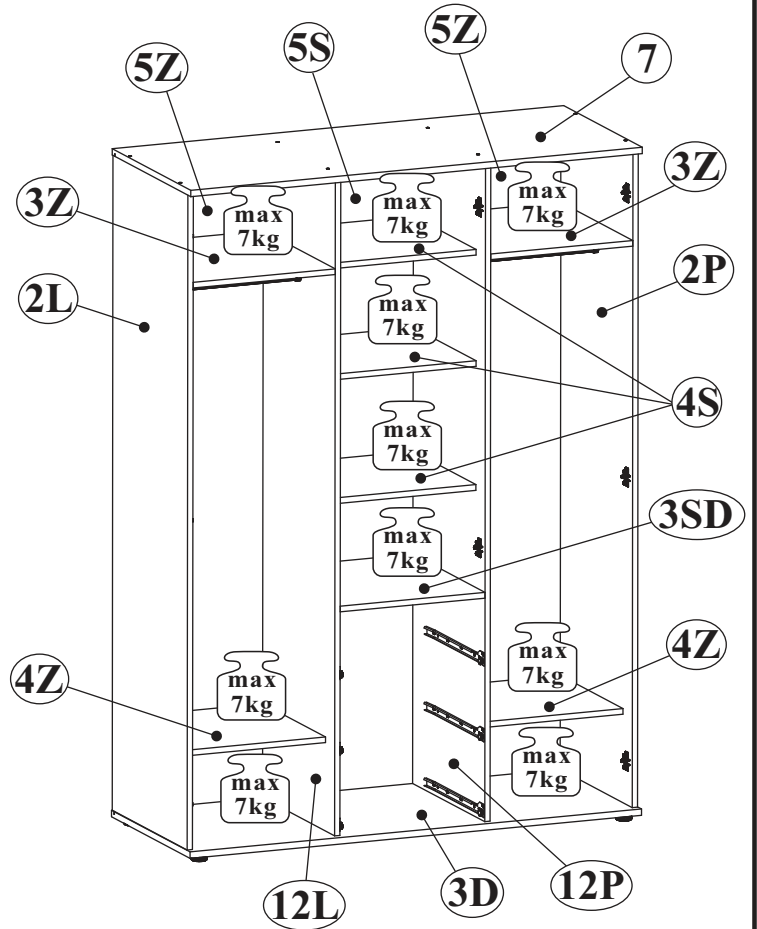

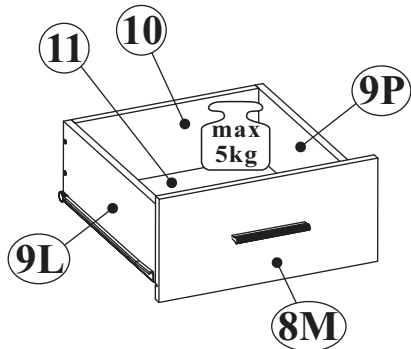

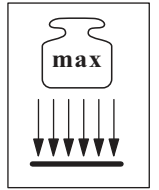

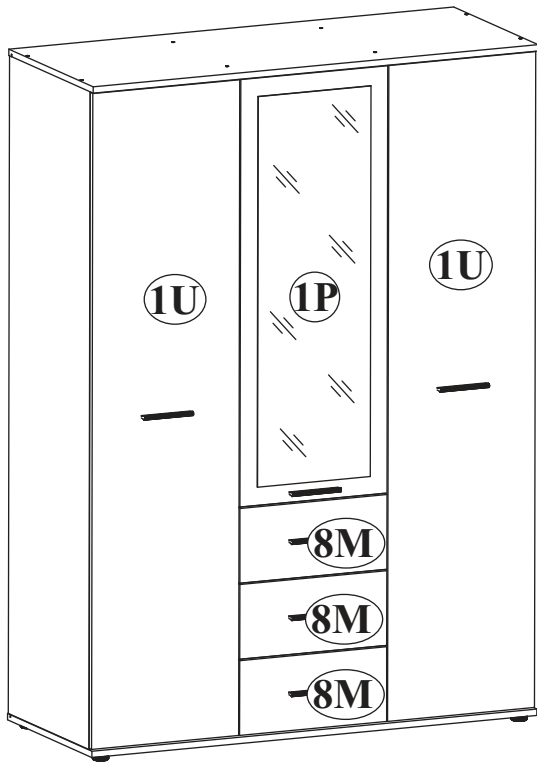

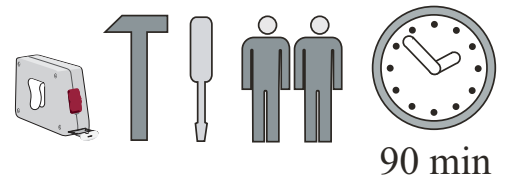

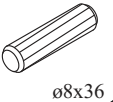
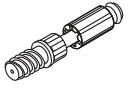
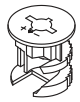

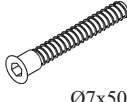
DINO TYP 1

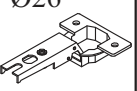
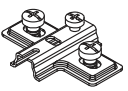
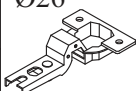
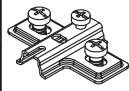
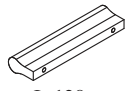
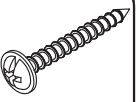
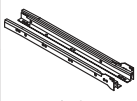

NO	Dim.			Col.-No	Qty
1U	1844	446	16	2	2
1P	1202	446	19	2	1
2L	1850	525	16	3	1
2P	1850	525	16	3	1
12L	1850	505	16	3	1
12P	1850	505	16	3	1
3D	1350	550	18	1	1
3SD	433	505	16	1	1
3Z	425	505	16	1	2
4Z	425	440	16	2	2
4S	433	440	16	1/2	3
5Z	1861	439	3	2	2
5S	1861	449	3	2	1
7	1350	550	18	1	1
8M	446	210	16	2	3
9L	450	160	16	1	3
9P	450	160	16	1	3
10	375	140	16	1	3
11	385	455	16	1	3

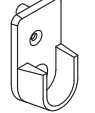
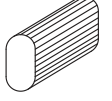

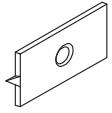
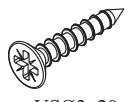
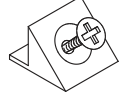
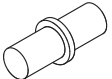

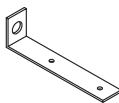
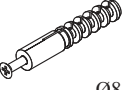
DINO TYP 1

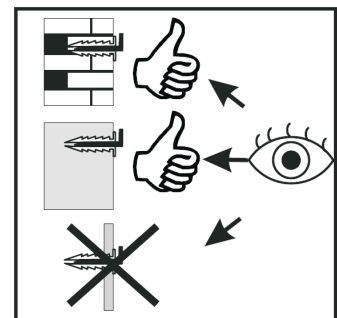
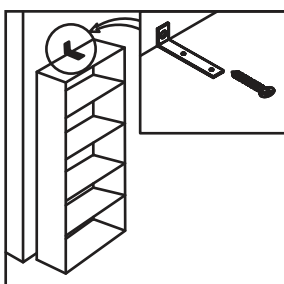
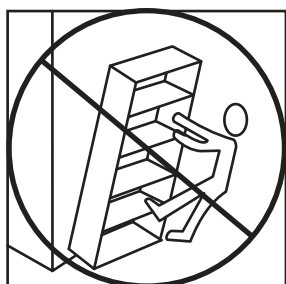
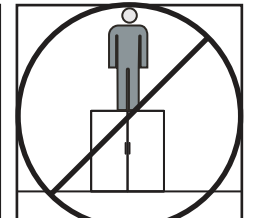
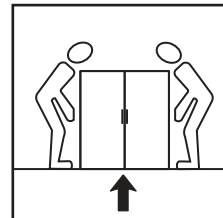
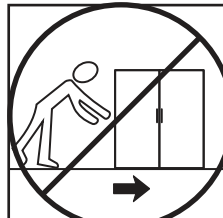
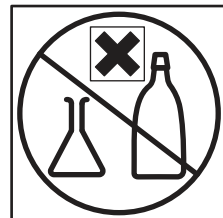
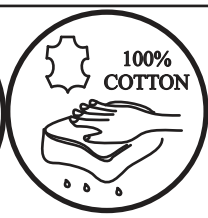
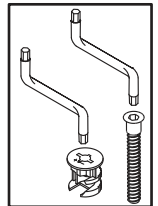
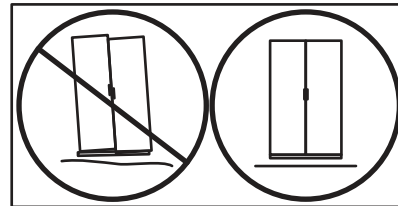
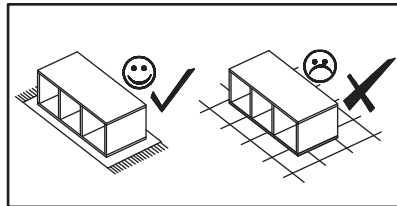
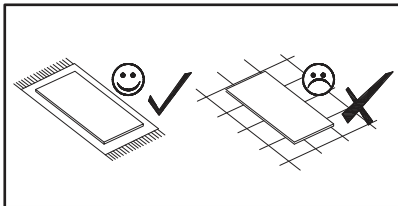
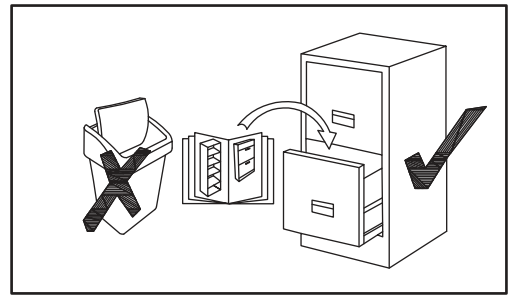
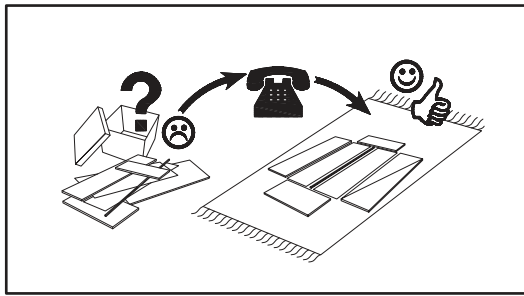
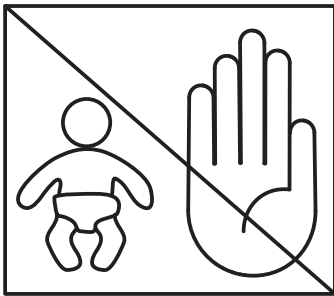
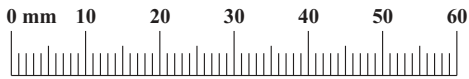
A1 x40  Ø8x36	B4 x18 	B5 x18  Ø15x12	G5 x18 	B11 x28  Ø7x50	G4 x28 
E1 x6 Ø26 H=0 	E2 x6 H=0 	E3 x2 Ø26 H=8 	E4 x2 H=2 	KL x6 L-128mm. 	UP6 x12 UPØ4x30 
H5 x3 L-450mm. 	D27 x12 ESØ6x8 	B3 x12 Ø1,4x25 	D10 x40 USØ3,5x13 	G10 x4 	C5 x2 L-416mm 
I11 x6 Ø45, h=15 	D11 x6 USØ3,5x25 	G16 x24 	D9 x24 USØ3x20 	S1 x16 	G7 x20 
			G2 x1 	L1 x1 	KR1 x1 Ø8 

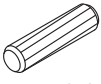
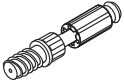
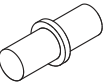
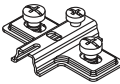

DINO TYP 1

1



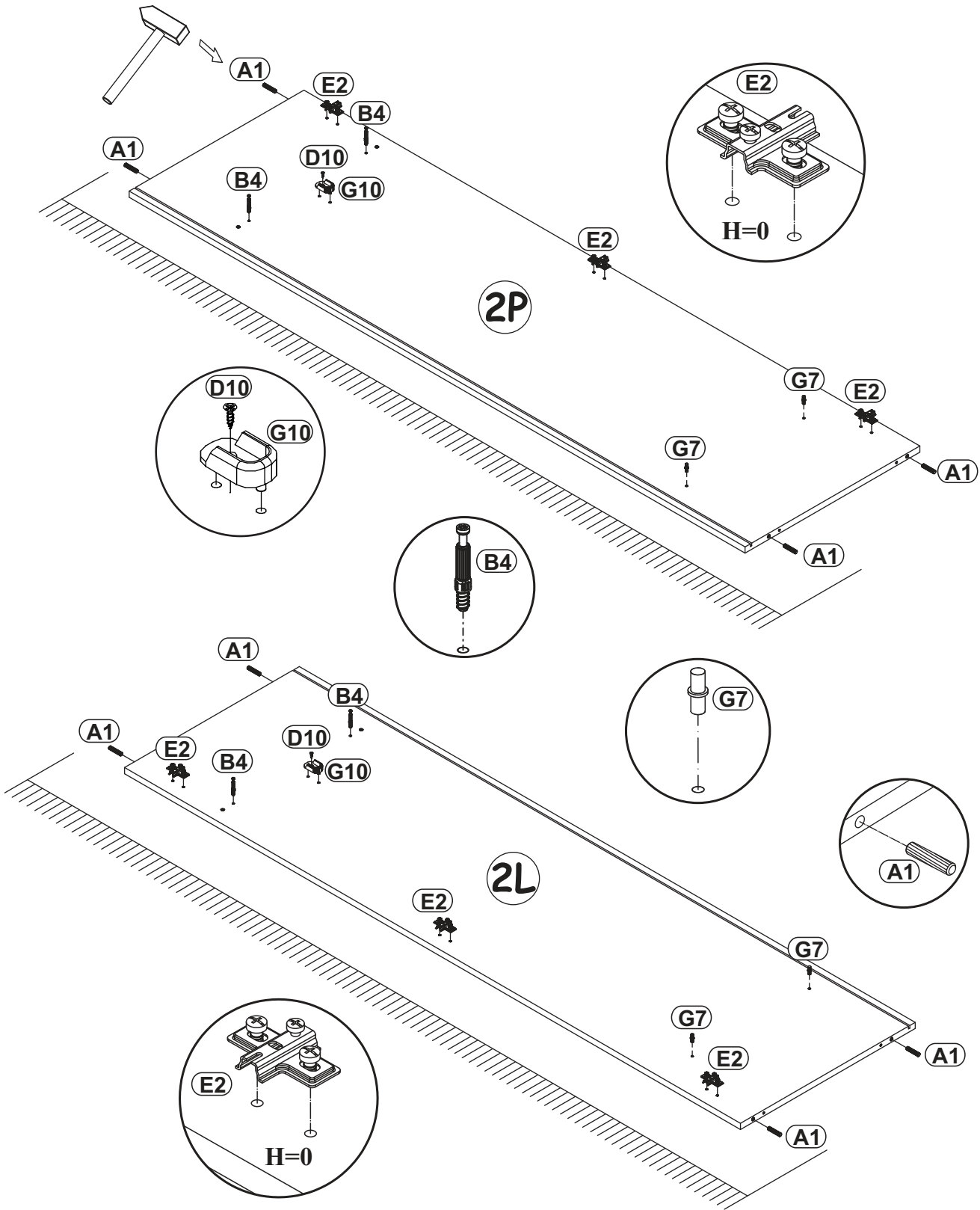

A1		B4		G7	
x8	ø8x36	x4		x4	
E2		G10		D10	
x6	H=0	x2		x2	US03,5x13

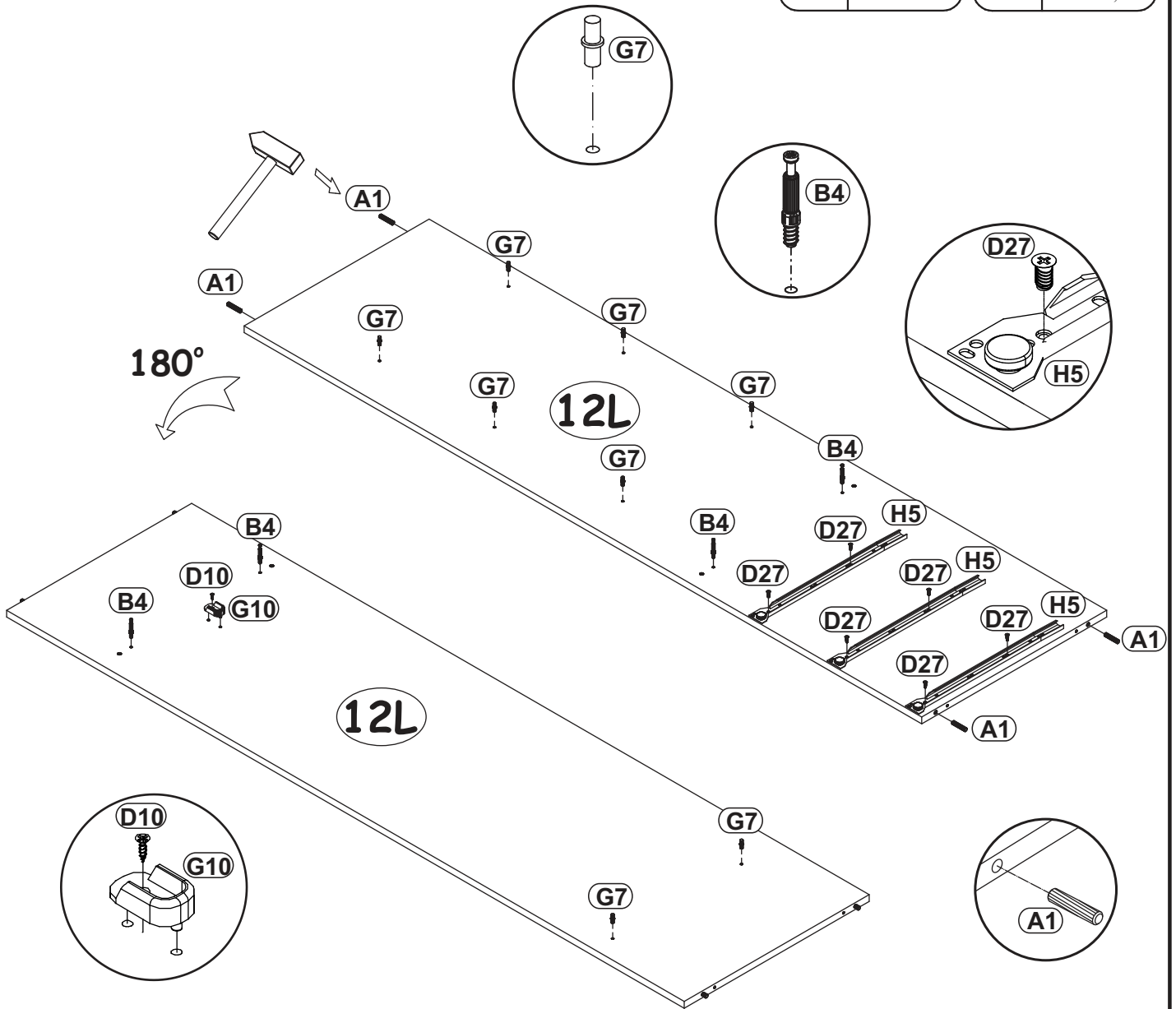
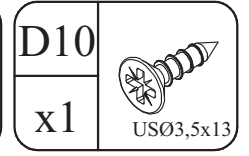
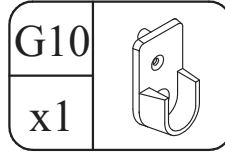
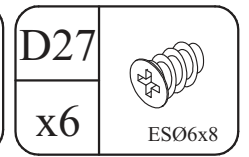
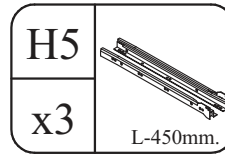
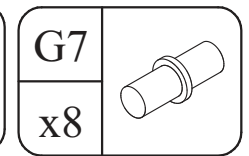
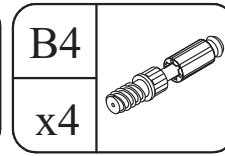
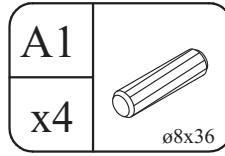

2

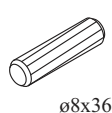
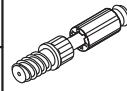
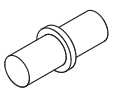
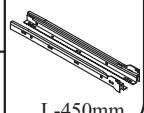

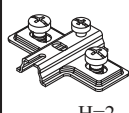
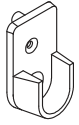
3

A1 x4	 ø8x36	B4 x4		G7 x8	
H5 x3	 L-450mm.	D27 x6	 ESØ6x8	E4 x2	 H=2
G10 x1		D10 x1	 USØ3,5x13		

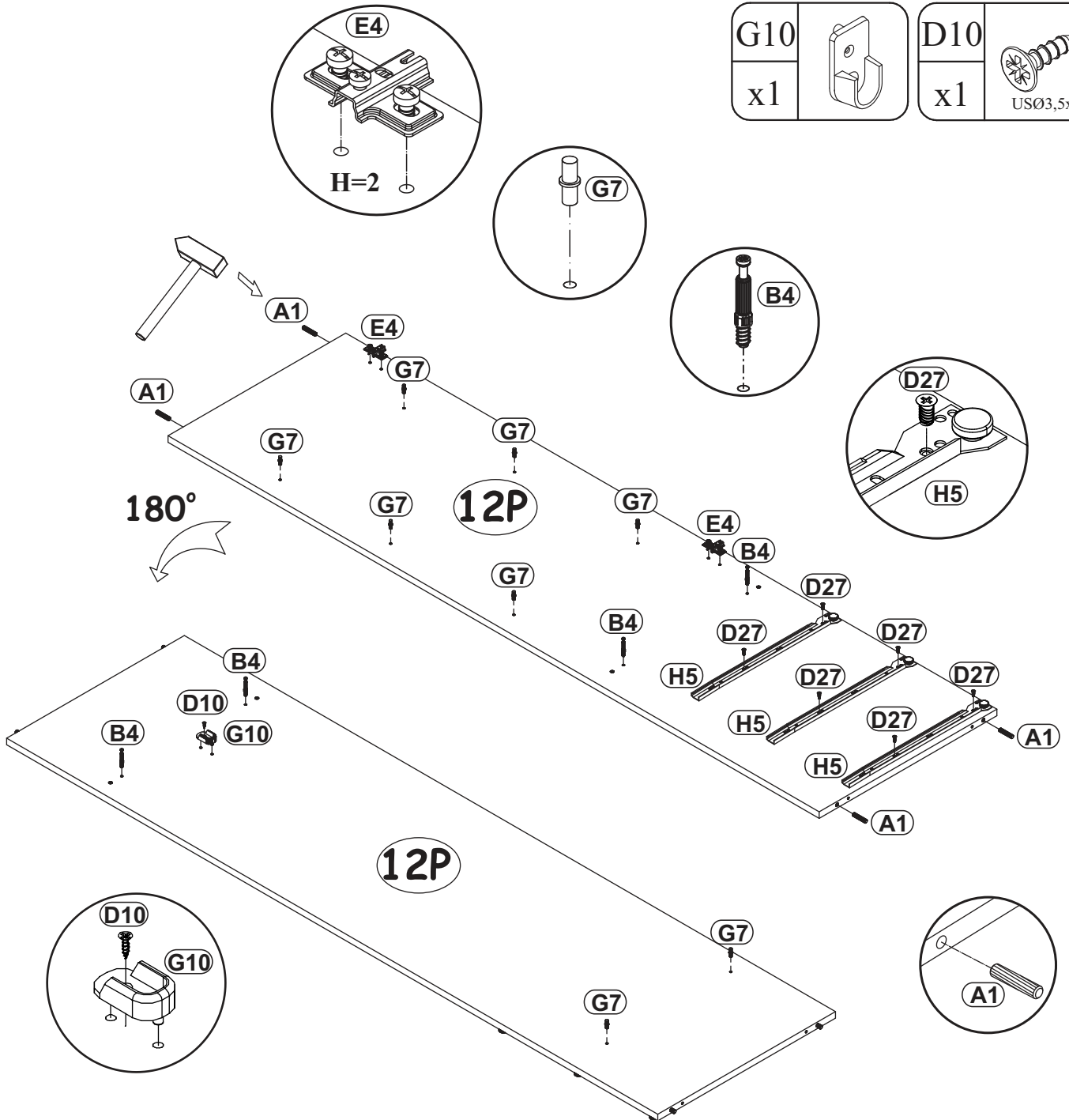

DINO TYP 1

4

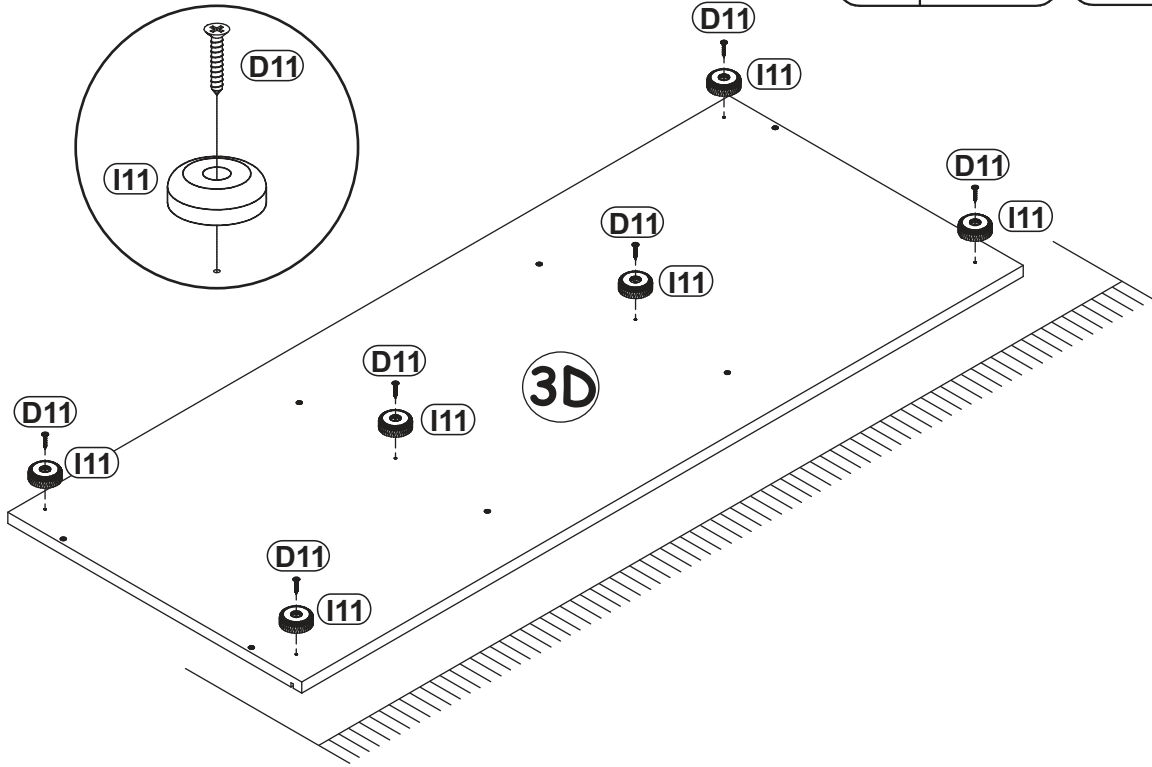

I11		D11	
x6	Ø45, h=15	x6	USØ3,5x25

5

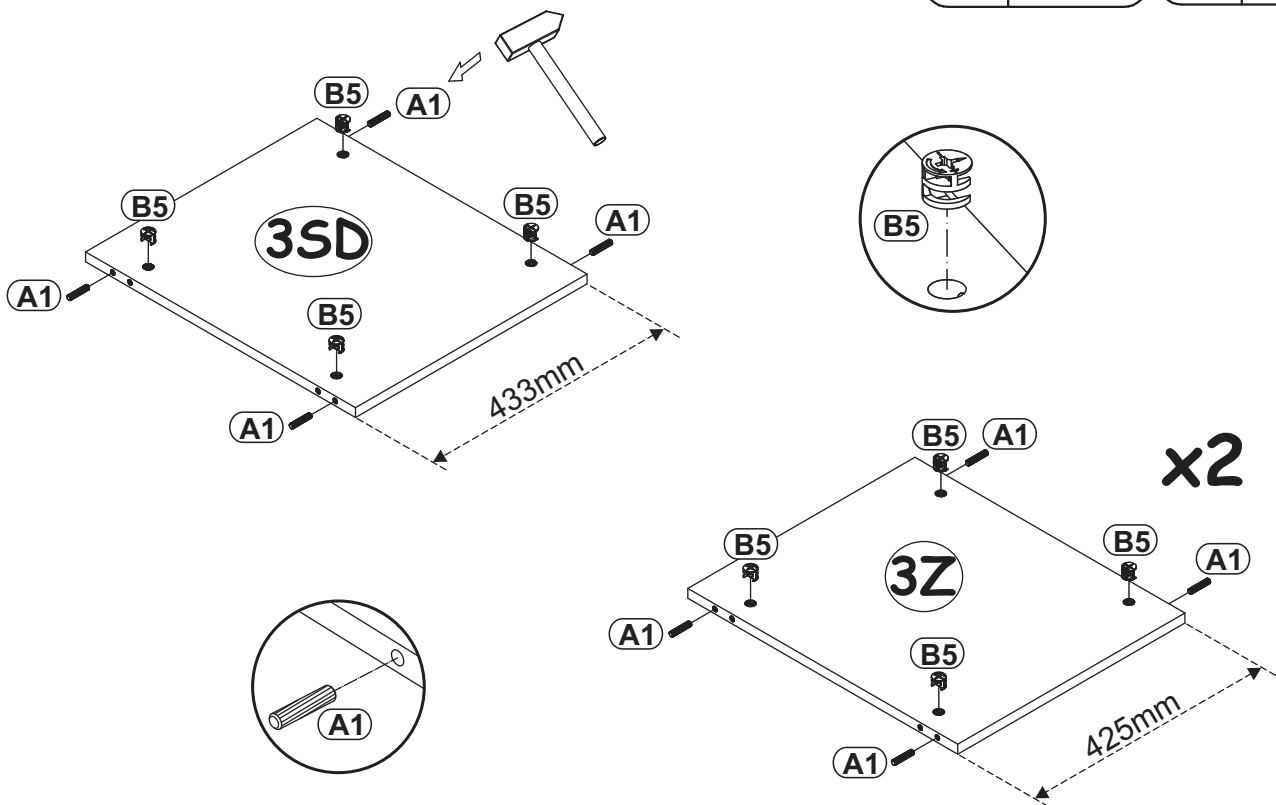

A1		B5	
x12	ø8x36	x12	Ø15x12

DINO TYP 1

6

E1	Ø26
x6	H=0

E3	Ø26
x2	H=8

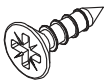
D10	
x16	USØ3,5x13

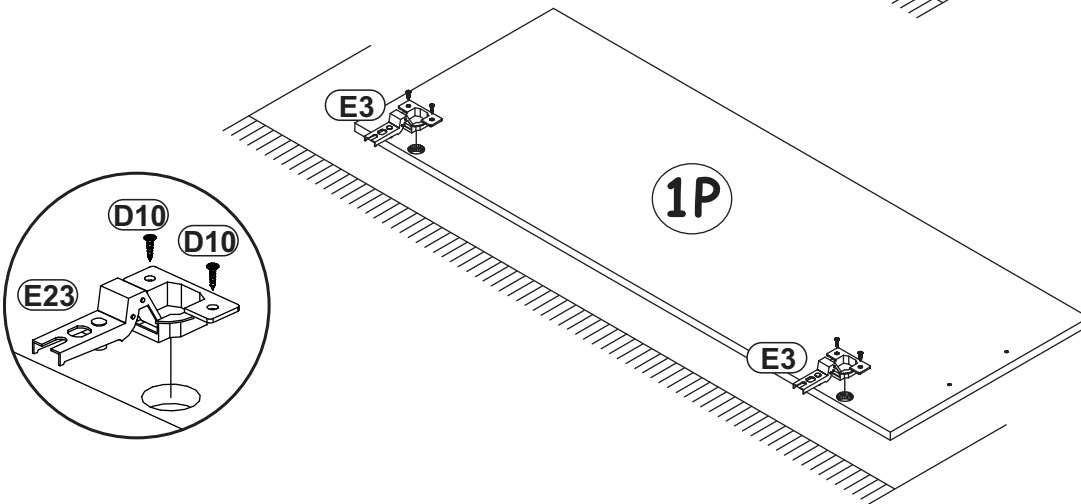
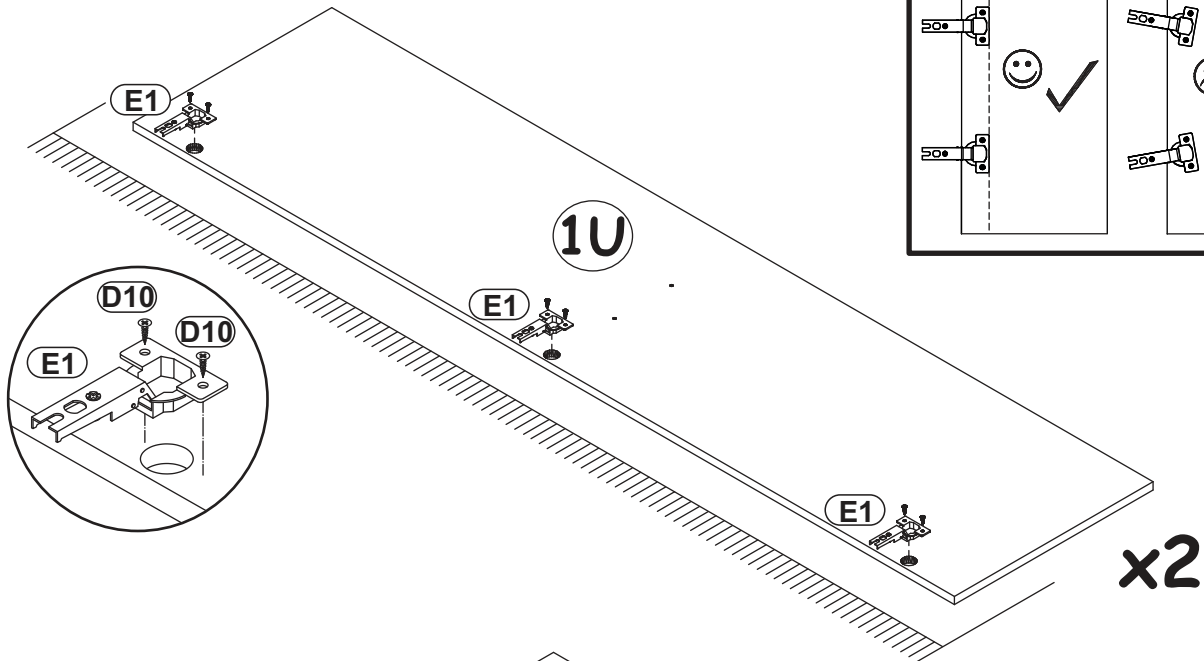
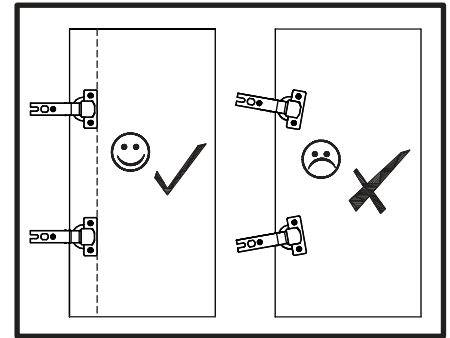

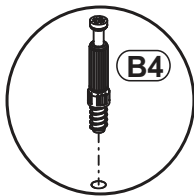

7

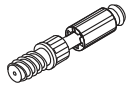

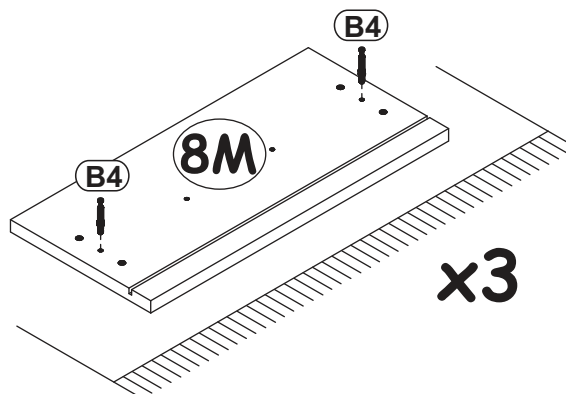
B4	
x6	



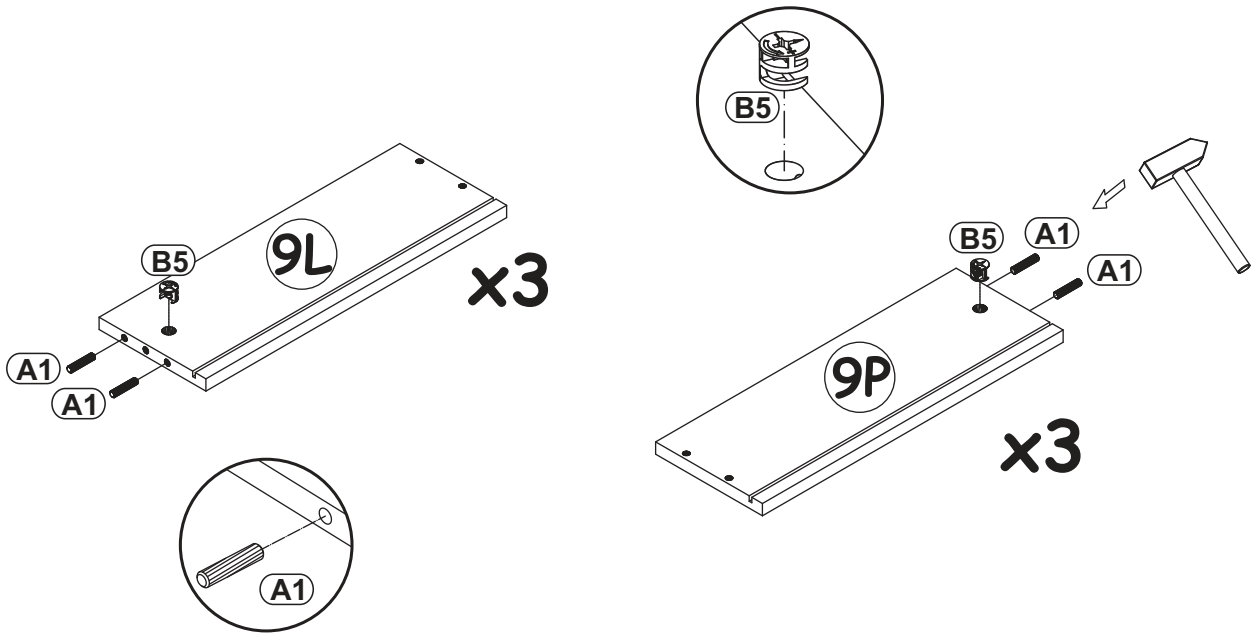

8

A1		B5	
x12	ø8x36	x6	Ø15x12



9

B11		G4	
x12	Ø7x50	x12	

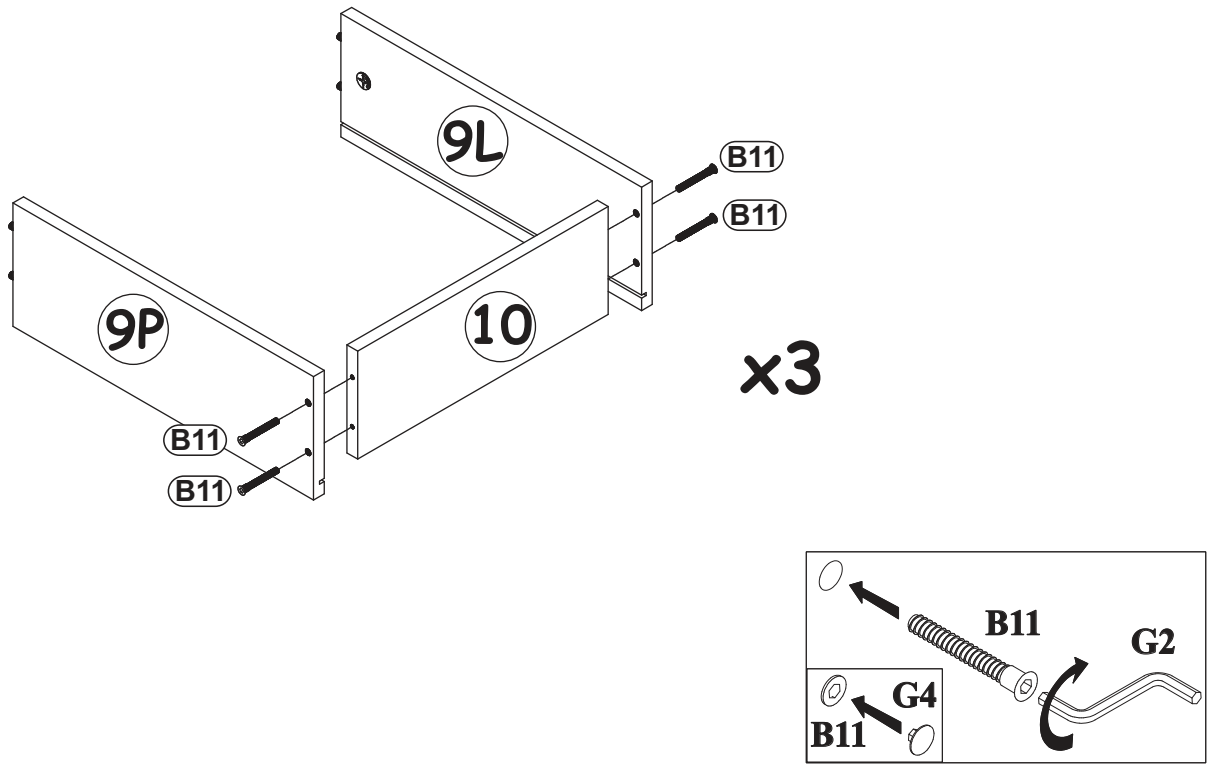

G5	
x6	

10

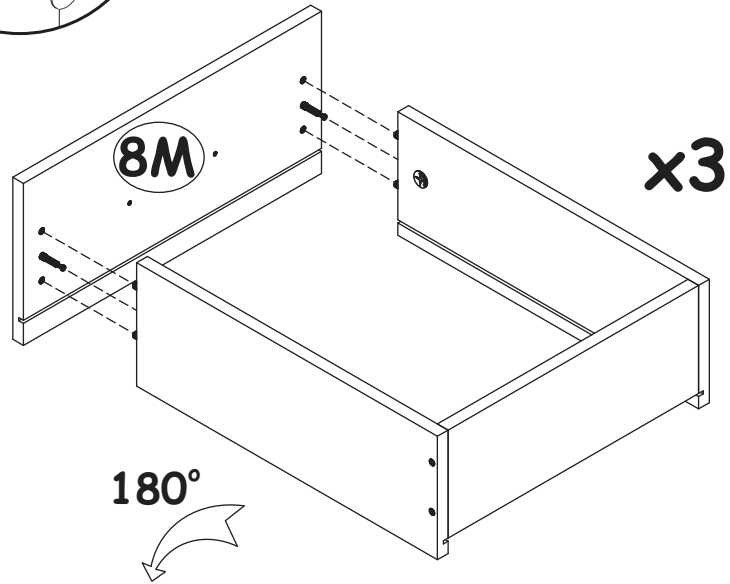
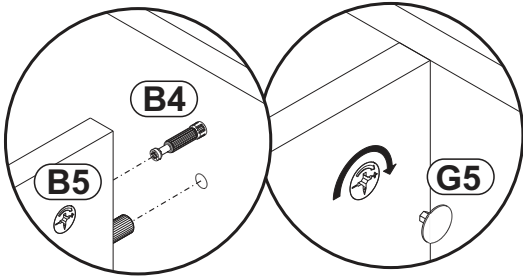

11

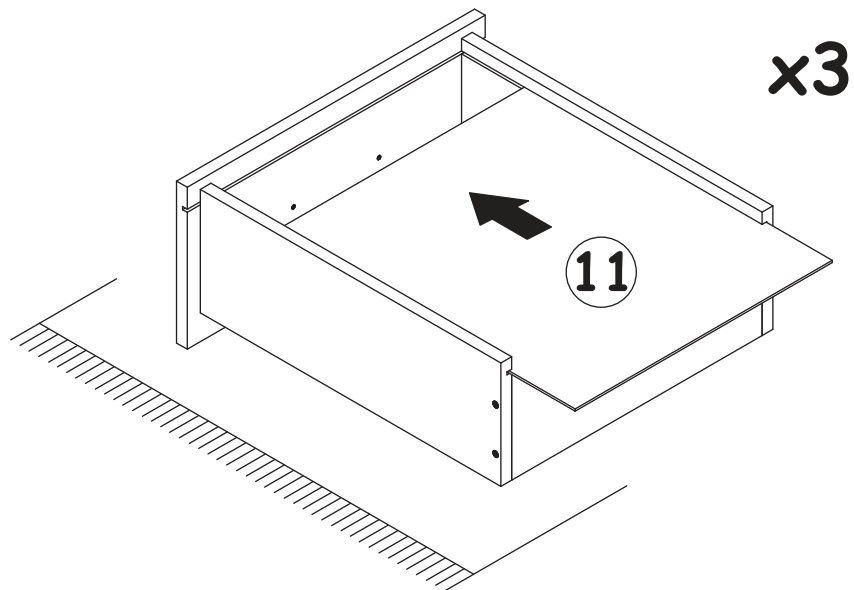

B3

x12



12

X=Y 90°

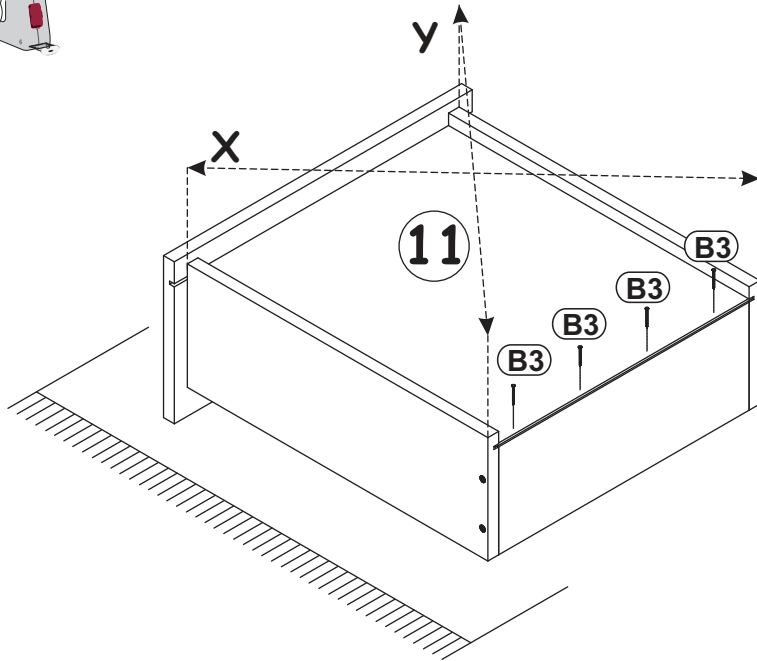

x3

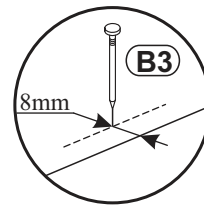

13

H5

x3

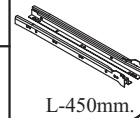

D10

x18

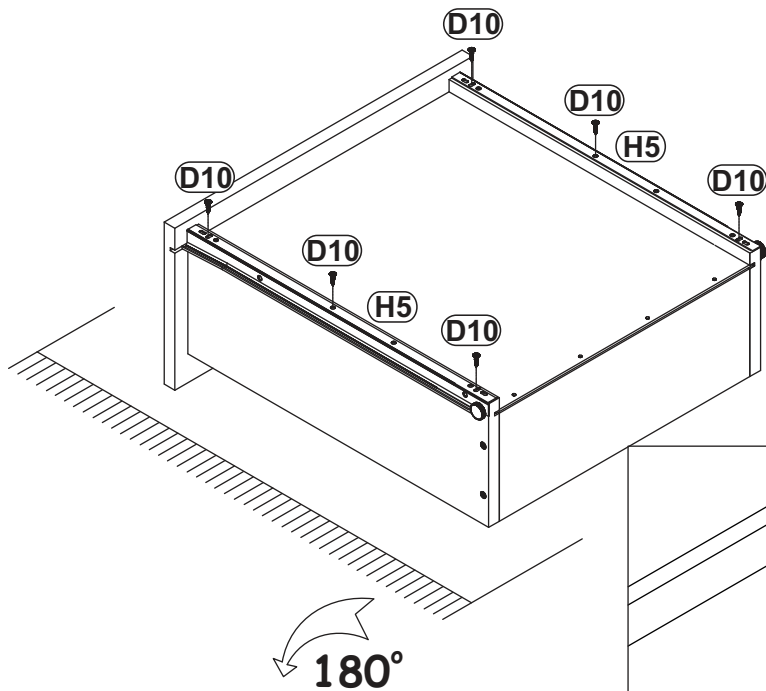

x3

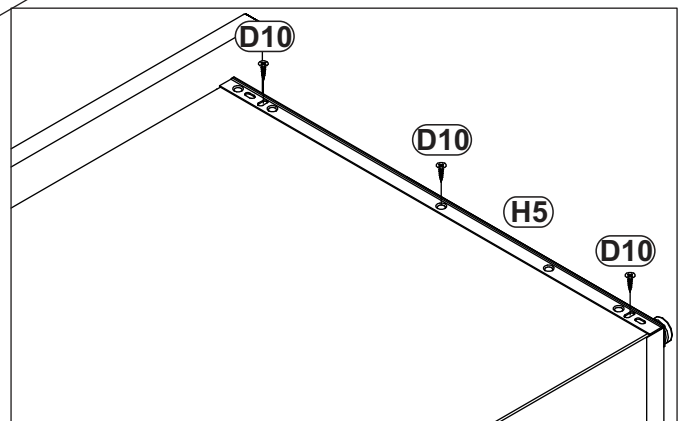

14

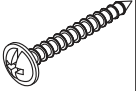
KL		UP6	
x3	L-128mm.	x6	UPØ4x30

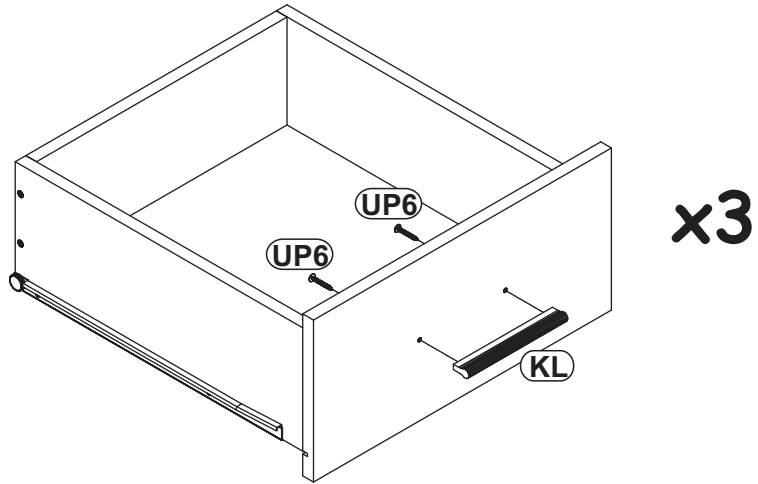

15

G5	
x4	

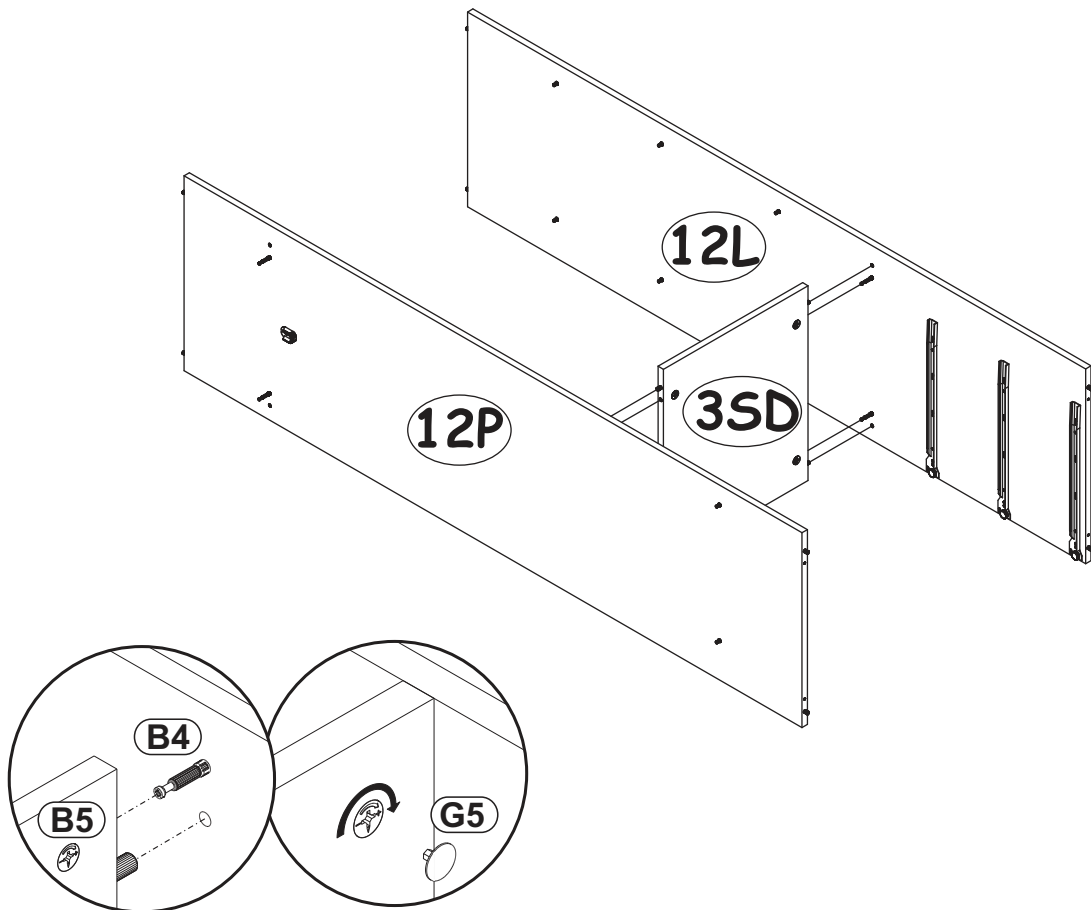

G5

x8



16

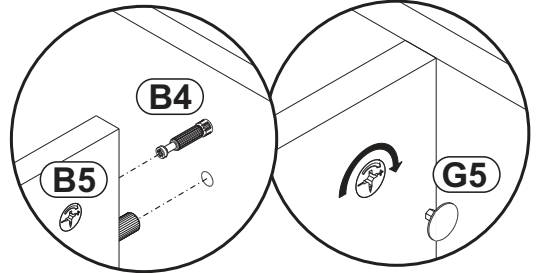
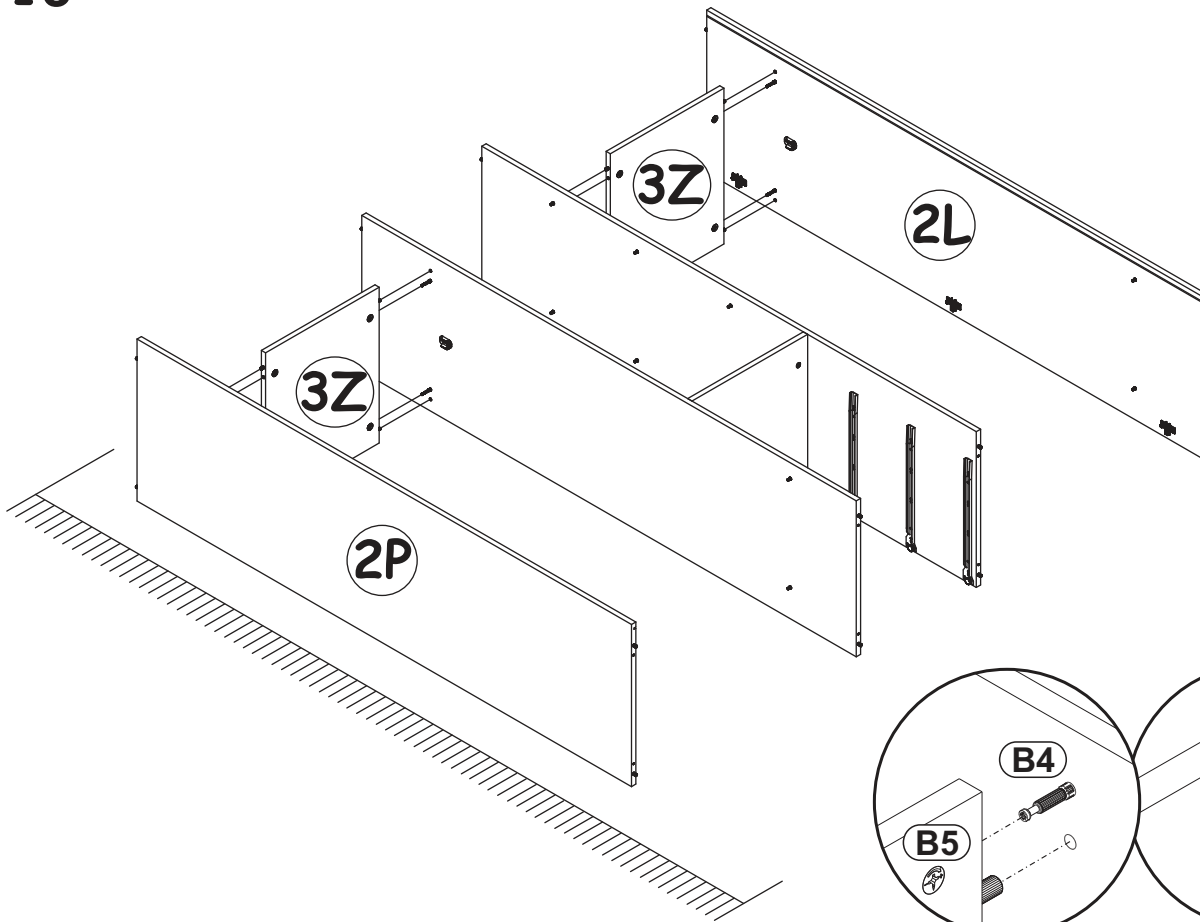

17

B11

x8

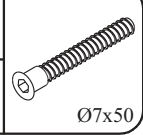

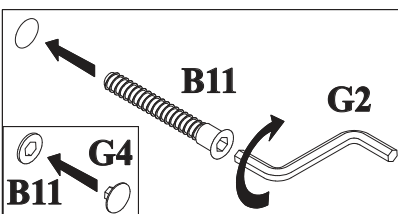
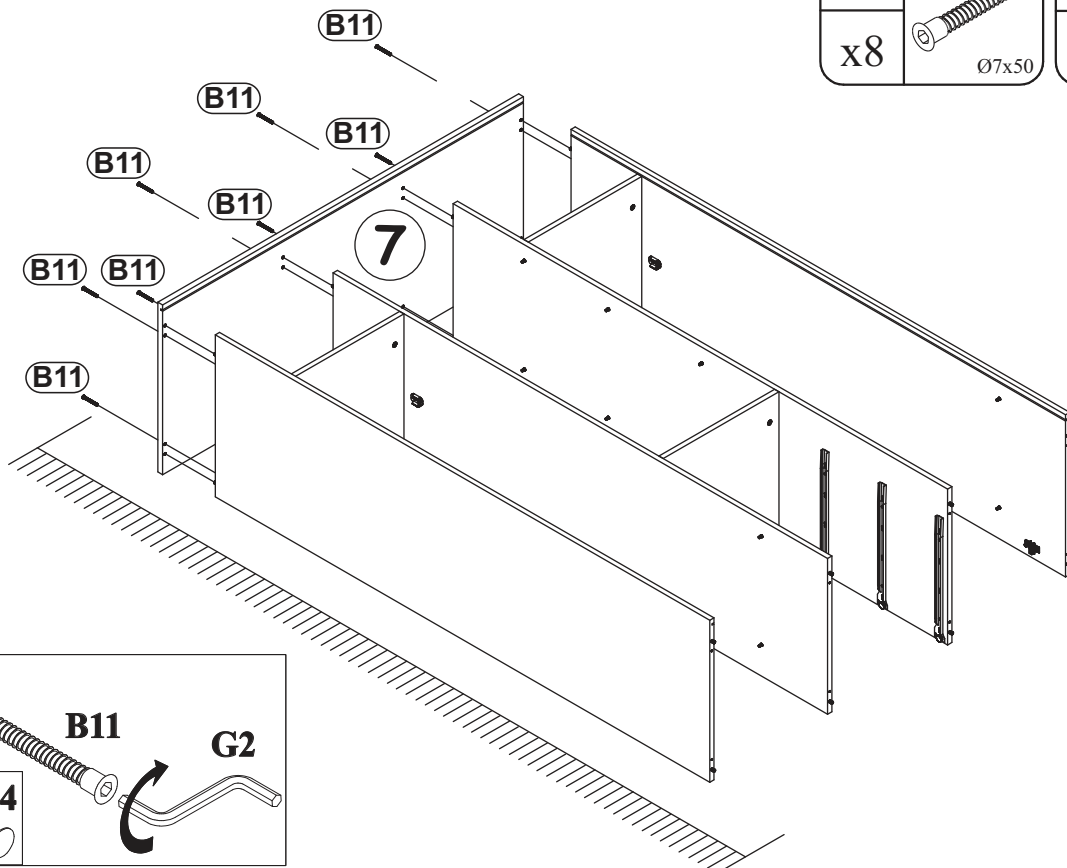

G4

x8



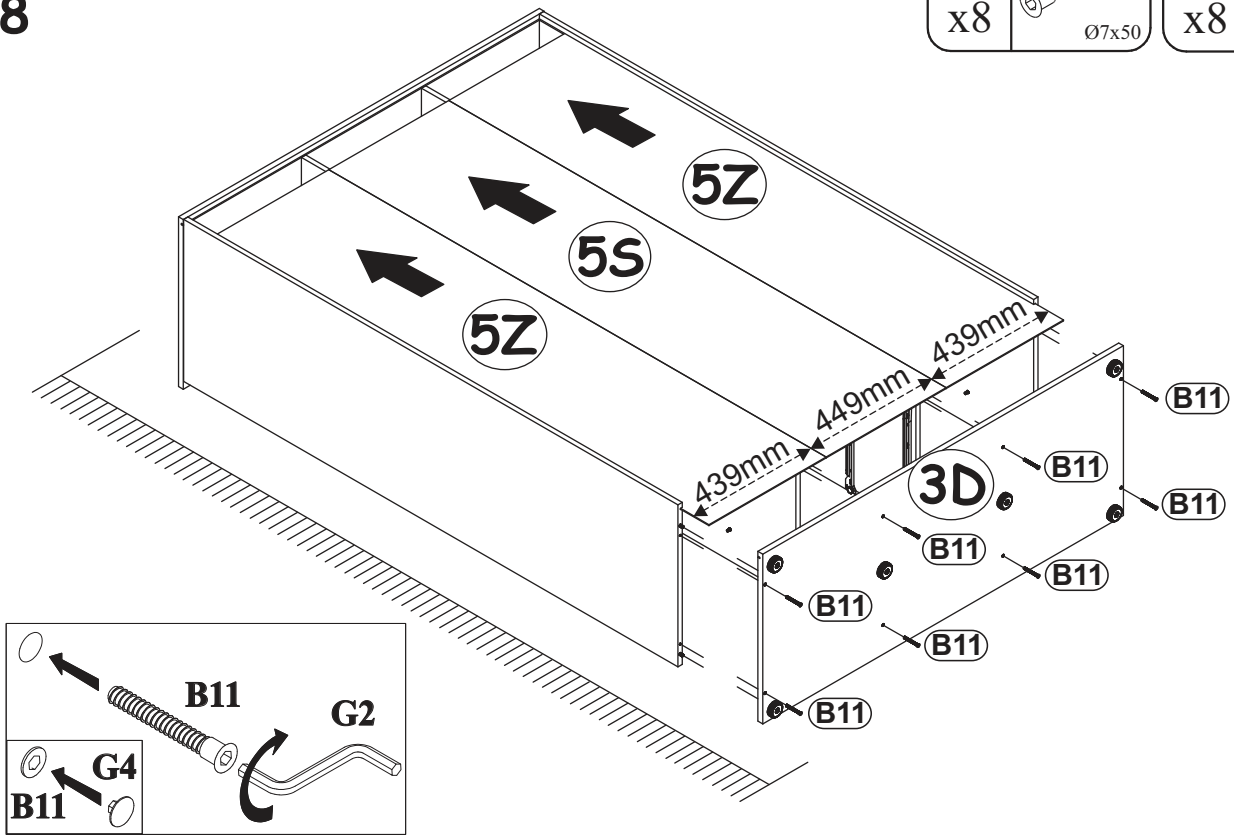

18

B11		G4	
x8	Ø7x50	x8	

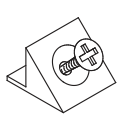
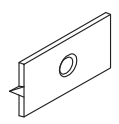

19

S1		G16		D9	
x16		x24		x24	USØ3x20

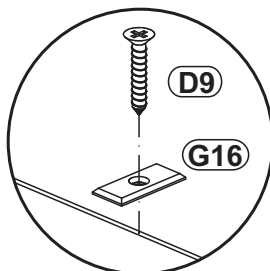
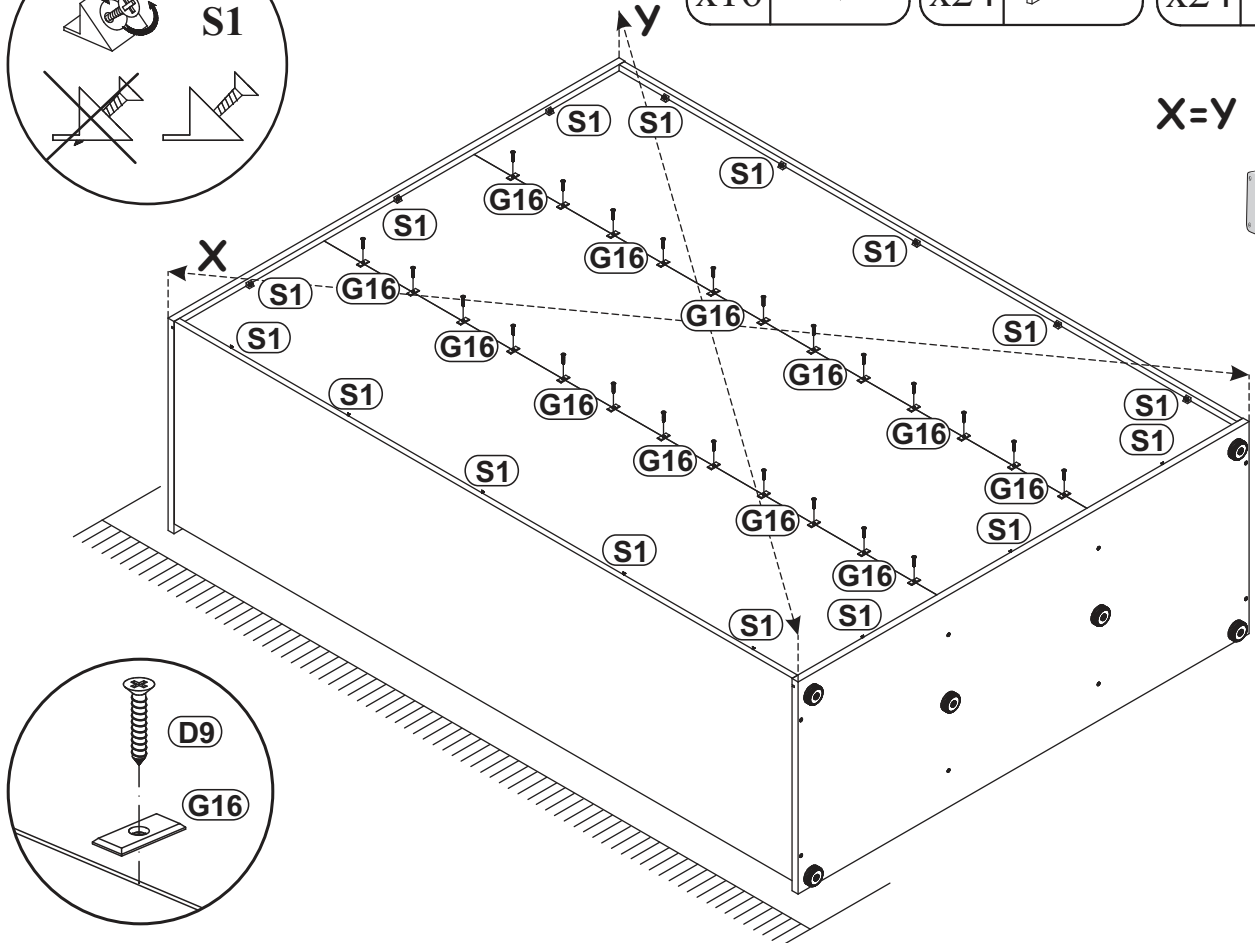
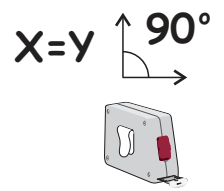
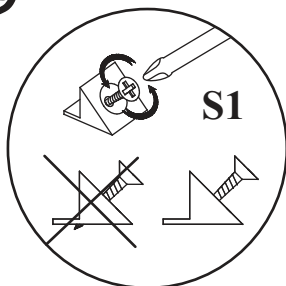

20

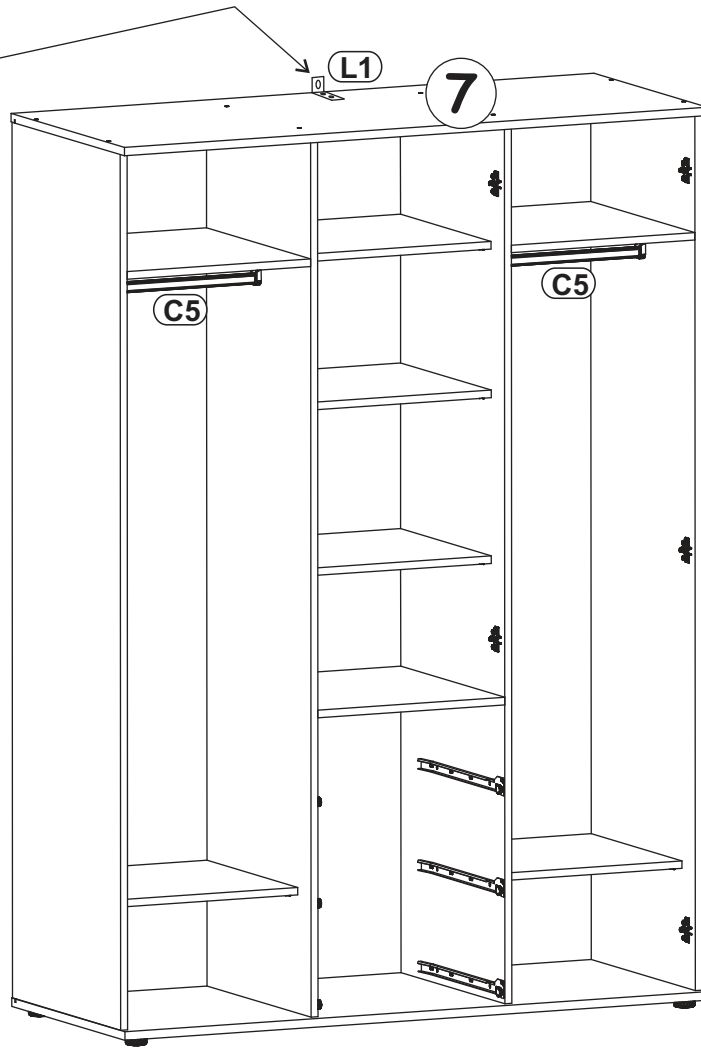
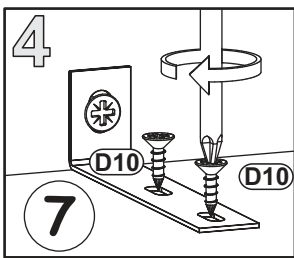
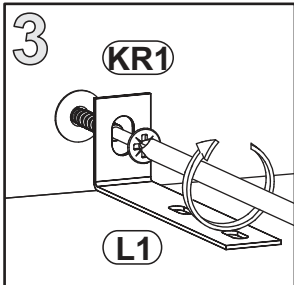
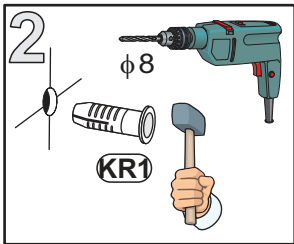
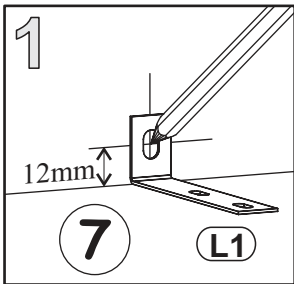
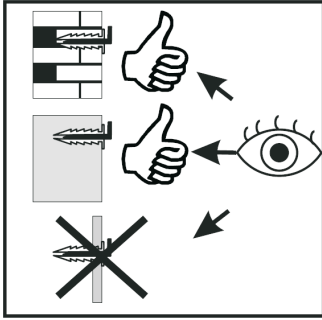
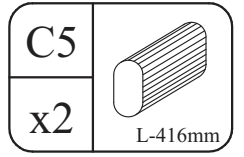
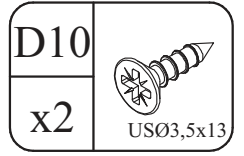
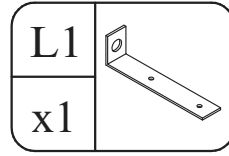
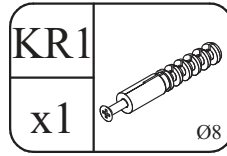

21

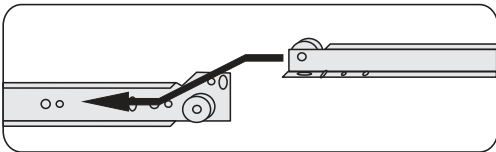
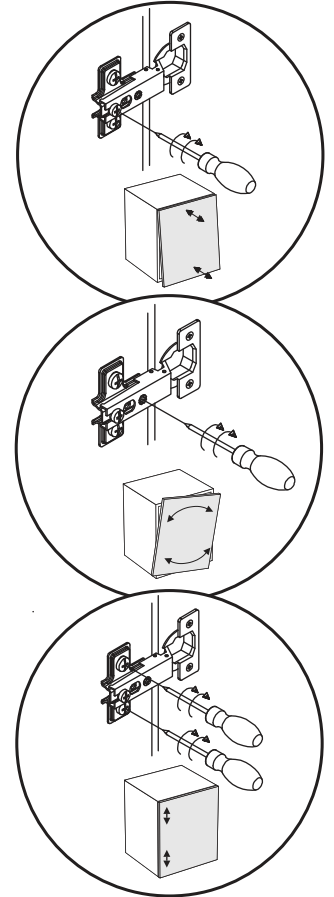
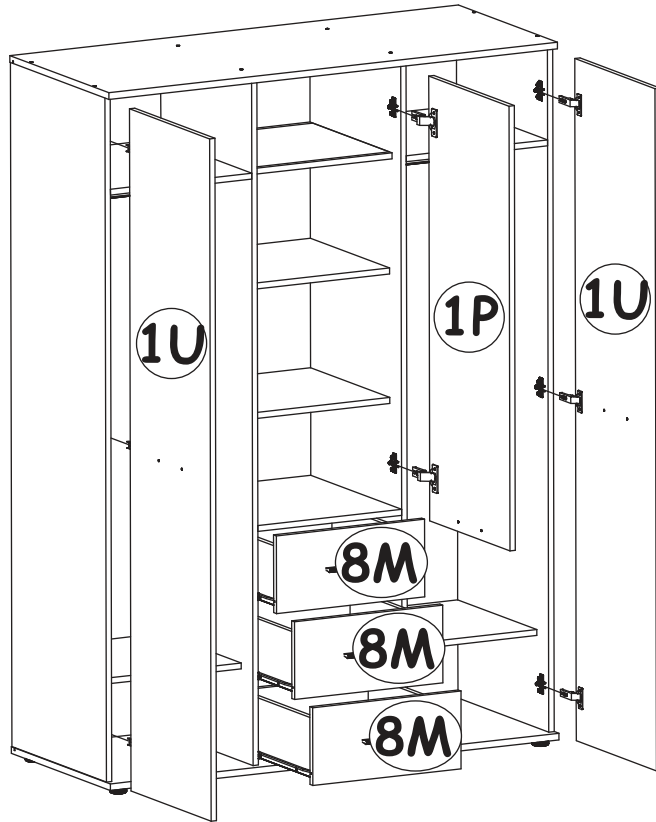

22

