

# BERLIN 20 \_BL WSW

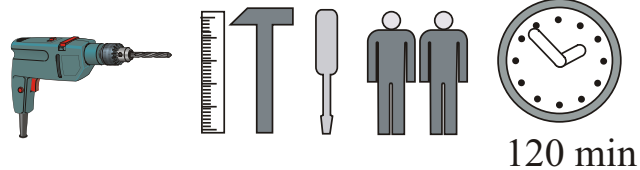

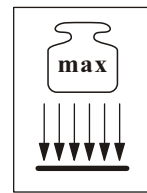

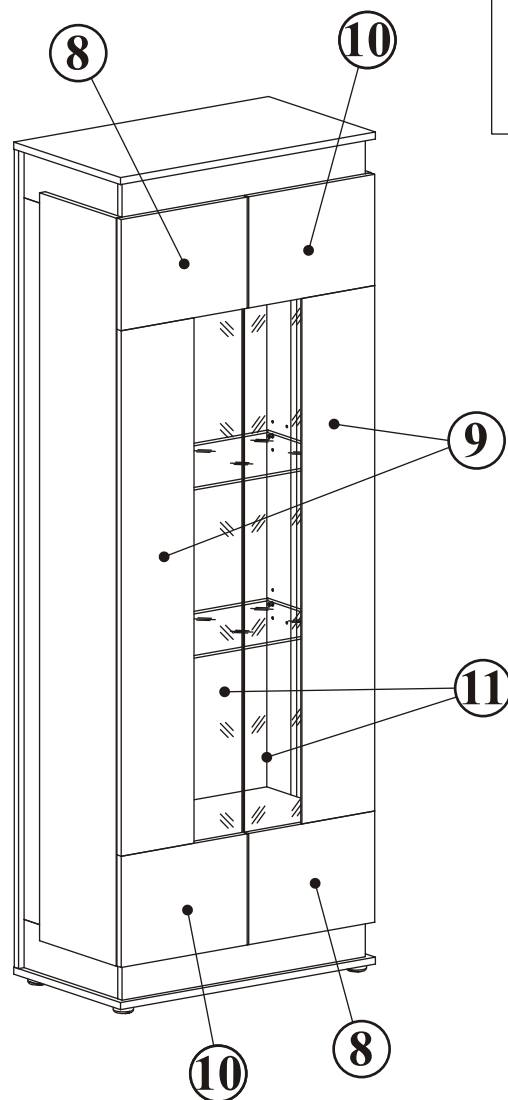

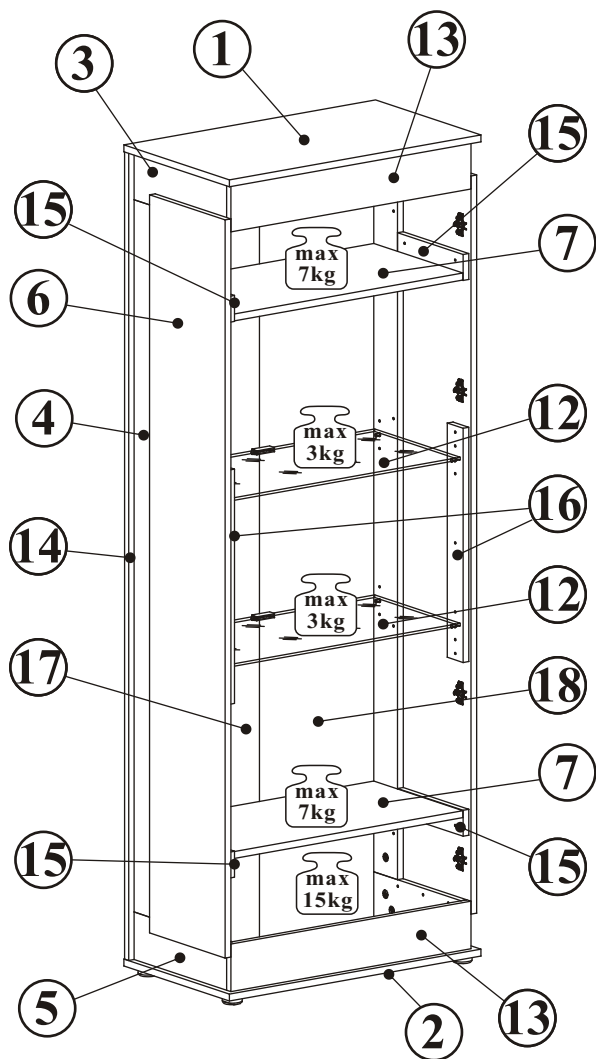



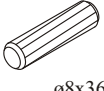
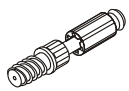

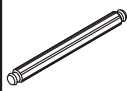
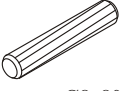
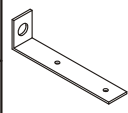

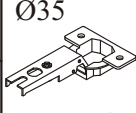
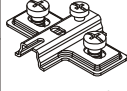
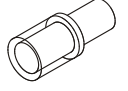
120 min

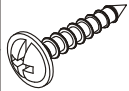
NO	Dim.			Col-No	Qty
1	700	400	16	1	1
2	700	400	16	1	1
3	110	351	16	1	2
5	110	351	16	1	2
7	636	338	16	1	2
8	346	254	16	1	2
10	346	254	16	1	2
12	635	324	6	1	2
13	668	110	16	1	2
16	542	60	16	1	2

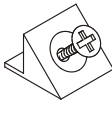
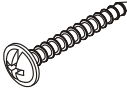
NO	Dim.			Col-No	Qty
4	1648	110	16	2	2
6	1708	287	16	2	2
9	1200	200	16	2	2
11	1250	183	4	2	2
14	1868	60	16	2	2
17	1880	324	3	2	1
18	1880	324	3	2	1
15	249	60	16	2	4

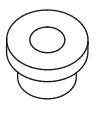
# BERLIN 20\_BL WSW

A1 x30  ø8x36	B4 x28 	B5 x52  ø15x12	G5 x52 	B6 x12  Ø7x76	A6 x16  Ø8x80
L1 x1 	KR1 x1 	UP13 x24  UPØ3x16	E21 x8  Ø35 H=0	E2 x8  H=0	G20 x8 
D10 x18  USØ3,5x13	UP11 x4  UPØ4x20	I11 x4  Ø45, h=15	S1 x8 	UP6 x34  UPØ4x30	G2 x1 
P2 x14 	LED x1  x2	UP12 x8  UPØ3,5x30			

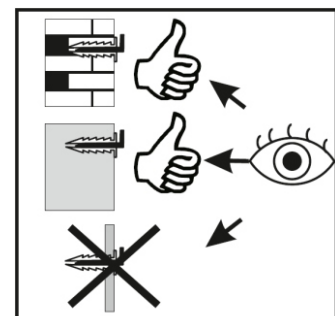
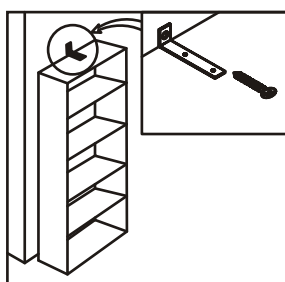
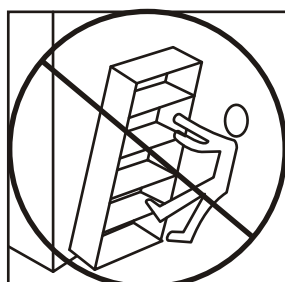
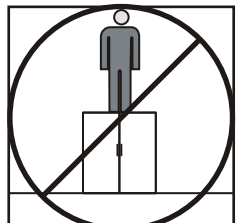
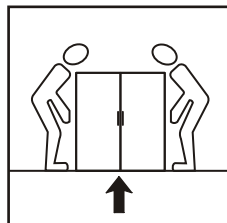
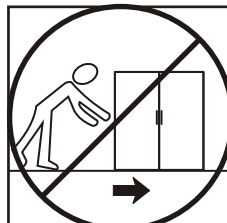
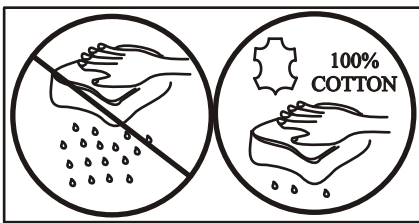
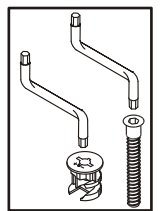
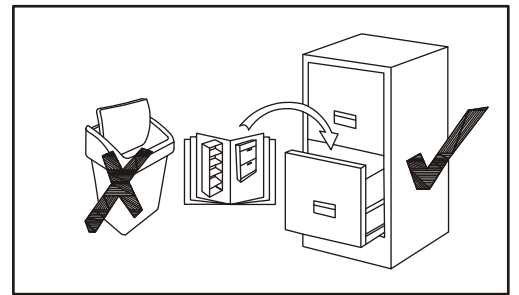
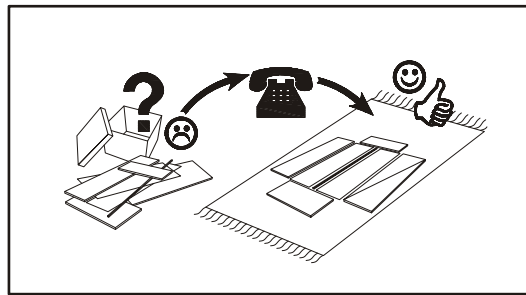
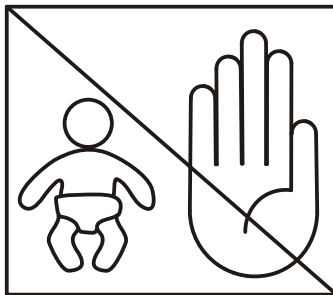
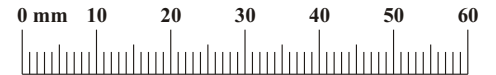

BERLIN 20\_BL WSW

1

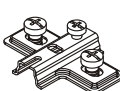
E2	
x8	H=0

B5	
x32	ø15x12

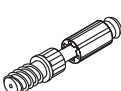
B4	
x4	

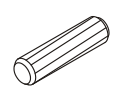
A1	
x30	ø8x36

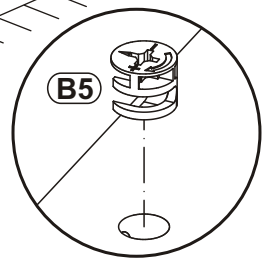
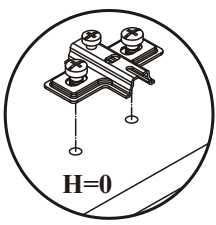
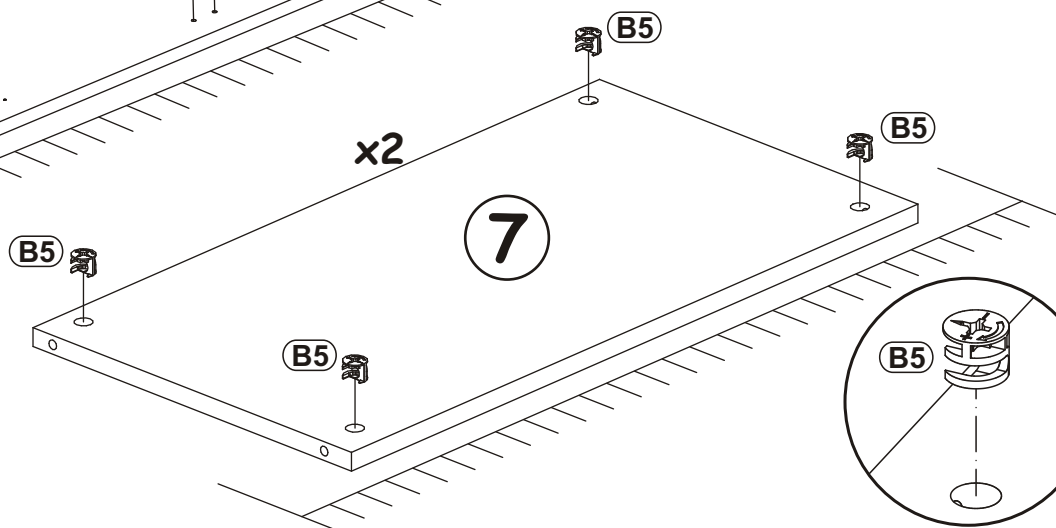
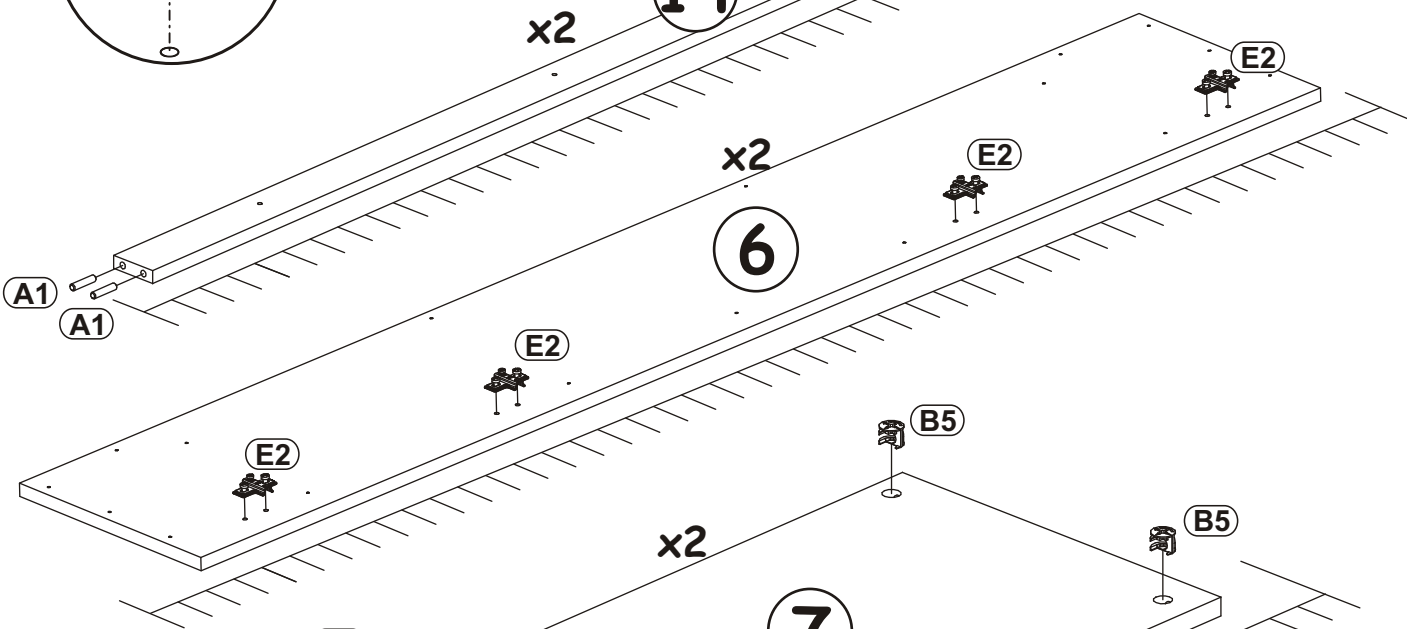
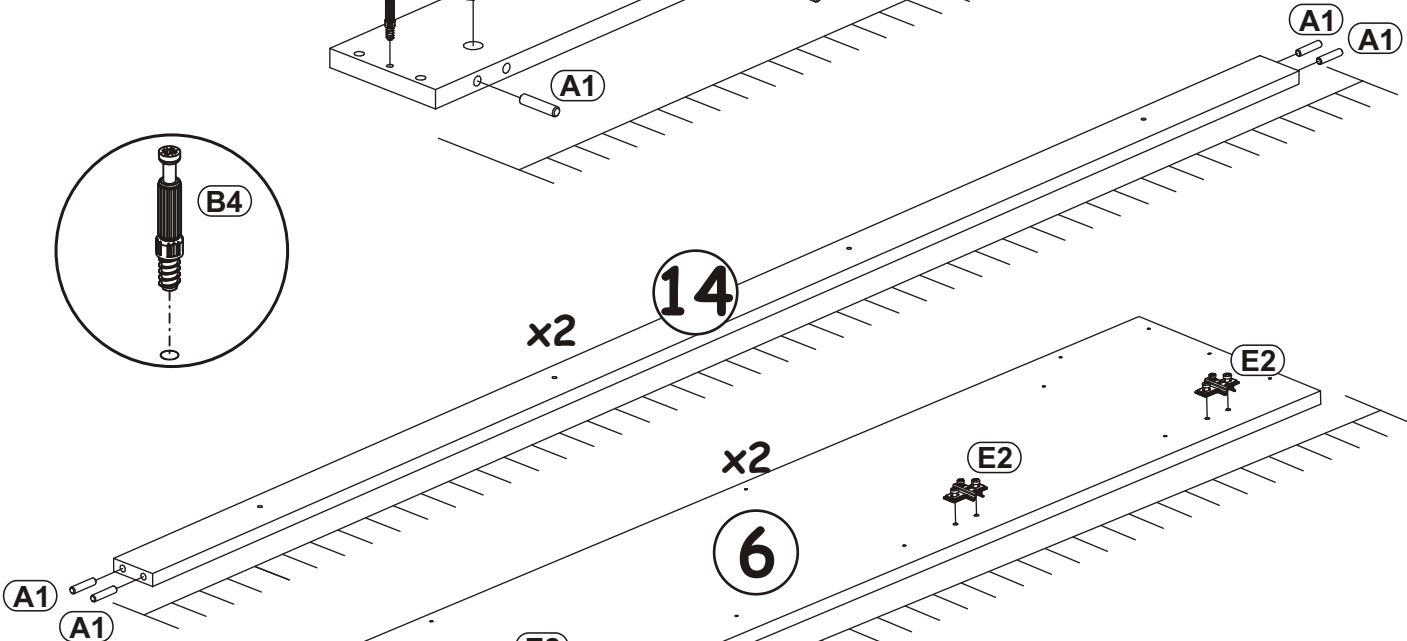
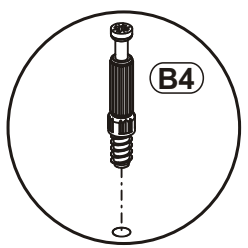
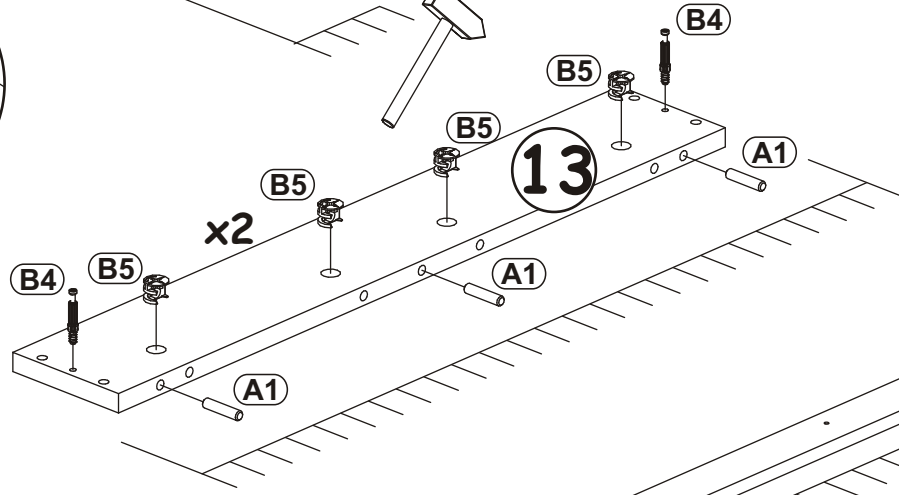
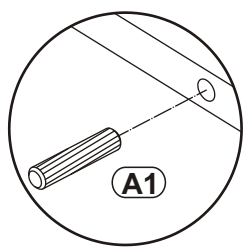
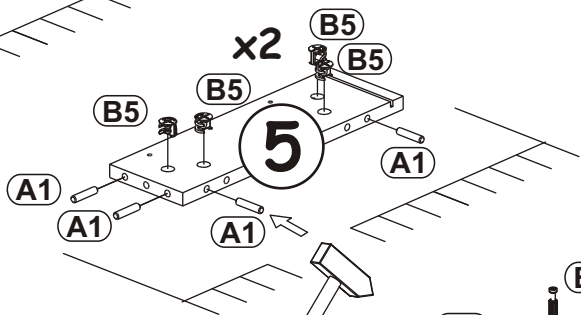
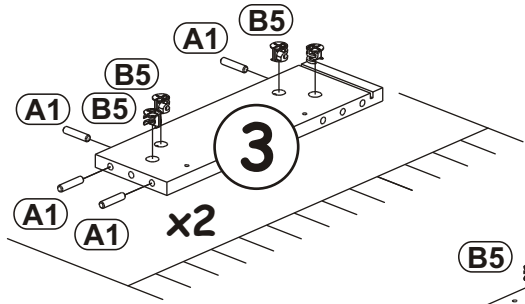

2

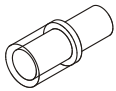
G20	
x8	

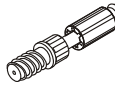
B4	
x8	

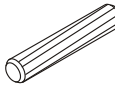
A6	
x16	Ø8x80

B5	
x20	ø15x12

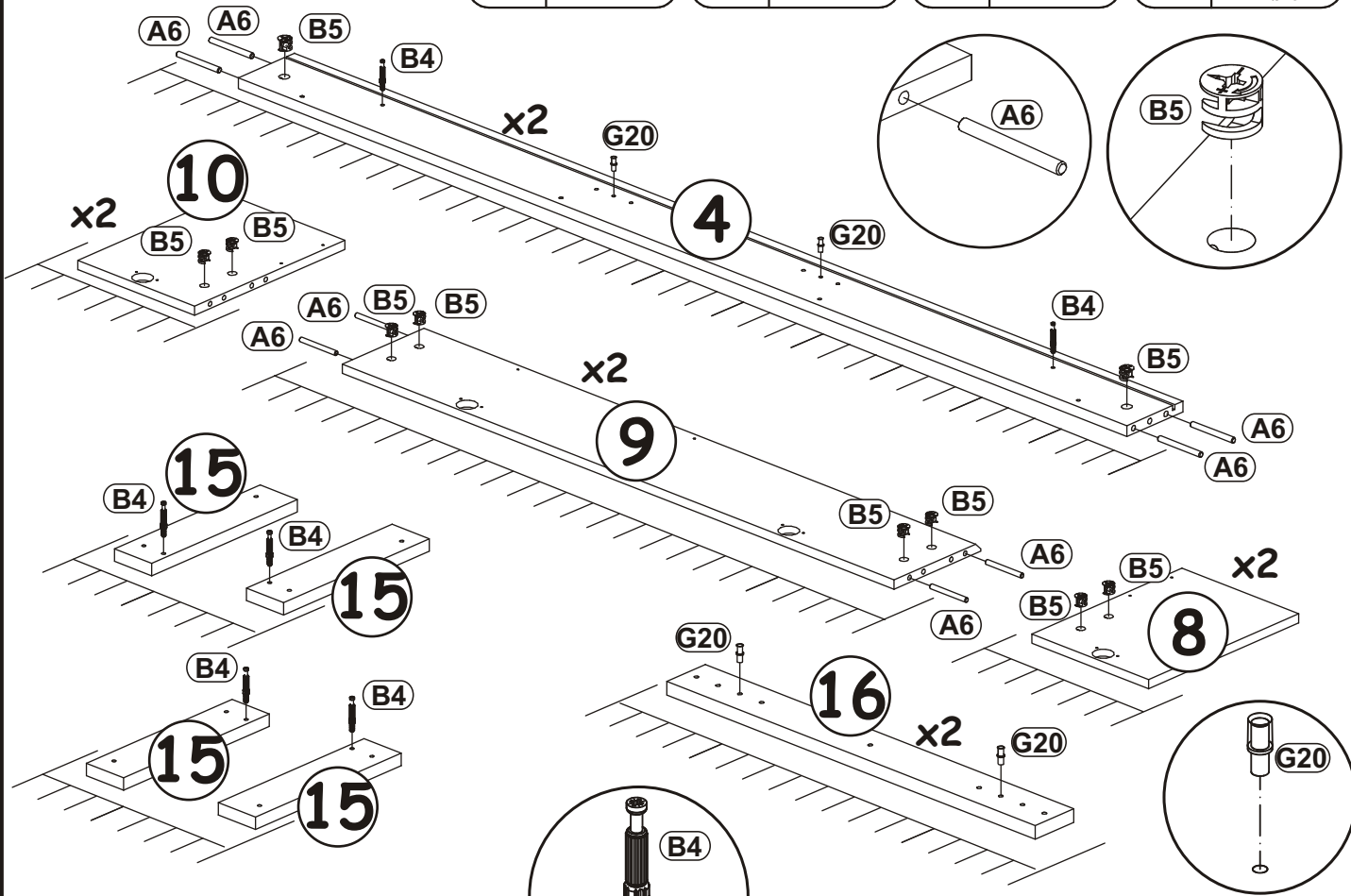

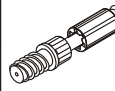

3

B4	
x16	

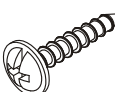
I11	
x4	Ø45, h=15

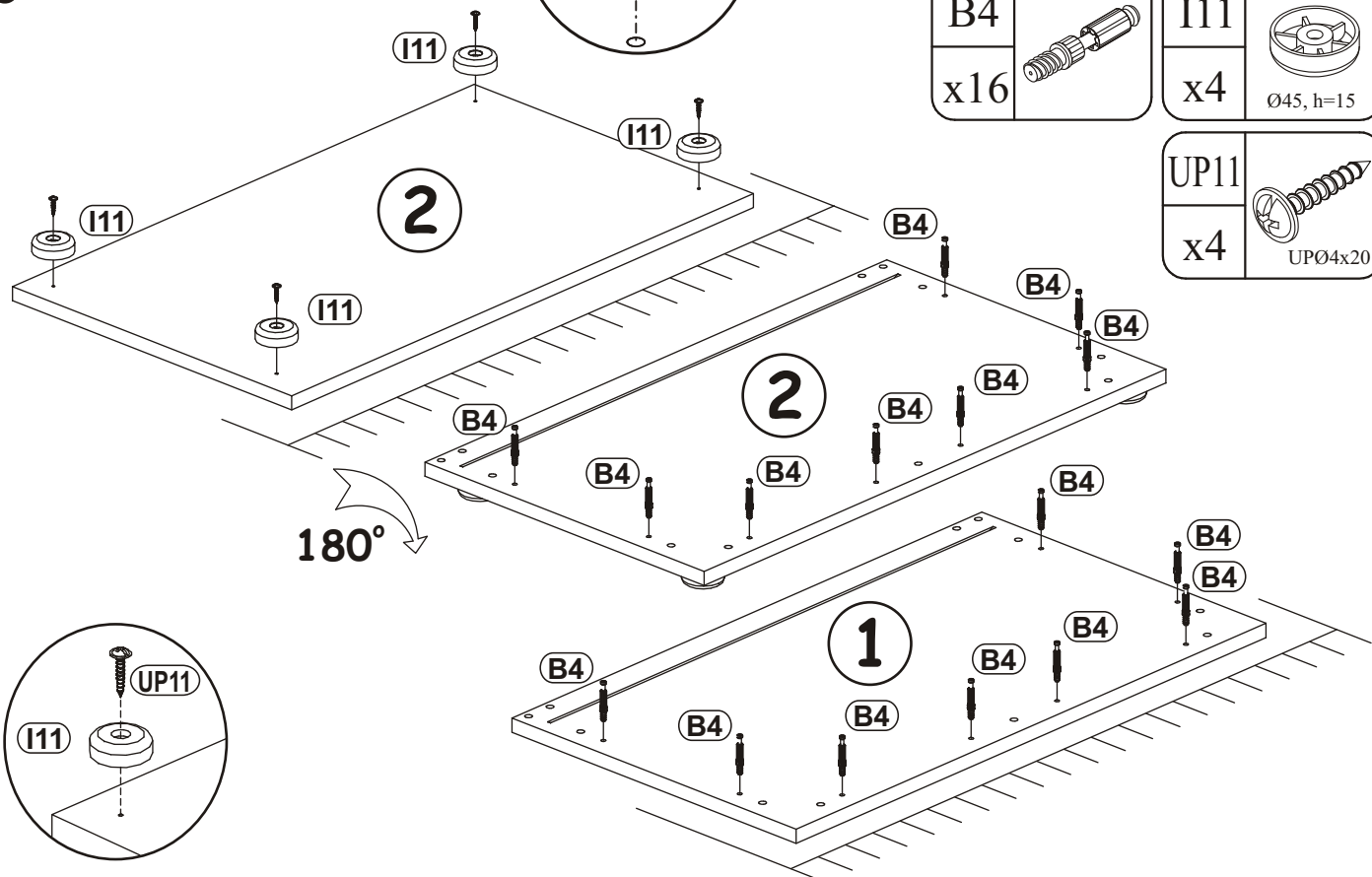
UP11	
x4	UPØ4x20



B6	
x12	Ø7x76

G5	
x24	

4

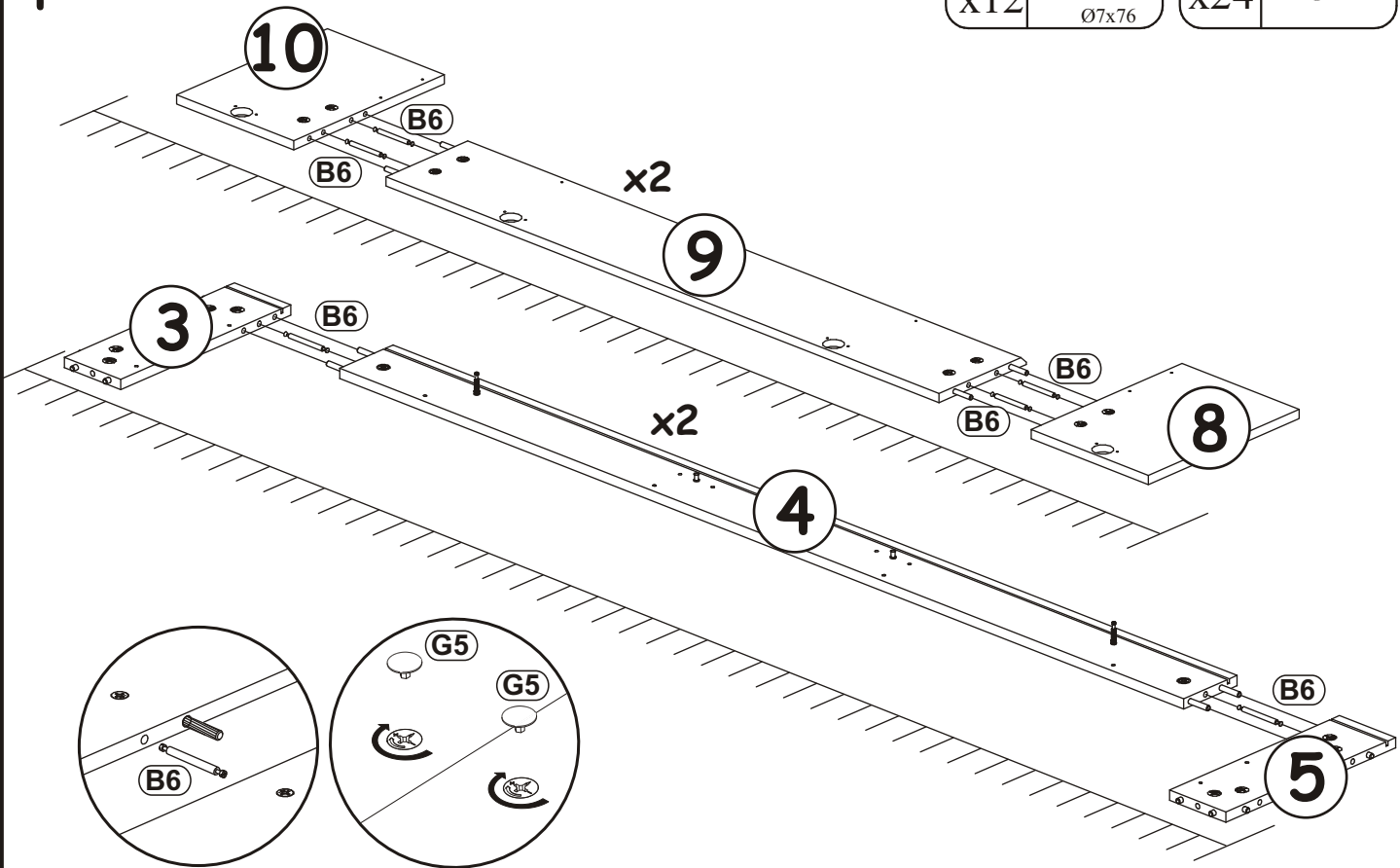

5

UP13	
x14	UPØ3x16

D10	
x16	USØ3,5x13

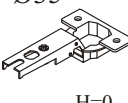
E21	
x8	Ø35 H=0

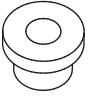
P2	
x14	

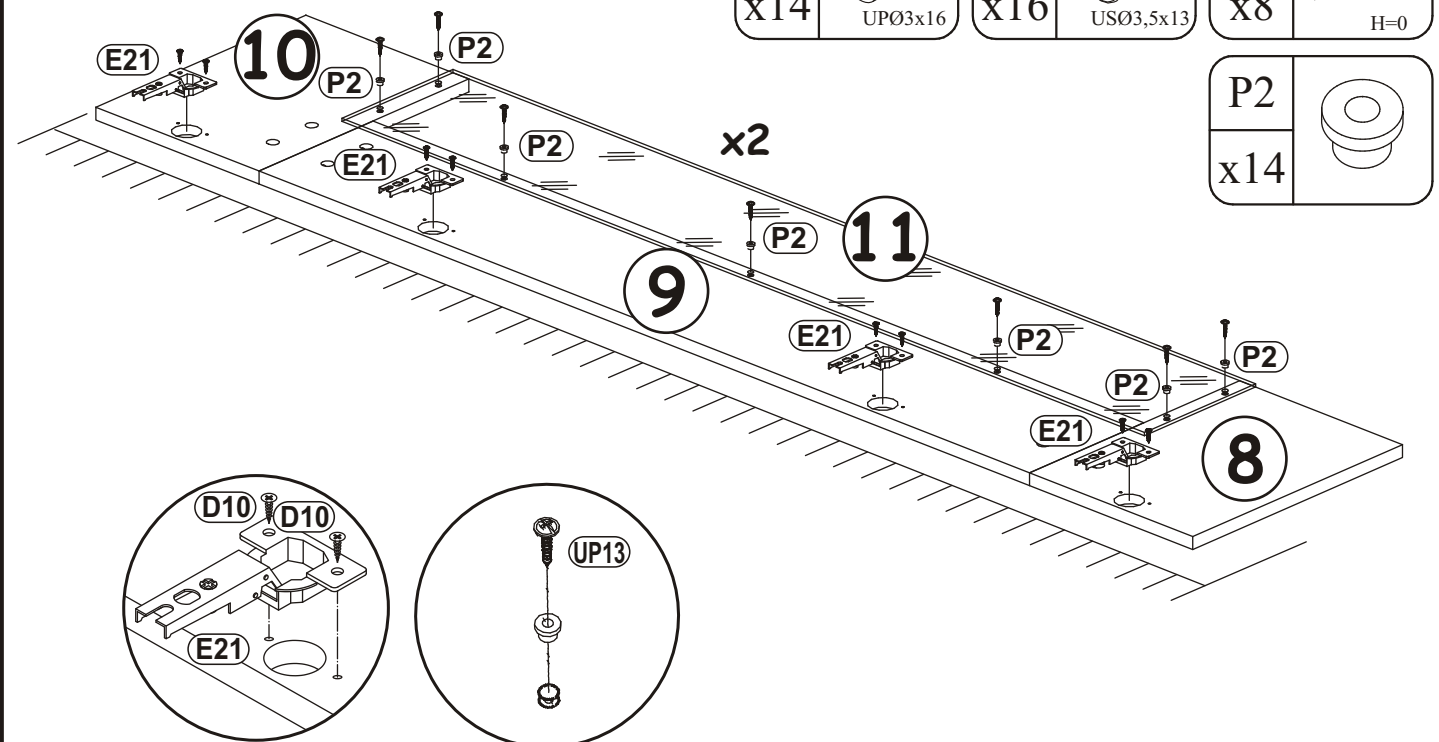

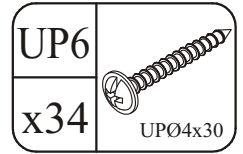

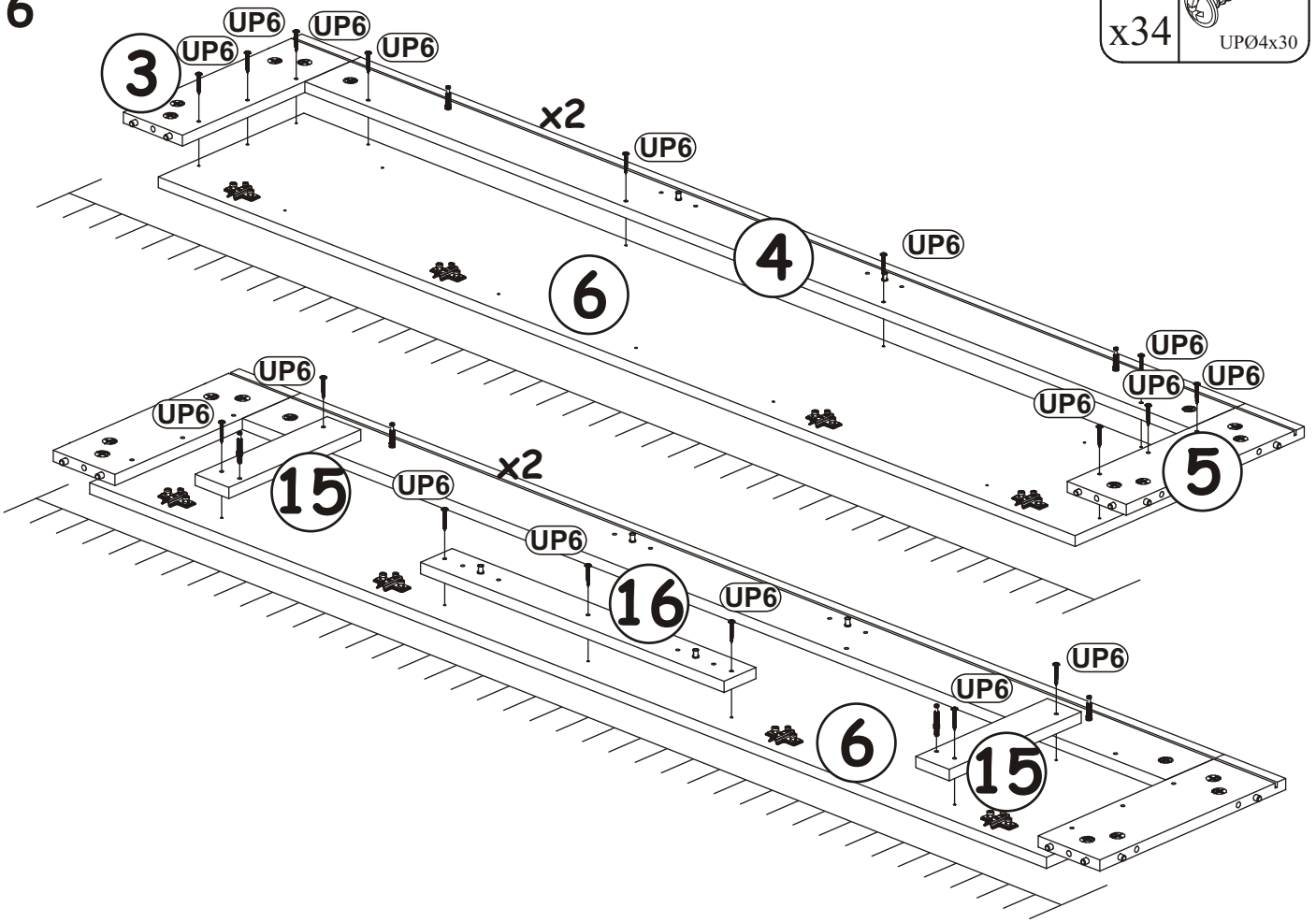

6

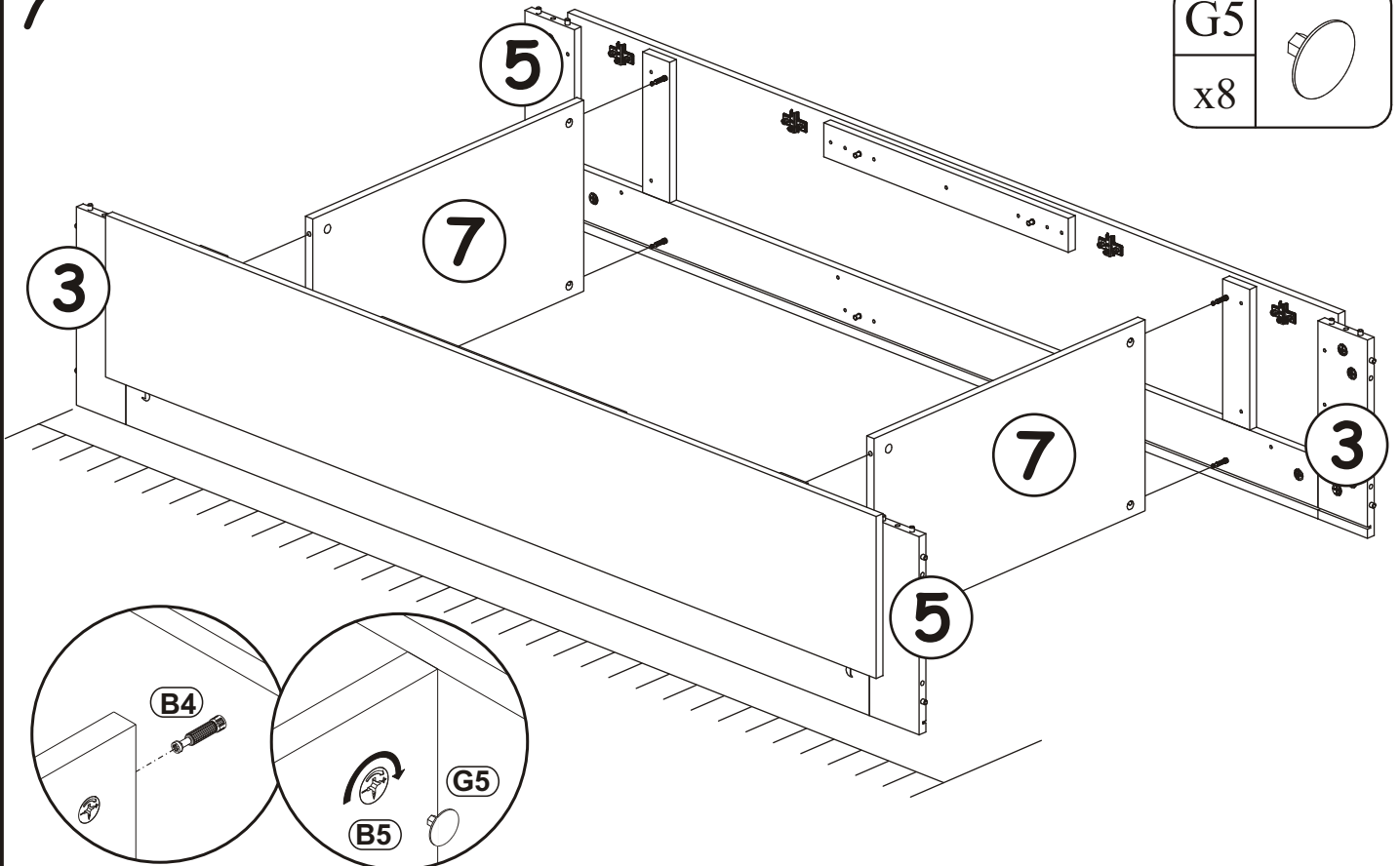
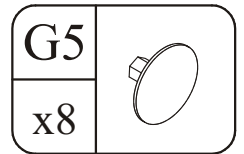

7



G5	
x4	

8

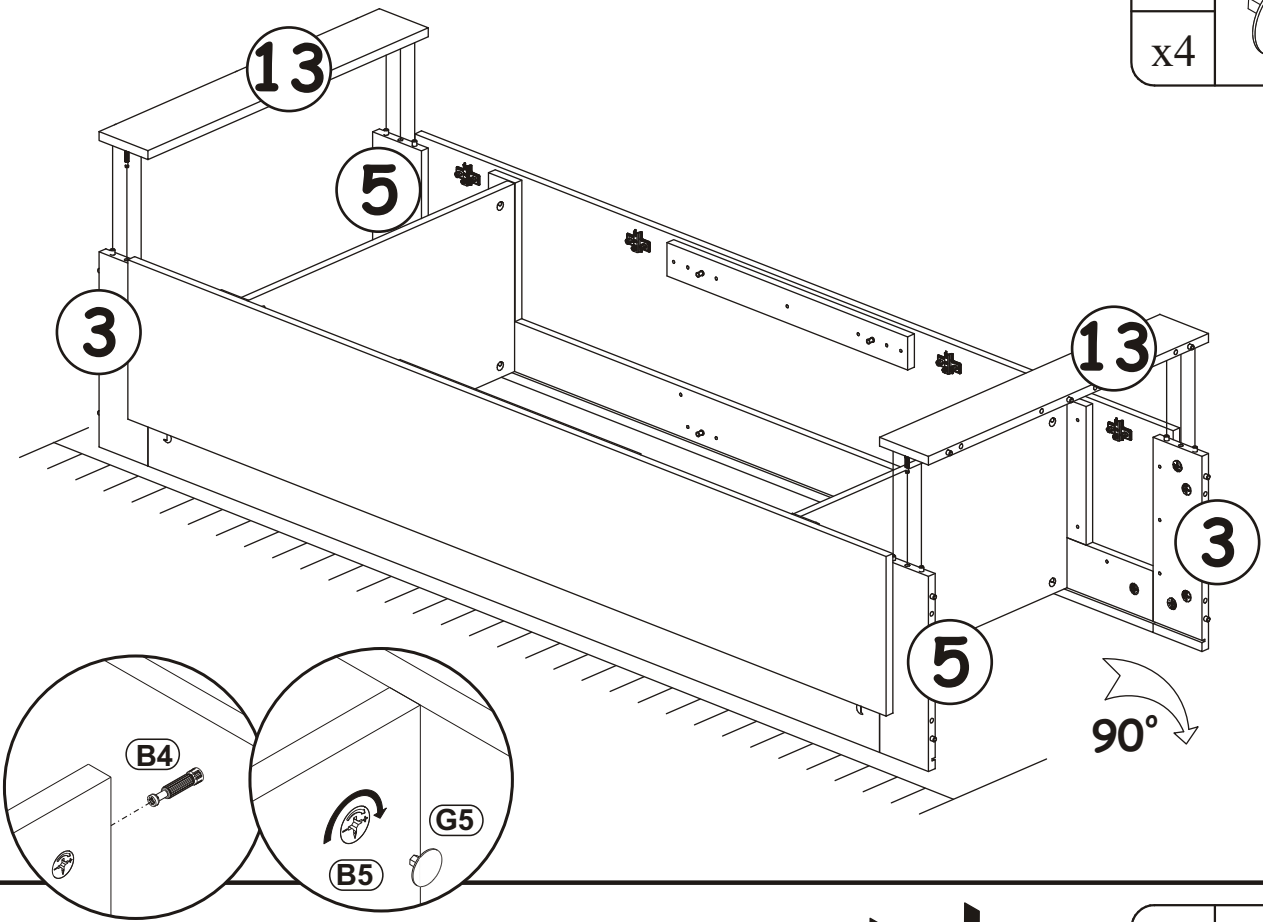

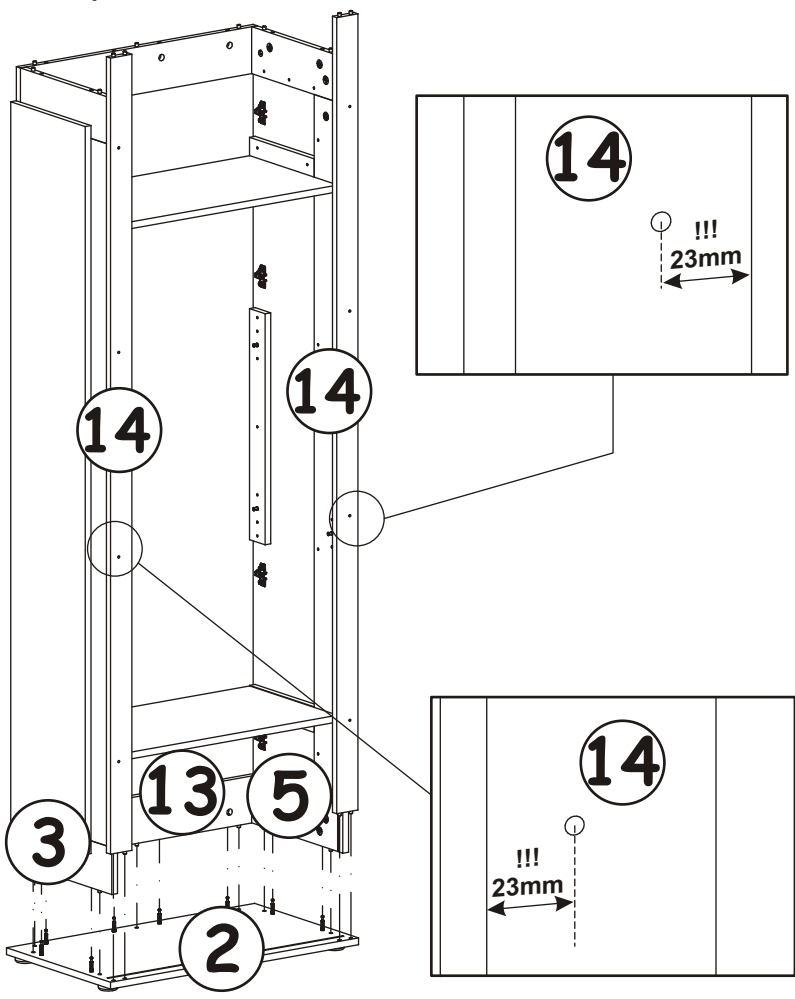

9

a)

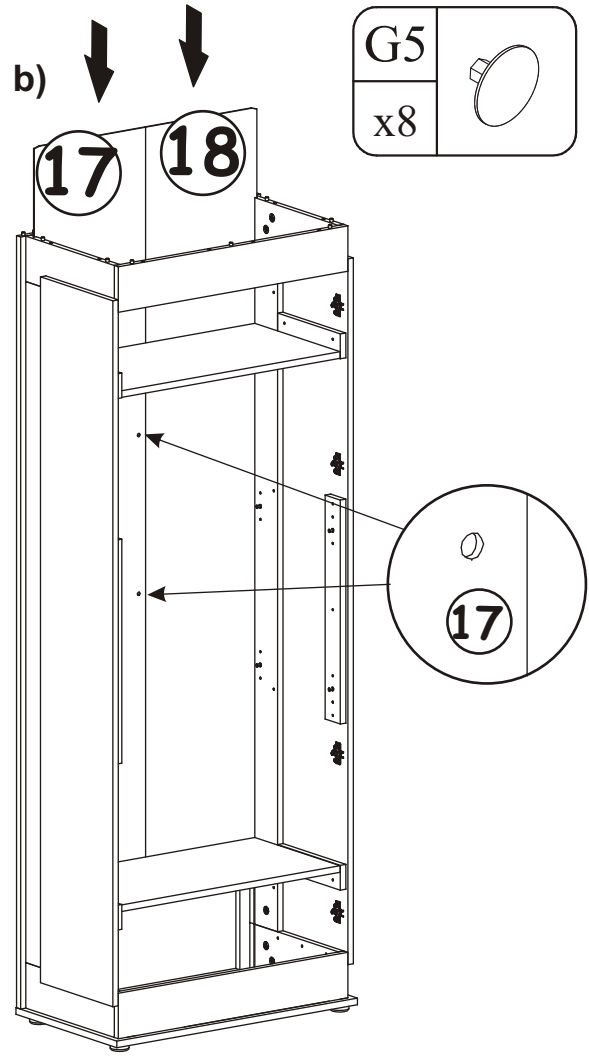

b)



G5	
x8	

10

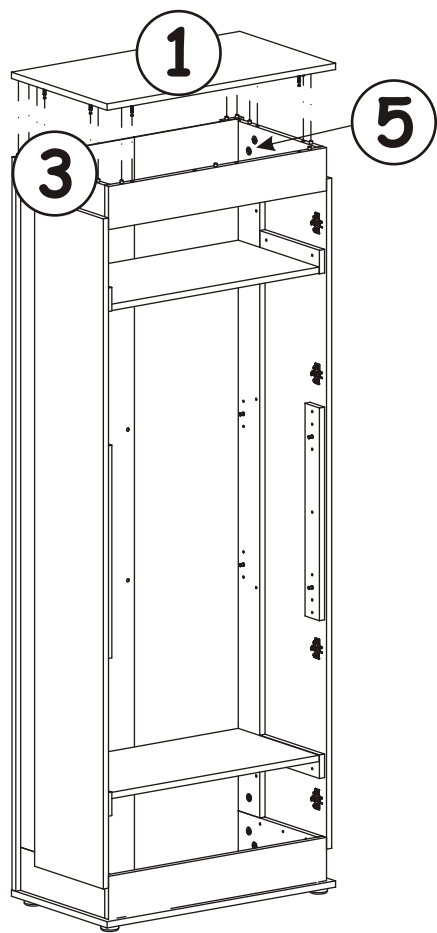

G5	
x8	

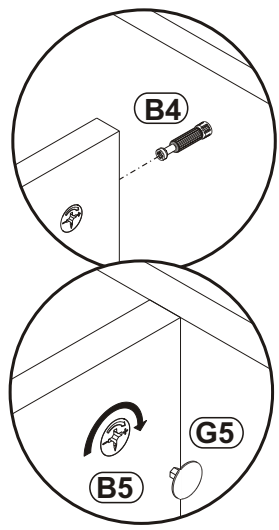

11

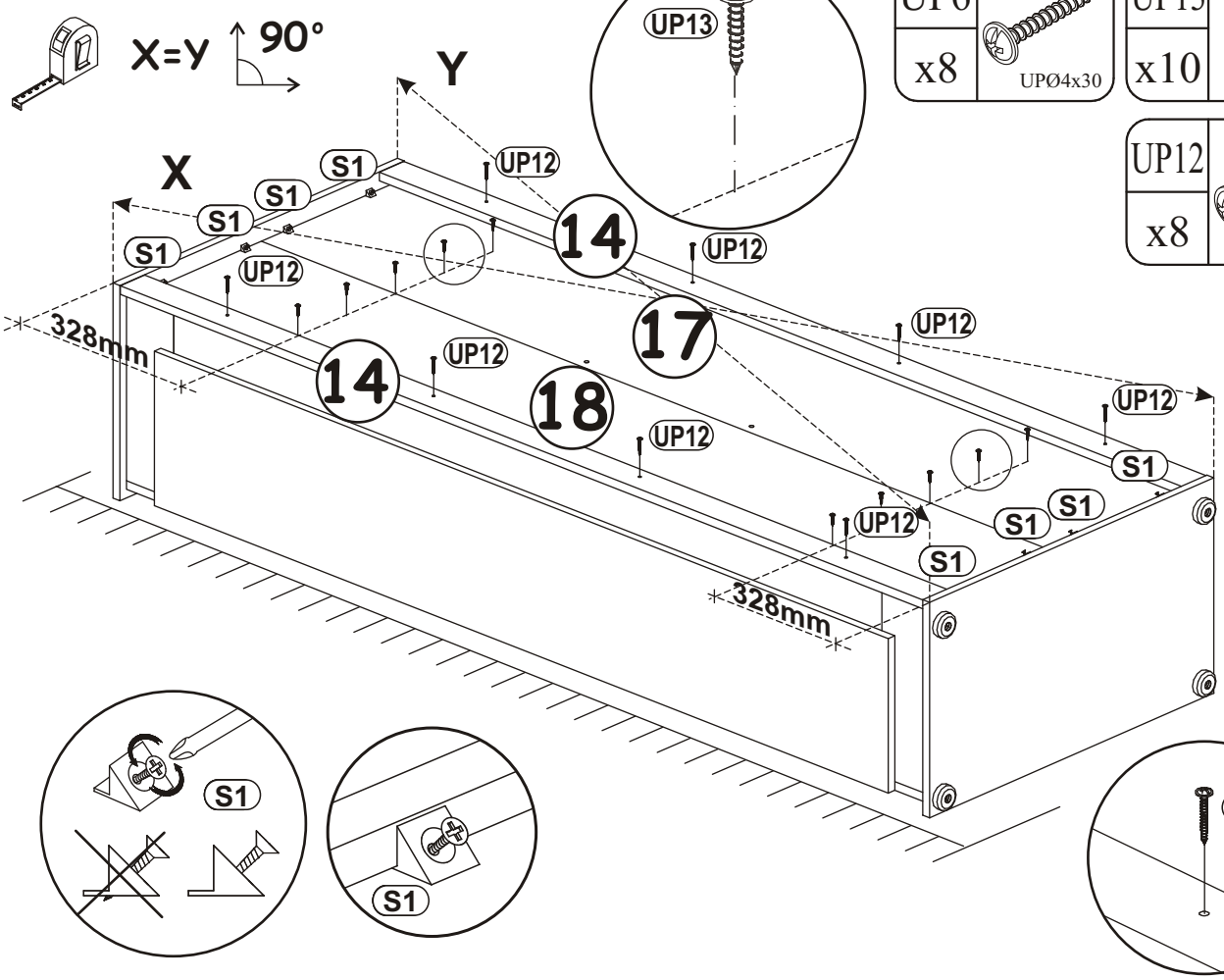

UP6	
x8	UPØ4x30

UP13	
x10	UPØ3x16

UP12	
x8	UPØ3,5x30

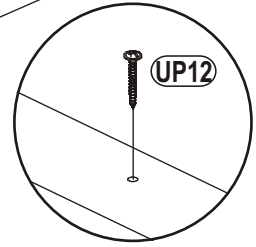
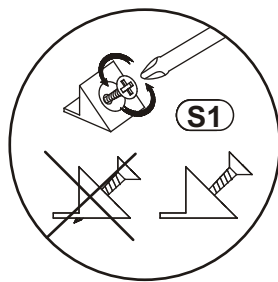



12

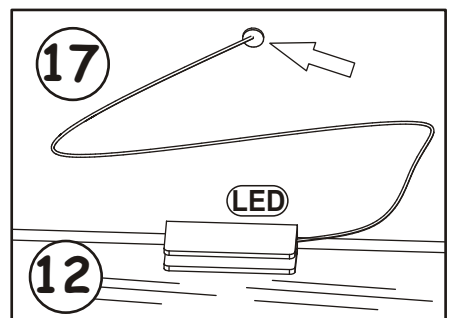
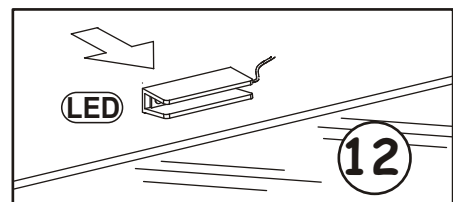
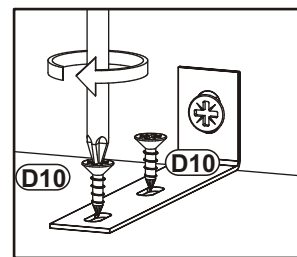
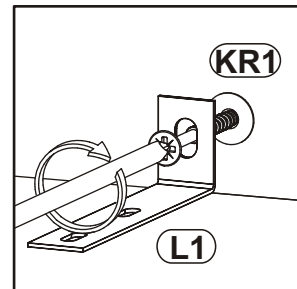
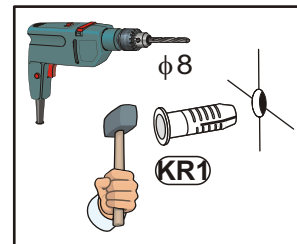
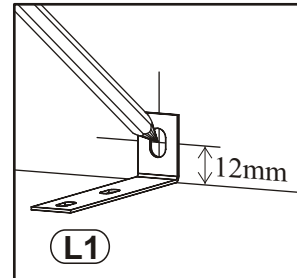
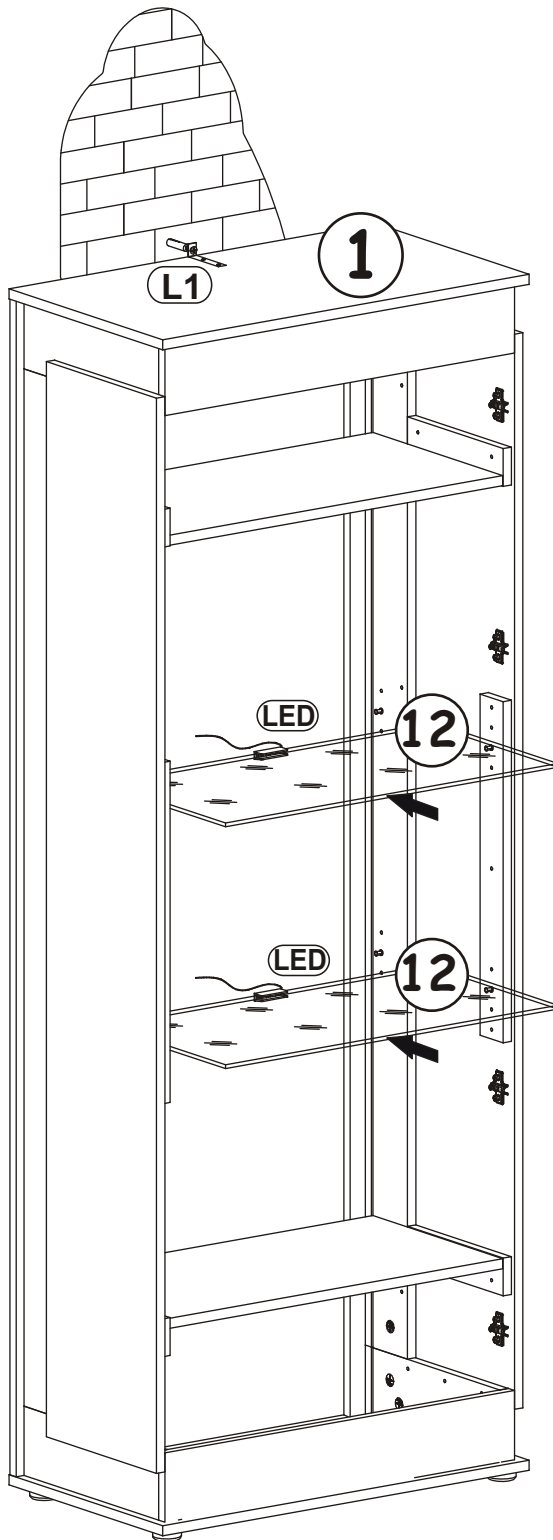
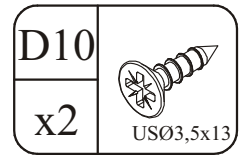
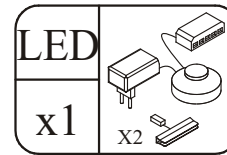
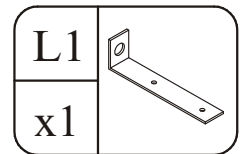
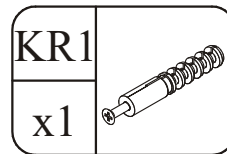
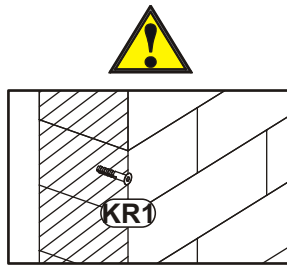
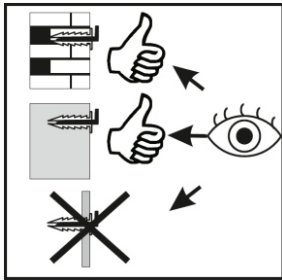

13

