

VIVALA RTV

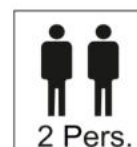

CZ: Povrch nábytku čistíte pouze přípravky určenými k ošetřování nábytku.

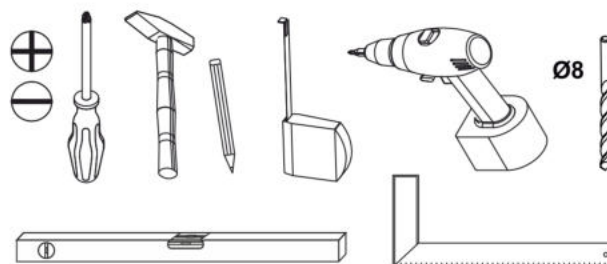

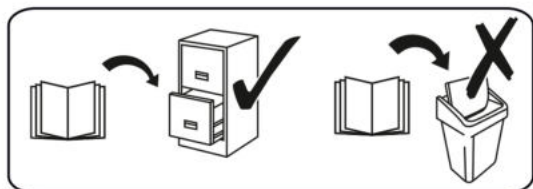
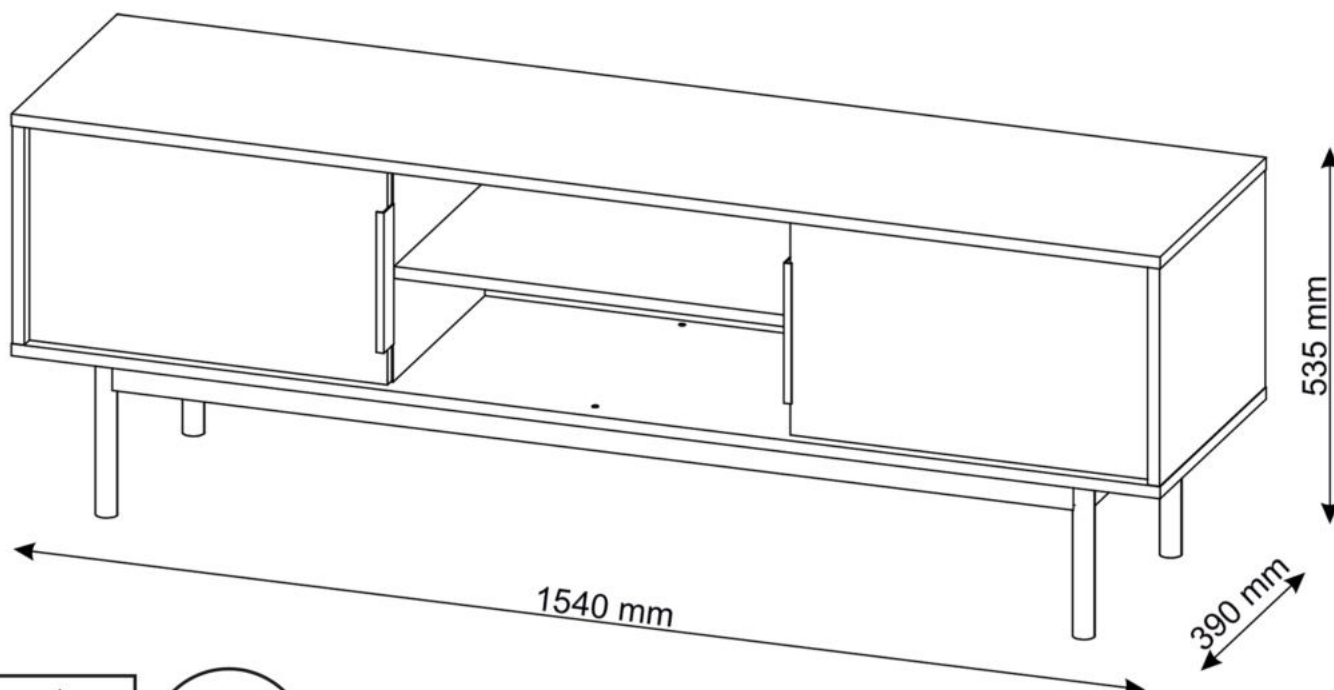







SK: Povrch nábytku čistíte iba prostriedkami určenými na ošetrovanie nábytku.









RO: Suprafața ei trebuie să fie curățată numai cu substanțe destinate pentru curățarea mobiliei.

HU: A bútor felületét csak bútorápoló szerekkel szabad tisztítani.

HR: Površinu namještaja treba čistiti samo sredstvima za njegu namještaja.

SI: Površino pohištva čistite samo s sredstvi za nego pohištva

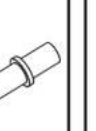
A0  Ø8x30 x16	B1  Ø7x50 x22	B4  x22	C2  x8	C4  x8	C7  16 mm x8	D0  3x15 x16	D4  3.5x16 x4	D5  3.5x16 x12	E0  8x50 x2	F5  060 x2
---	---	--	---	---	--	--	---	--	---	--

J5  x4	K  4mm x1	L21  x2	M1  x14	M3  x2	P0  x2	Q0  x4	U2  x4
---	---	--	--	---	---	---	---

3x15



3.5x16



D0

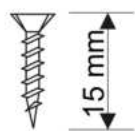

15 mm

D5

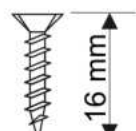

16 mm



3.5x16



D4

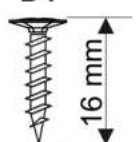

16 mm

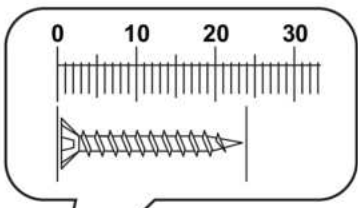
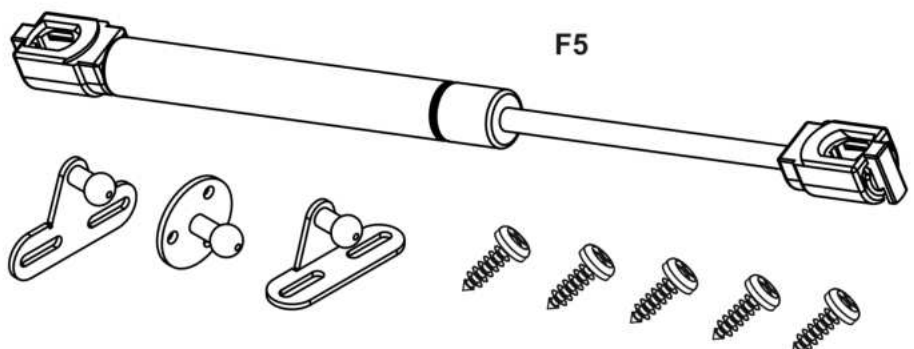
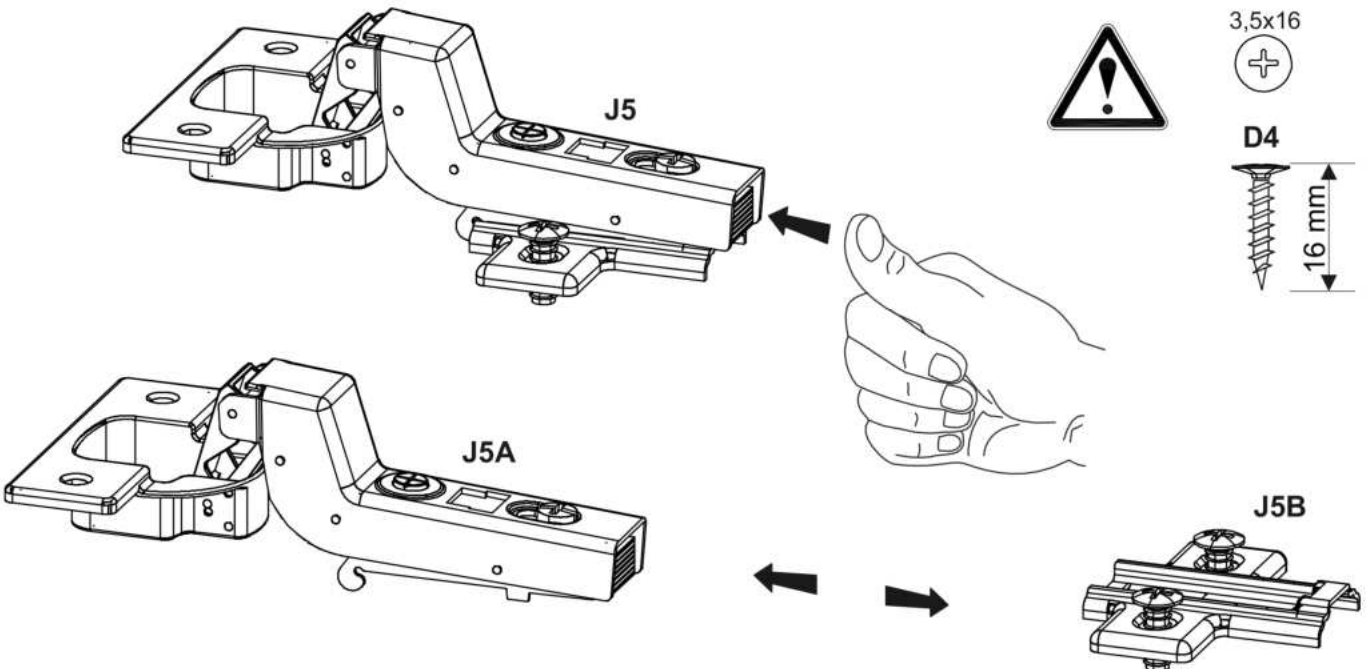

①	1540	390	16 x1	1/1
②	1540	390	16 x1	1/1
③	389	292	16 x1	1/1
④	338	292	16 x1	1/1
⑤	338	292	16 x1	1/1
⑥	389	292	16 x1	1/1
⑦	539	335	16 x1	1/1
⑧	480	286	16 x1	1/1
⑨	480	286	16 x1	1/1
⑩	480	302	3 x2	1/1
⑪	555	302	3 x1	1/1
⑫	210	28	28 x4	1/1
⑬	298	40	18 x2	1/1
⑭	1288	40	18 x2	1/1
				1/1

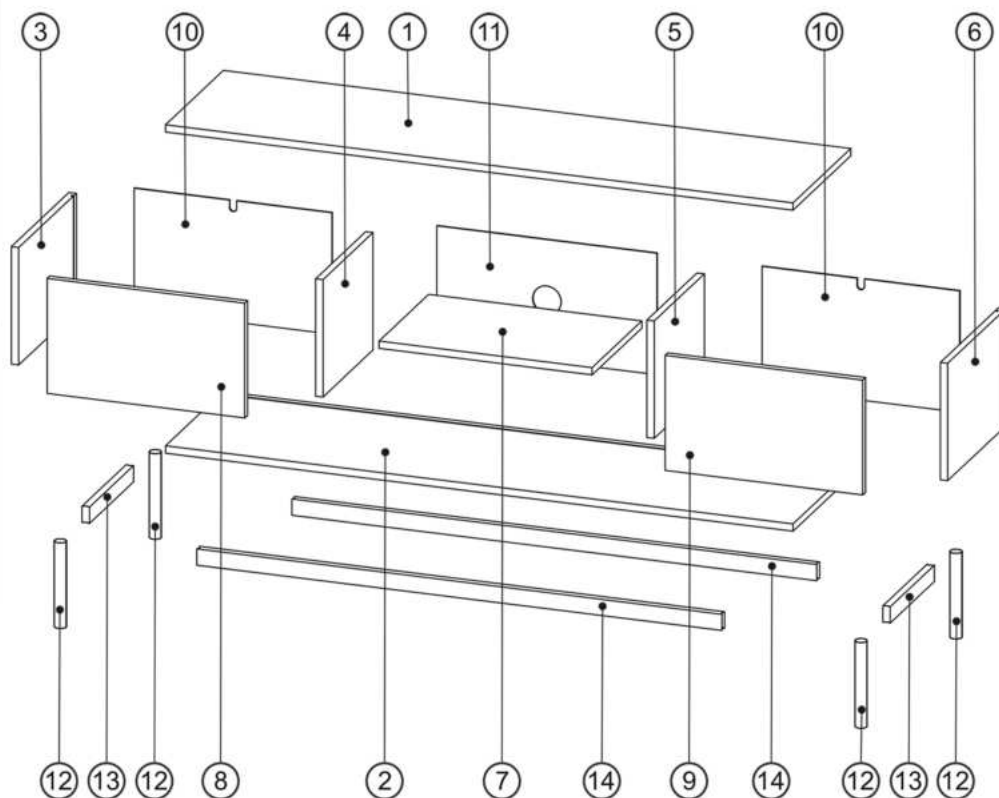
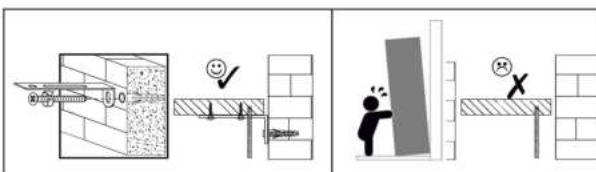

CZ: Připevnění ke stěně

Prosím, nesbírejte nábytek, pokud jsou jeho prvky poškozené. Před montáží je nutné pečlivě prohlédnout jednotlivé prvky nábytku. V případě jejich poškození je třeba je nahlásit spolu s fotodokumentací pro posouzení reklamace a přijetí vhodných opatření.

SK: Pripevnenie na stenu

Prosím, nezbierajte nábytok, ak sú jeho prvky poškodené. Pred montážou je potrebné dôkladne prezrieť jednotlivé prvky nábytku. V prípade ich poškodenia je potrebné nahlásiť ich spolu s fotodokumentáciou pre posúdenie reklamácie a prijatie vhodných opatrení.

RO: Atașați la perete

Vă rugăm să nu colectați mobilier dacă elementele acestuia sunt deteriorate. Înainte de asamblare, este necesar să inspectați cu atenție elementele individuale ale mobilierului. În caz de deteriorare a acestora, trebuie raportat împreună cu documentația foto pentru a lua în considerare reclamația și a lua măsurile corespunzătoare.

HU: A falhoz rögzítés

Kérjük, ne gyűjtse össze a bútorokat, ha azok elemei sérültek. Összeszerelés előtt alaposan meg kell vizsgálni a bútor egyes elemeit. Ha megsérülnek, fényképes dokumentációval együtt be kell jelenteni a panasz mérlegelésére és a megfelelő intézkedések megtételére.

HR: Montaža na zid



Molimo nemojte skupljati namještaj ako su njegovi dijelovi oštećeni. Prije montaže potrebno je pažljivo pregledati pojedine elemente namještaja. U slučaju oštećenja iste potrebno je prijaviti uz fotodokumentaciju kako bi se reklamacija razmotrila i poduzele odgovarajuće mjere.

SI: Pritrdite na steno

Ne zbirajte pohištva, če so njegovi elementi poškodovani. Pred montažo je potrebno natančno pregledati posamezne elemente pohištva. V primeru poškodb le-teh je potrebno prijaviti skupaj s fotodokumentacijo, da se reklamacija obravnava in ustrezno ukrepa.

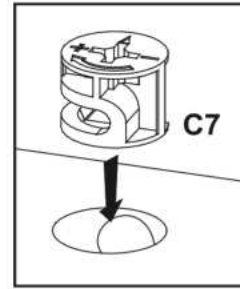
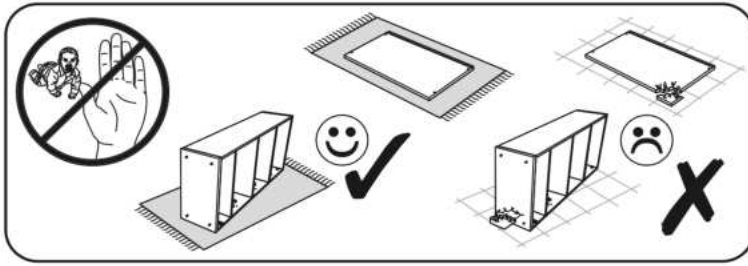
1



A0	C7
	
Ø8x30	16 mm
x16	x8

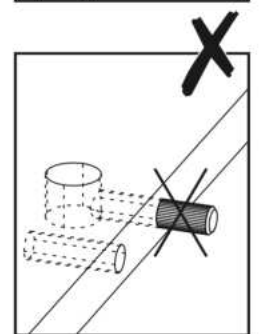
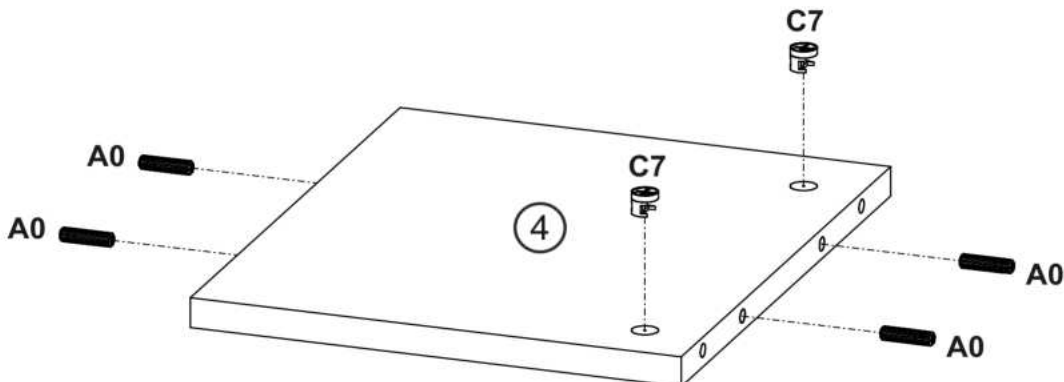
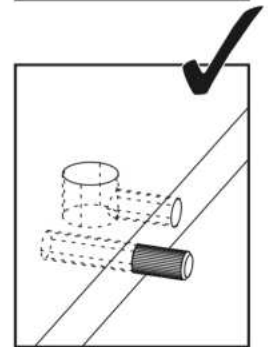
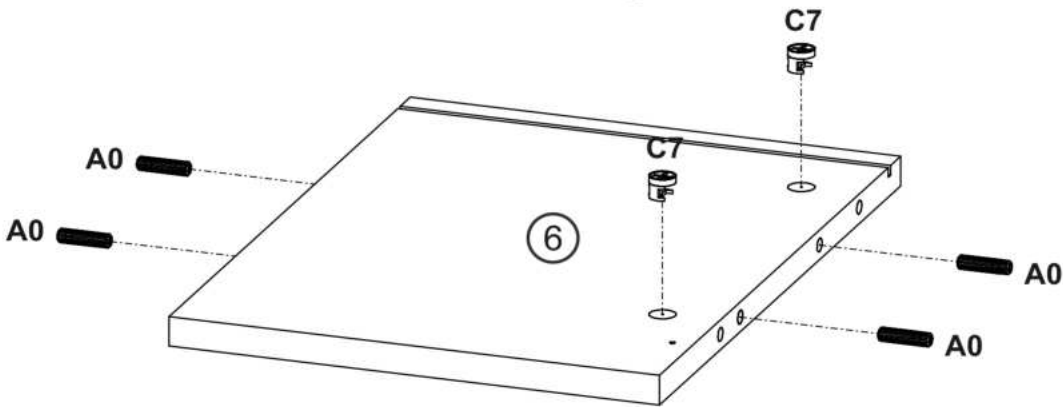
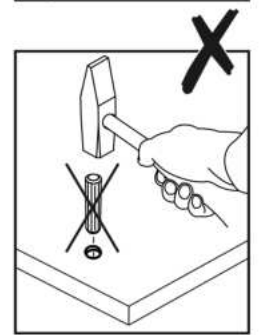
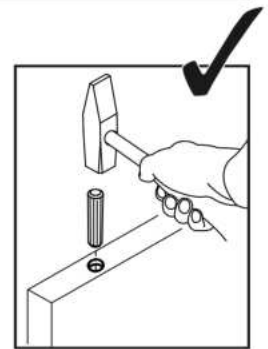
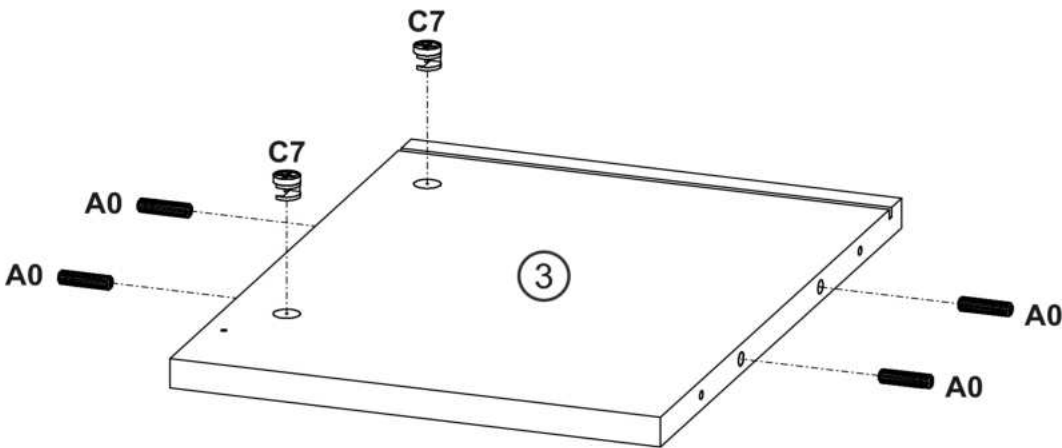
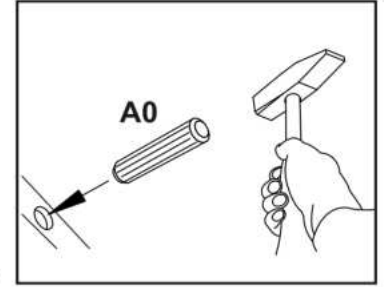
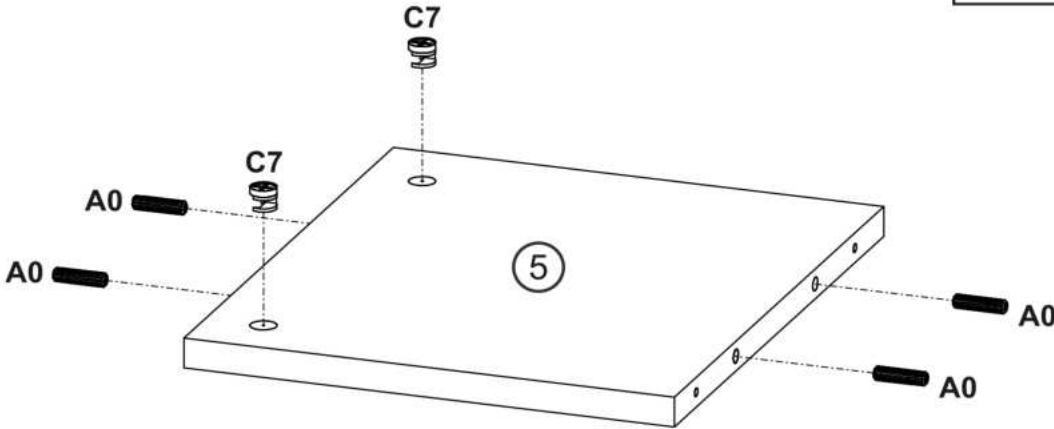

2

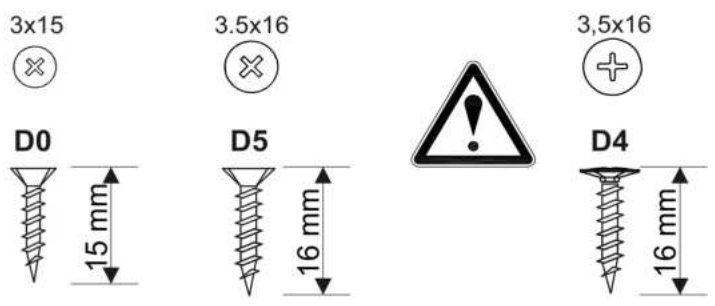

C2 x8	D5 3.5x16 x2	P0 x2
----------------------------	--------------------------------------	----------------------------

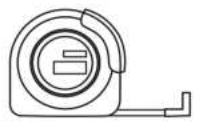
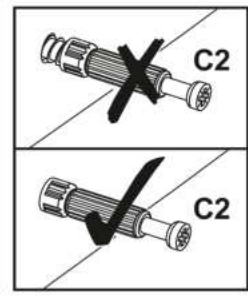
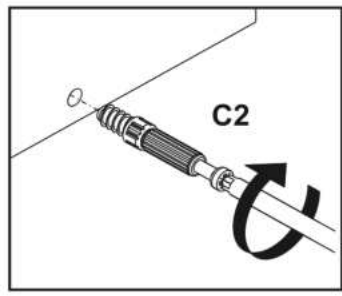
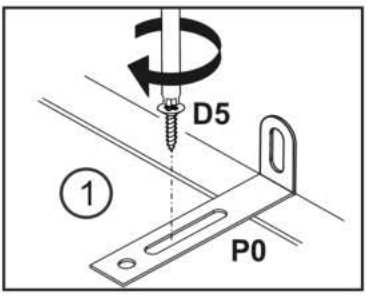
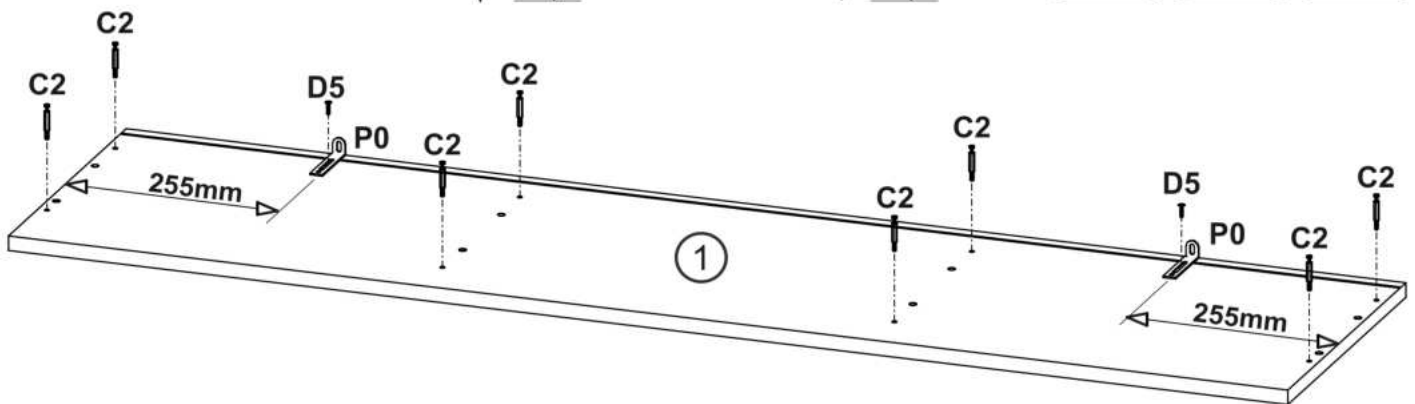

3

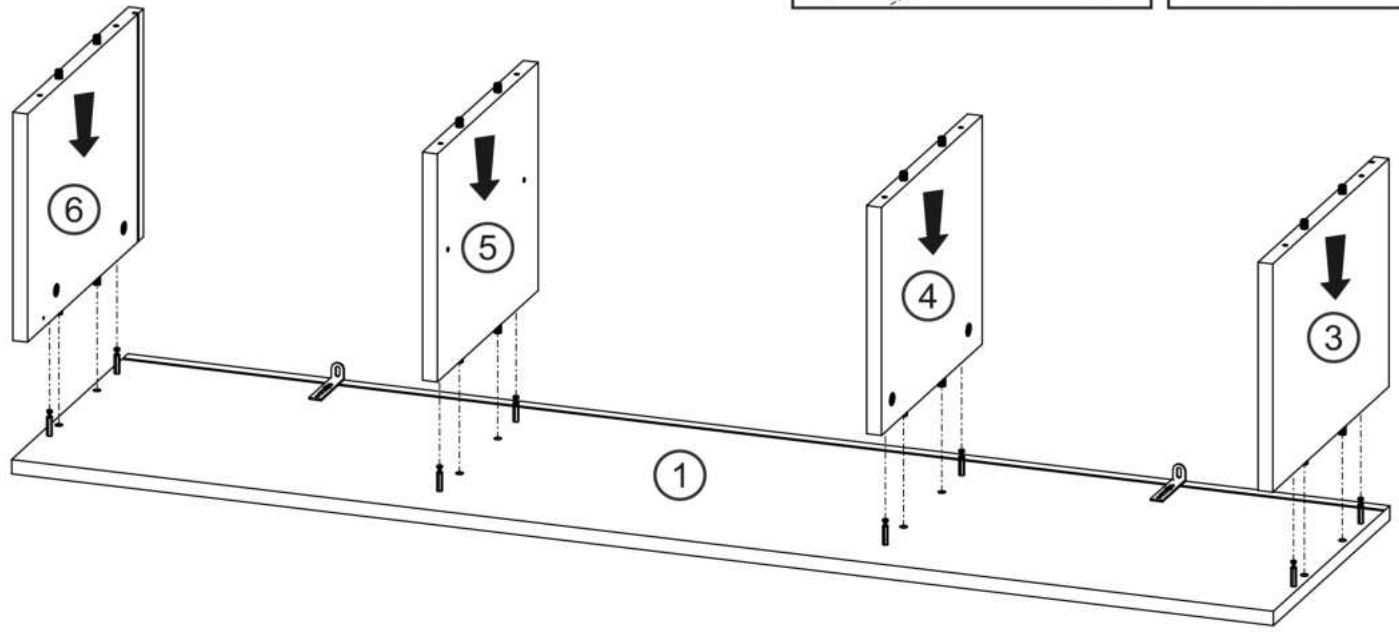
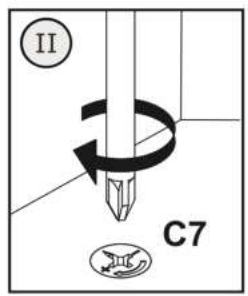
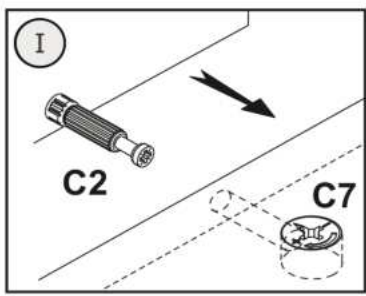

		B1 Ø7x50 x22	B4 x22	C4 x8	J5 x4	K 4mm x1	U2 x4
--	--	----------------------------------	-------------------------	------------------------	------------------------	------------------------------	------------------------

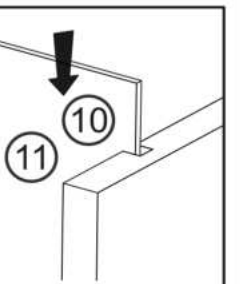
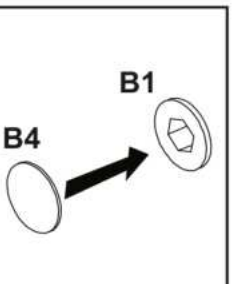
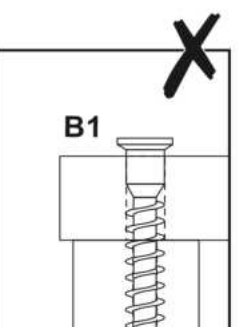
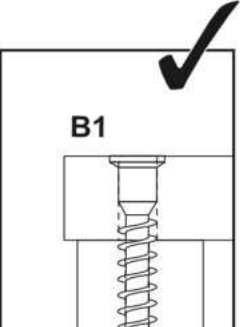
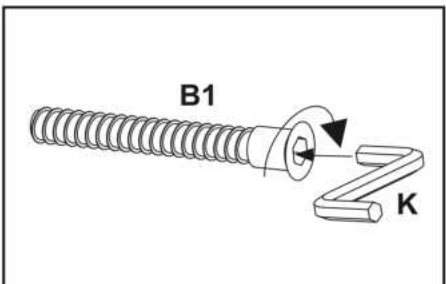
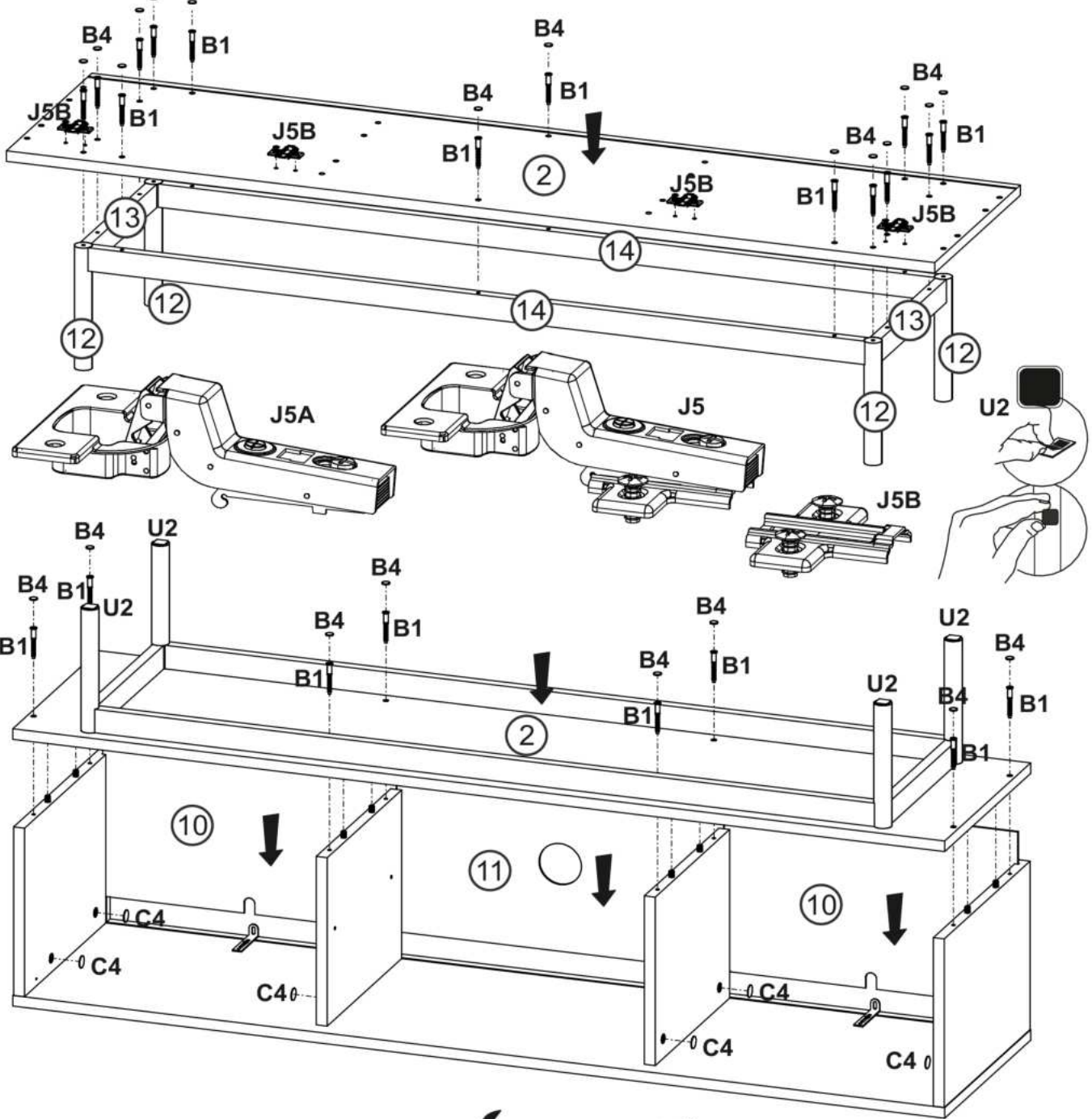

5

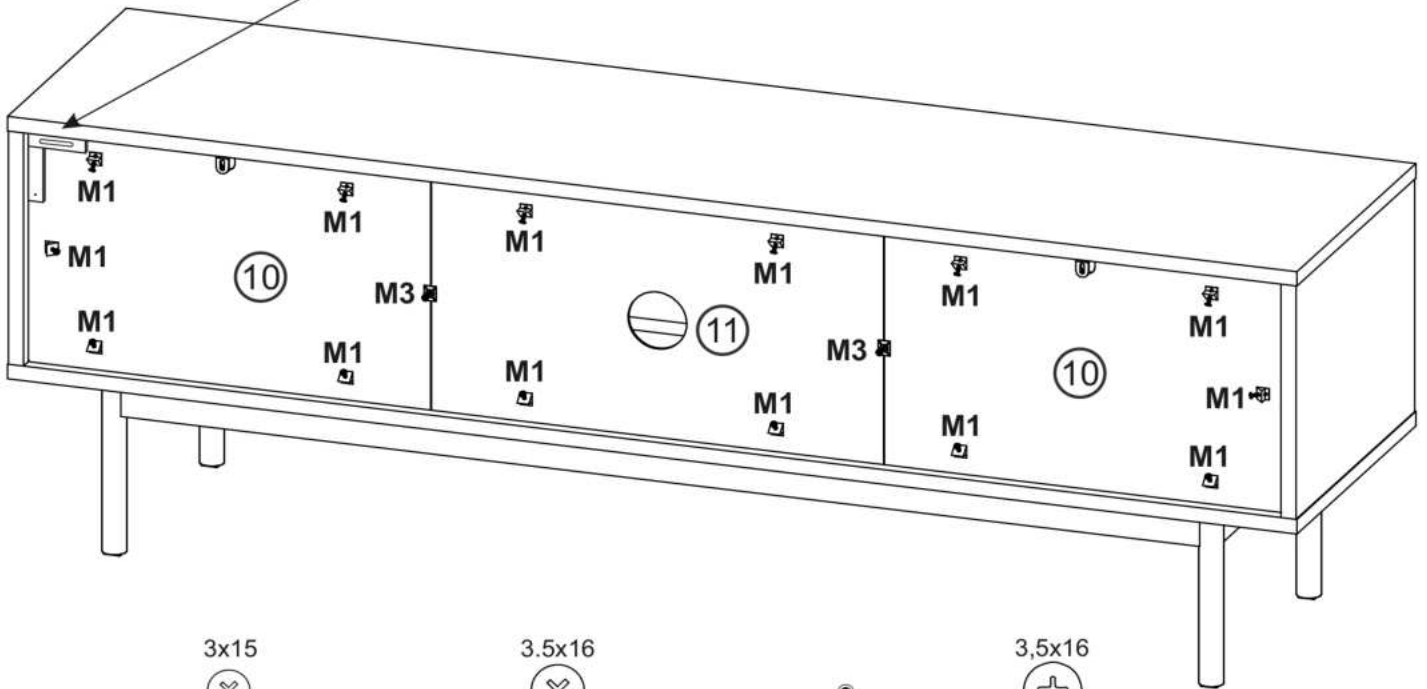
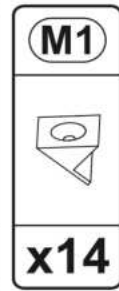
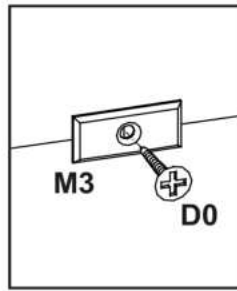
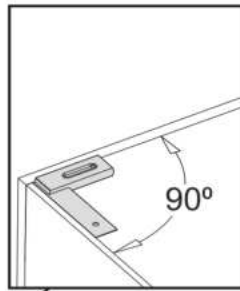

3x15



D0

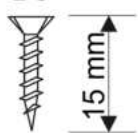

15 mm

3.5x16



D5

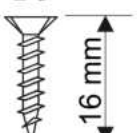

16 mm

3.5x16



D4

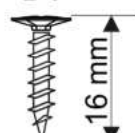

16 mm

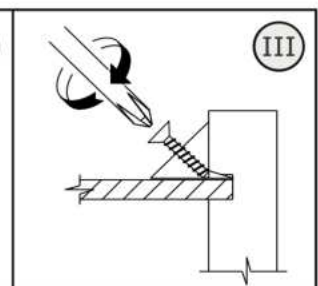
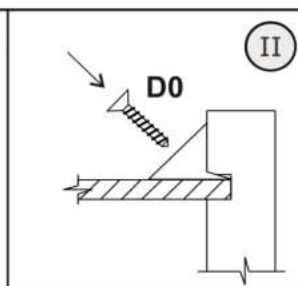
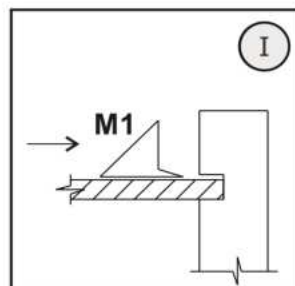
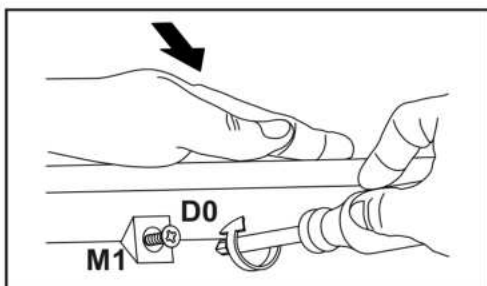
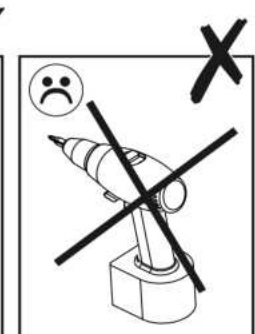
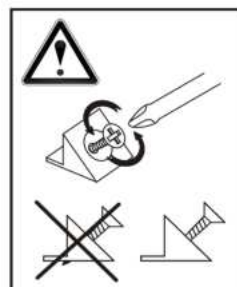
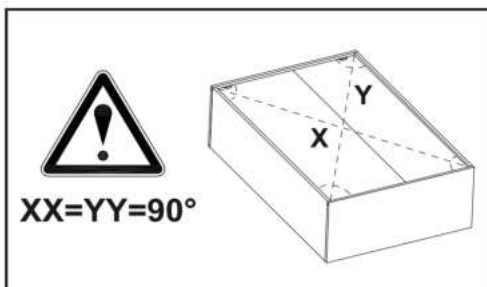

6

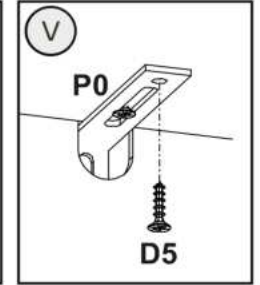
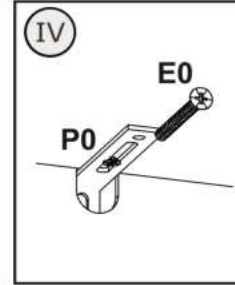
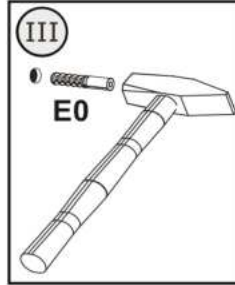
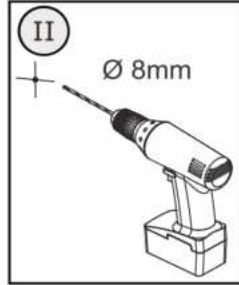
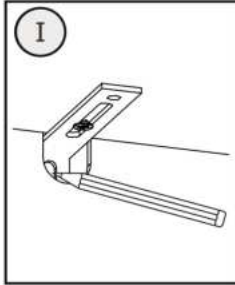
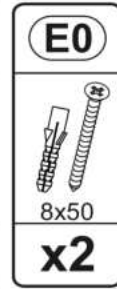
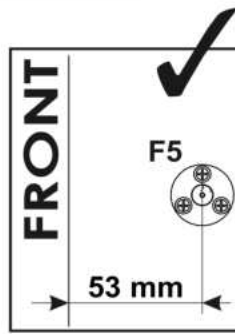
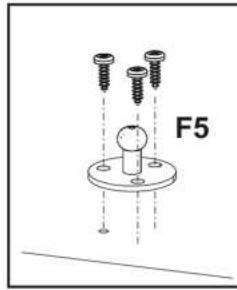
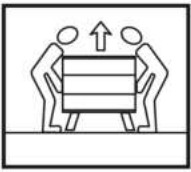

3.5x16





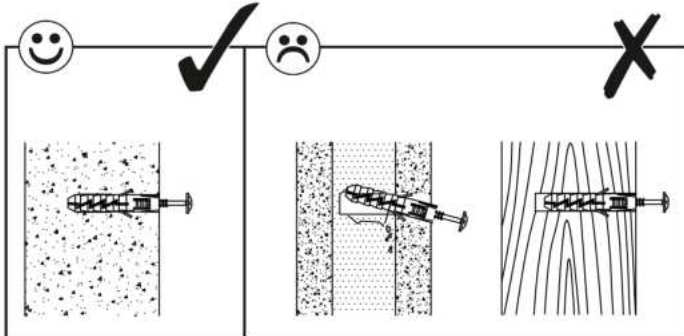
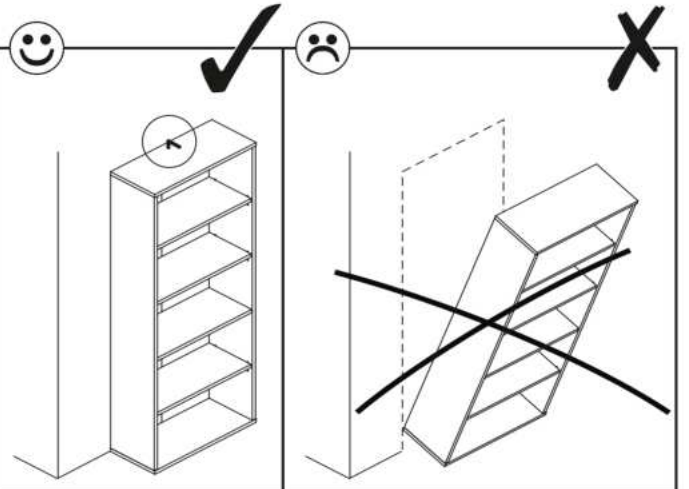
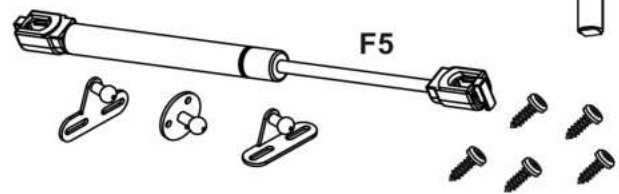
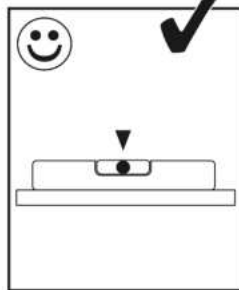
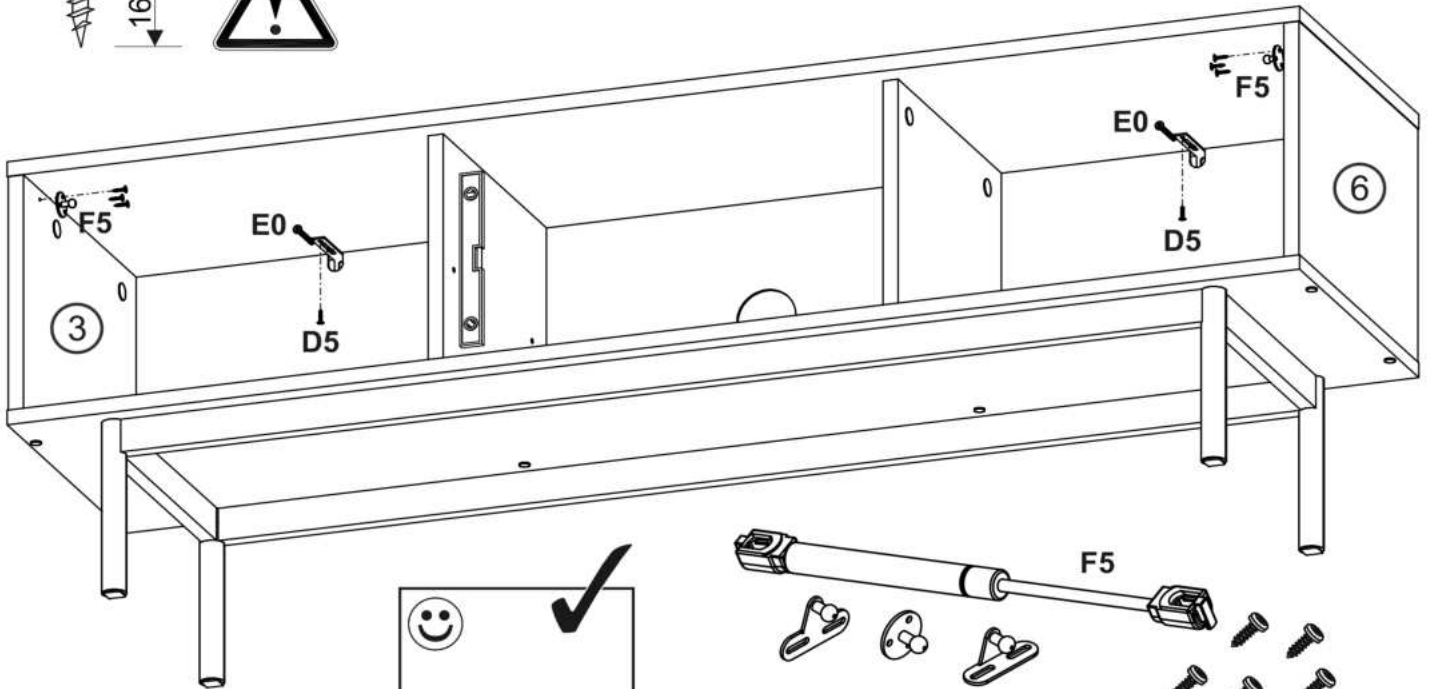
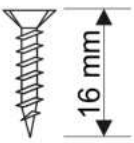

D5

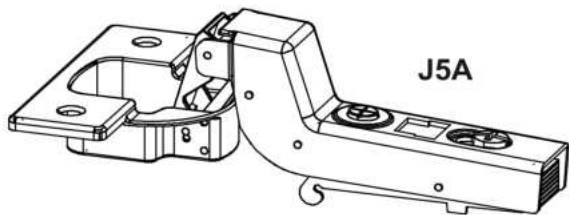

7



D4	D5	J5	F5	L21
				
3.5x16	3.5x16		060	
x4	x8	x4	x2	x2

3,5x16



D4

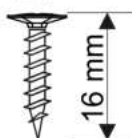

16 mm



3,5x16



D5

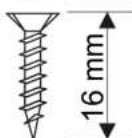

16 mm

