

Features

- Compression valves.
- Pair of angle supplies with stop.
- Annealed vertical tube with union connection.
- 3/8 NPT connection with flange.
- Four-arm handle stop.

Material

- Brass construction.



Codes/Standards

ASME A112.18.1/CSA B125.1

NSF/ANSI 61

NSF/ANSI 372











All applicable US Federal and State material regulations

KOHLER® One-Year Limited Warranty

See website for detailed warranty information.

Available Colors/Finishes

Color tiles intended for reference only.

Color	Code	Description
	CP	Polished Chrome
	SN	Vibrant® Polished Nickel
	AF	Vibrant® French Gold
	PB	Vibrant® Polished Brass
	G	Brushed Chrome
	BN	Vibrant® Brushed Nickel
	BV	Vibrant® Brushed Bronze
	BKB	Brushed Black
	KB	Black Iron
	AU	Polished Gold

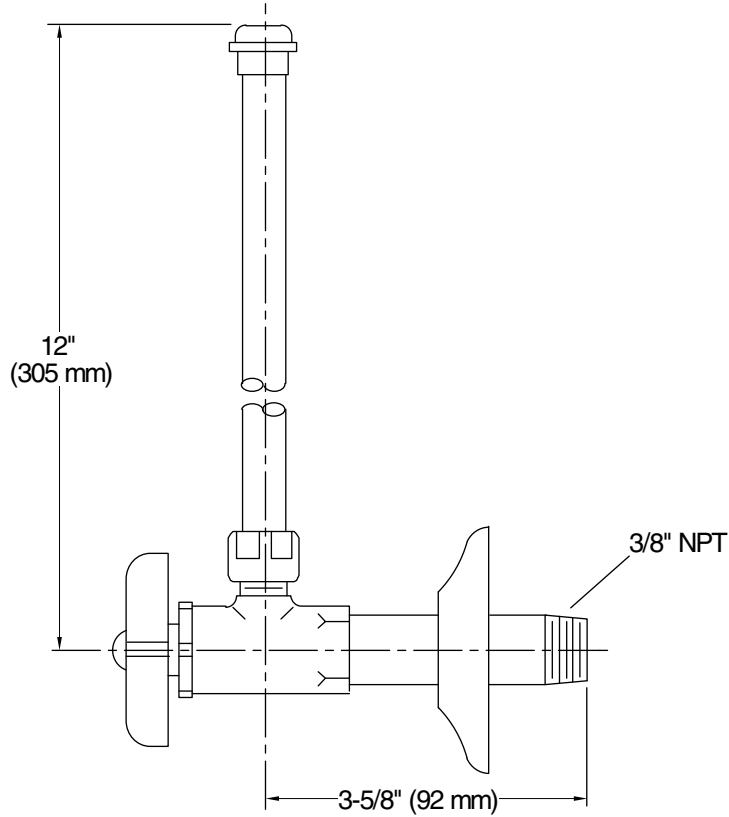

Technical Information

All product dimensions are nominal.

Notes

Install this product according to the installation guide.