

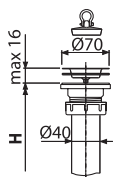

A441 ▫ A441P ▫ A442 ▫ A442P ▫ A443 ▫ A443P A444 ▫ A444P ▫ A446 ▫ A446P ▫ A447 ▫ A447P

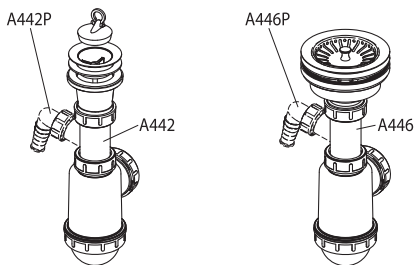

A441: H=100-205
A441P: H=145-205

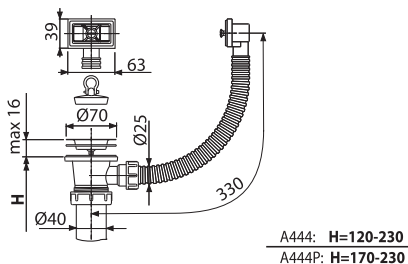
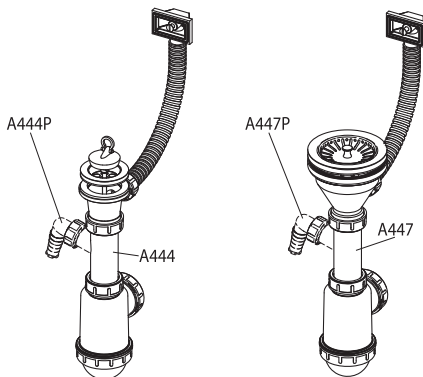
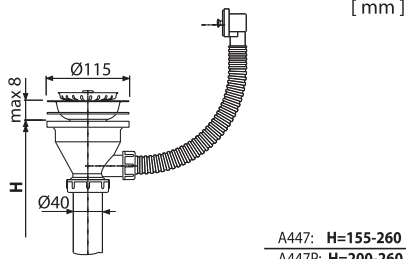
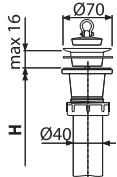

A442: H=120-230
A442P: H=170-230

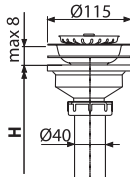

A446: H=120-225
A446P: H=165-225

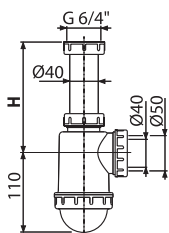

A443: H=70-180

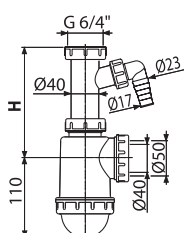

A443P: H=120-180

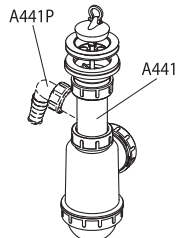
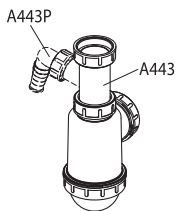

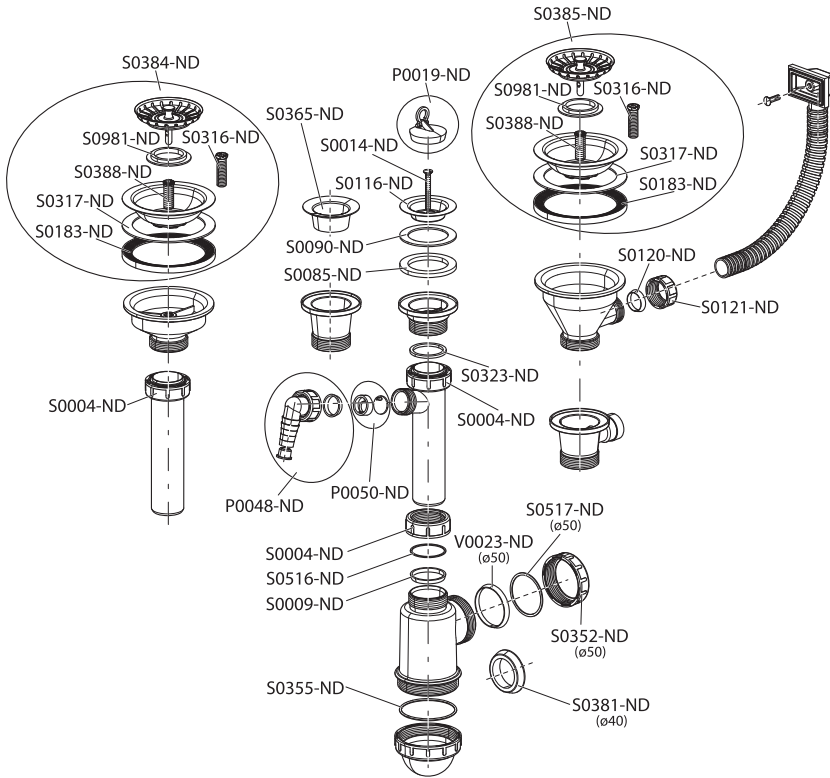

ŽIRAVINA / CAUSTIC

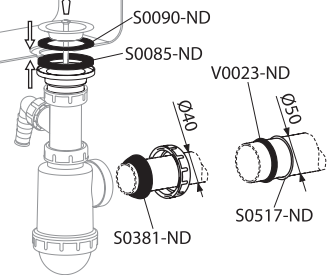
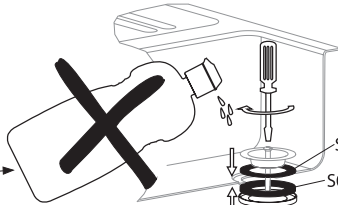

Alca plast, s. r. o.
 Bratislavská 2846, 690 02 Břeclav, Česká republika
 Tel.: +420 519 821 117 – prodej ČR
 Tel.: +420 519 821 041 – export, Fax: +420 519 821 083
 e-mail: alcaplast@alcaplast.cz, www.alcaplast.cz