

19289

DE	MONTAGEANLEITUNG:	DREHTÜR IN NISCHE	PL	INSTRUKCJA MONTAŻU:	DRZWI OBROTOWE
GB	INSTALLATION INSTRUCTIONS:	PIVOT DOOR	SK	NÁVOD NA MONTÁŽ:	JEDNOKRÍDLOVÉ DVERE
FR	NOTICE DE MONTAGE:	PORTE PIVOTANTE POUR MONTAGE EN NICHE	RU	ИНСТРУКЦИЯ ПО МОНТАЖУ:	РАСПАШНАЯ ДВЕРЬ
CZ	NÁVOD K MONTÁŽI:	JEDNOKRÍDLÉ DVEŘE	ES	INSTRUCCIONES DE MONTAJE:	PUERTA ABATIBLE

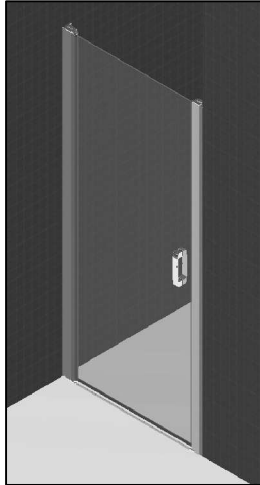

Benötigtes Werkzeug:

Necessary tools:

Outil Nécessaire:

Nářadí potřebné pro montáž:

Potrzebne narzēdzia:

Potrebné náradie:

необходимые инструменты:

Herramientas necesarias:



1x

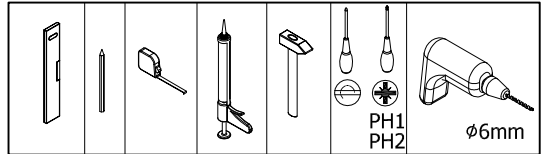

PH1
PH2

ø6mm

42356

51402

2x62100

50402

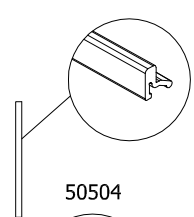
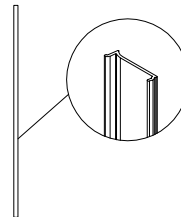
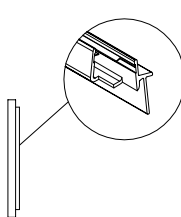
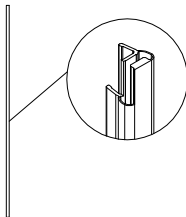
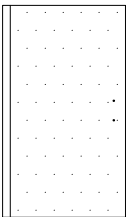

50504



50400Exx.xxxx

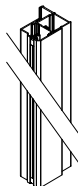



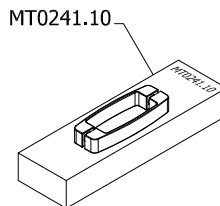



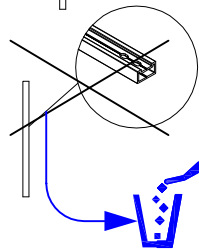



50518Exx.xxxx







MT0241.10







U

 1 x 11221	 2 x 14016 3.5 x 22mm	 1 x 14019 3.5 x 16mm	 2 x 14027 M4 x 25mm	 6 x 14118 4.2 x 32mm	 6 x 16000 ø 6mm
 4 x 51317	 1 x 51541	 1 x 54400	 1 x 54401	 1 x 17158	

D

 1 x 51232	 1 x 51696	 1 x 51797	 1 x 51798
--	--	--	--

G

 1 x 51233	 1 x 51695	 1 x 51796	 1 x 51799
--	--	--	--

Zubehör:
Equipment:
Accessoires:
Příslušenství:
Dodatki:
Príslušenstvo:
Аксессуары:
Accesorios:

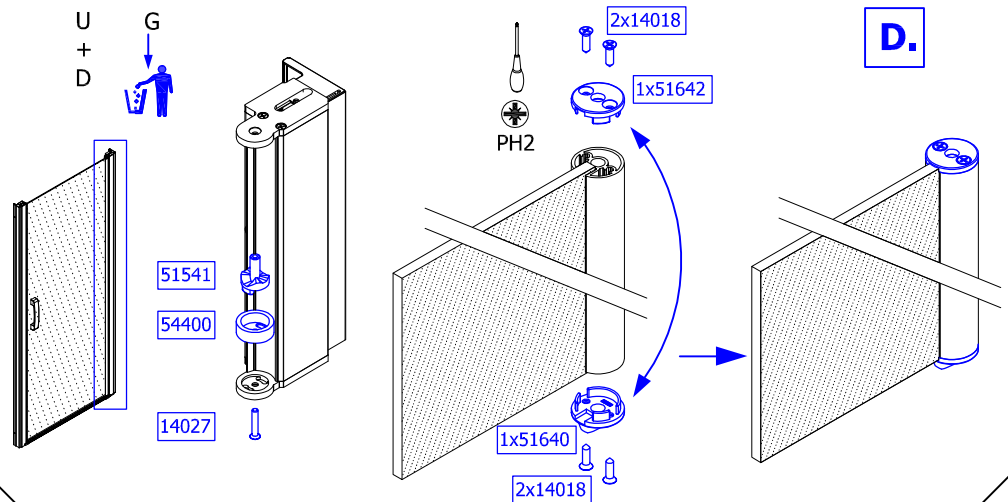
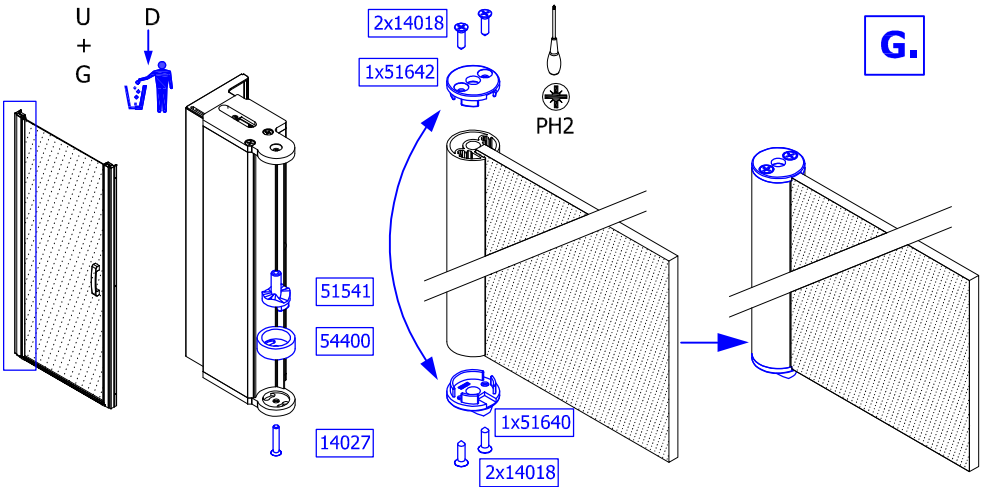

1.

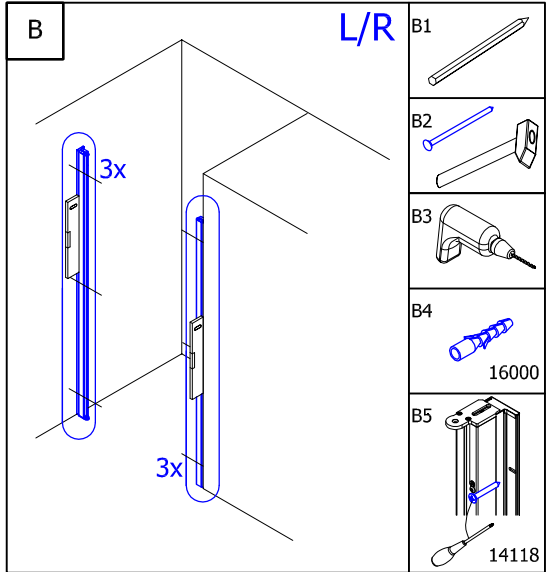
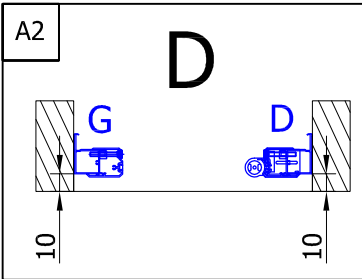
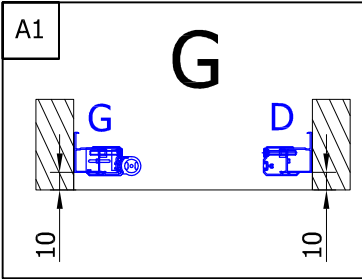

2.

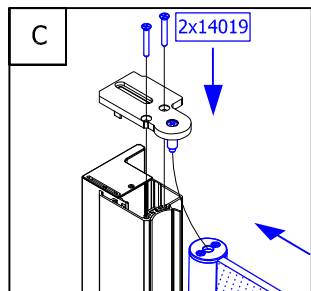
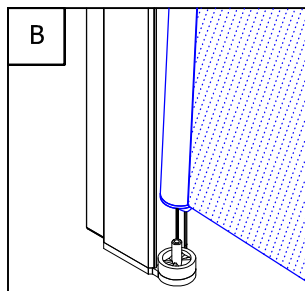
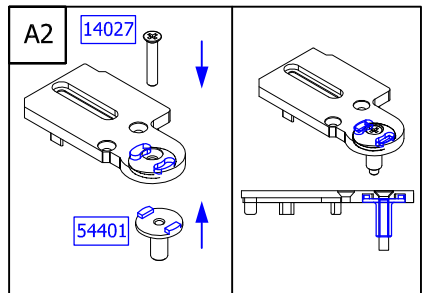
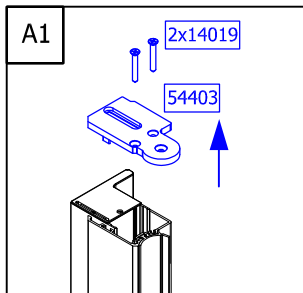
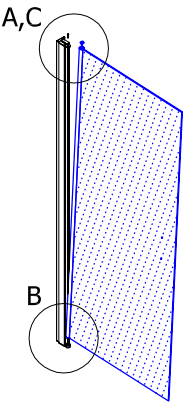

MT0241.10

3.

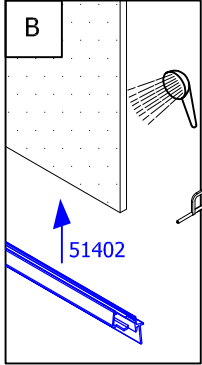
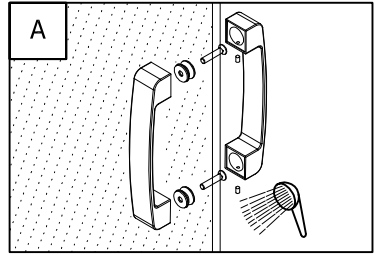
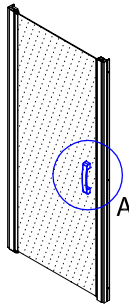
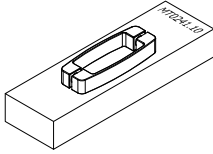

D/G 51402

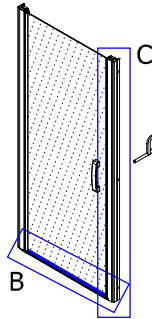
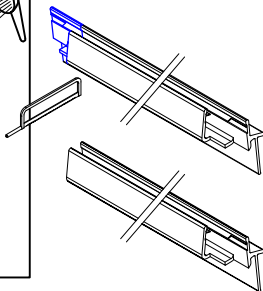

42356

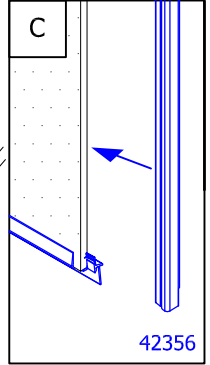
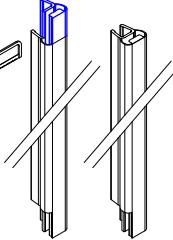

42356

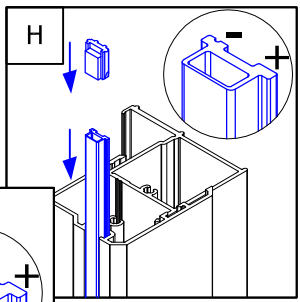
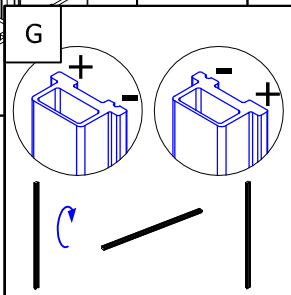
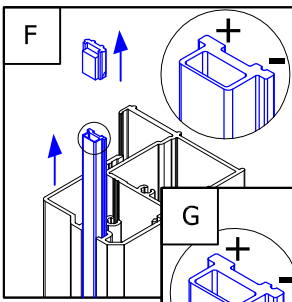
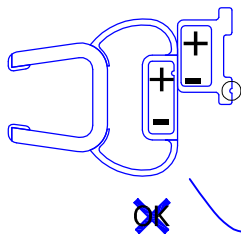
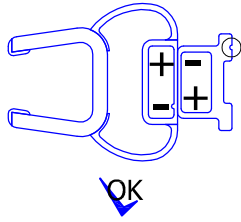
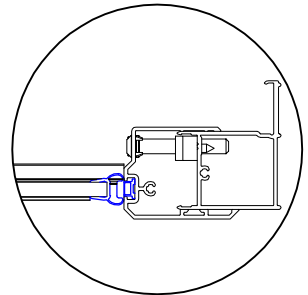
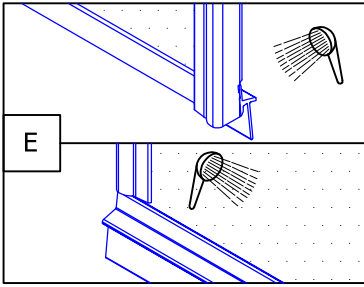
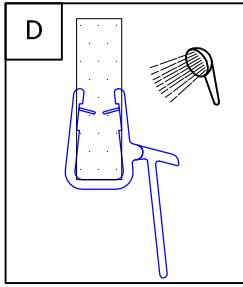

max.25mm

max.25mm

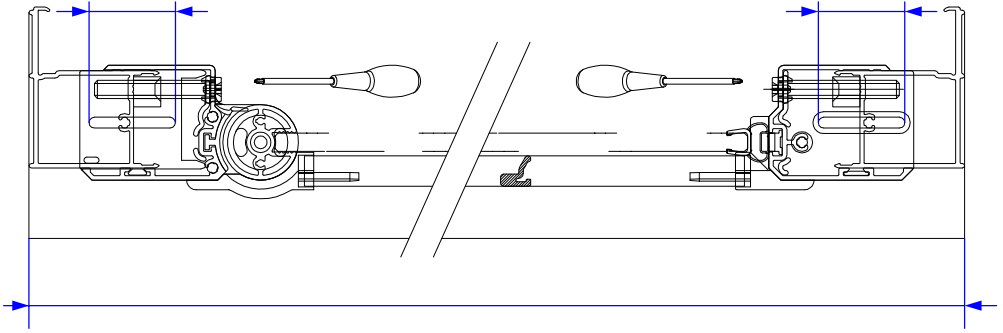

4.

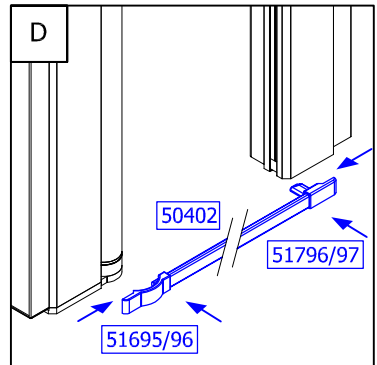
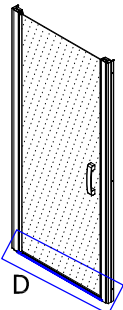
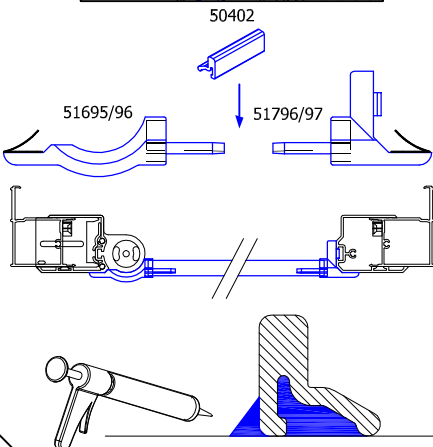
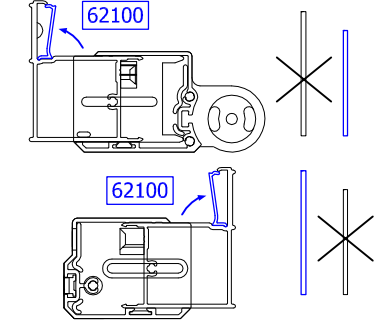
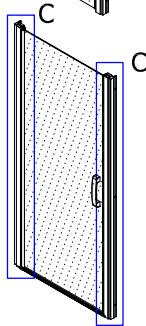
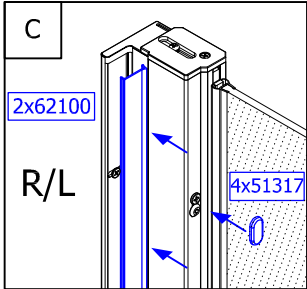
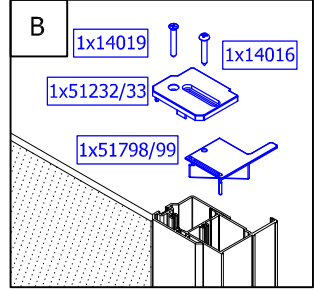
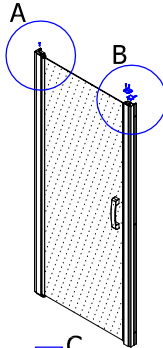
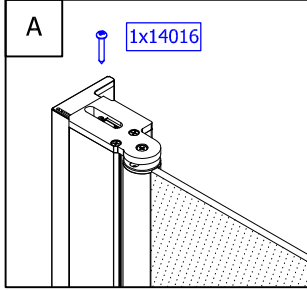

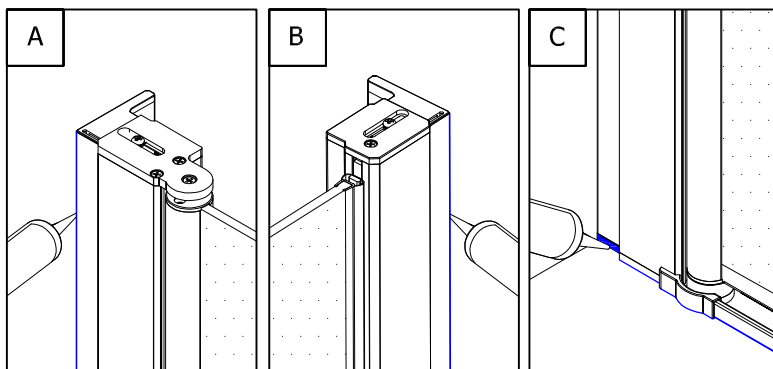
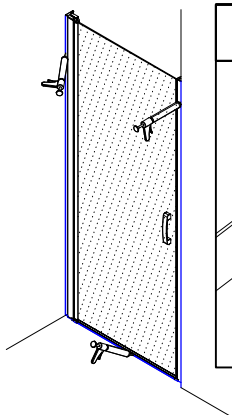

Achtung! Nur Sanitär-Silikon - bakterizid und fungizid eingestellt verwenden.

Caution! Use only bactericidal and fungicide sanitary silicone.

Attention! N'utiliser que du silicone sanitaire bactéricide et fongicide.

Pozor! Používejte pouze baktericidní a fungicidní sanitární silikon.

Uwaga! Stosować tylko sylikon sanitarny - bakterio i grzybobójczy.

Pozor! Užívajte pouze baktericidný a fungicidný sanitárny silikón.

Внимание! Применяйте только антибактериальные силиконовые герметики с фунгицидом

Cuidado! Utilizar solamente silicona sanitaria bactericida y fungicida.

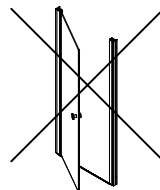
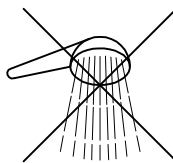

5.

6.

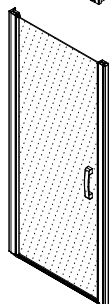
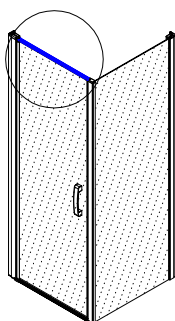

50504

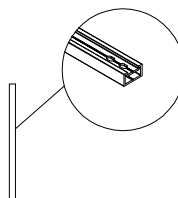

50504

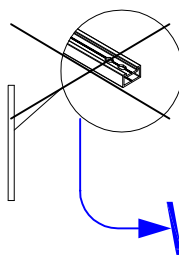

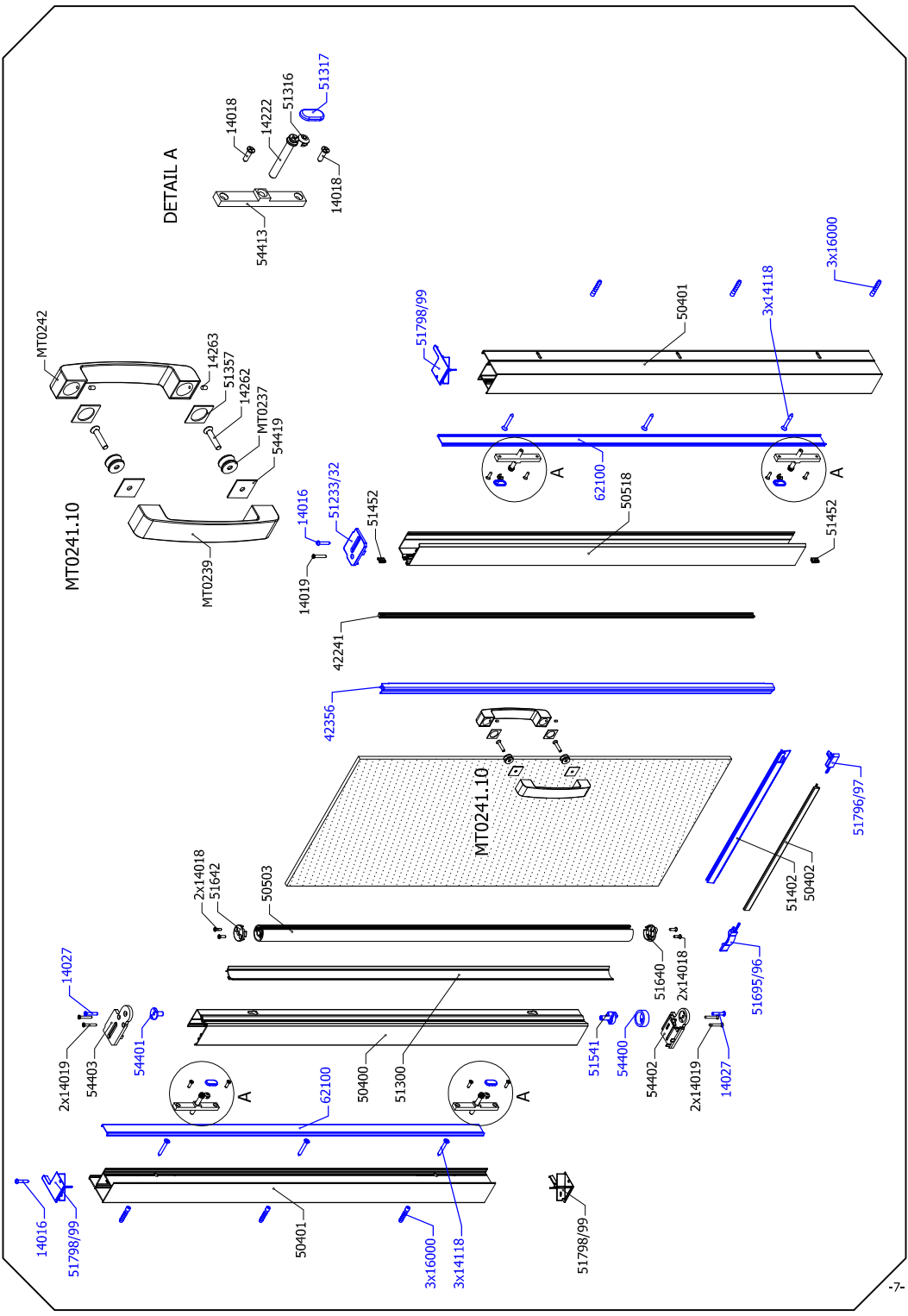

DETAIL A

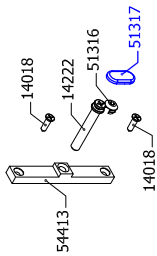

QUALITY CONTROL:

- D** Dieses Produkt wurde unter sorgfältiger Beachtung der Qualitäts-Richtlinien gefertigt und vor dem Verpacken einer eingehenden Prüfung unterzogen. Sollten Sie dennoch einen Produktmangel oder eine Beschädigung feststellen, so setzen Sie sich bitte direkt mit der Firma in Verbindung, bei der Sie dieses Produkt gekauft haben.
- GB** This product was made with careful attention to quality guidelines and was subjected to a thorough examination before packaging. However, if you find a product defect or damage so please get in touch directly with the company in which you have bought this product.
- F** Ce produit est fabriqué avec une attention particulière selon des normes de qualité et est soumis à un contrôle approfondi avant l'emballage. Toutefois, si le produit présente un défaut ou un dommage, veuillez prendre contact avec l'entreprise qui vous a vendu ce produit.
- CZ** Tento produkt byl vyroben s odbornou péčí podle příslušných kvalitativních směrnic a před zabalením byl důkladně zkontrolován. Pokud u něho přesto zjistíte závadu nebo poškození, kontaktujte prosím firmu, u které jste výrobek zakoupili.
- PL** Produkt ten został wyprodukowany z uwzględnieniem rygorystycznych norm jakościowych, a następnie podany drobiazgowej kontroli przed zapakowaniem. Jeżeli po rozpakowaniu (przed rozpoczęciem montażu!) stwierdzicie Państwo wady lub uszkodzenia to prosimy o natychmiastowe zgłoszenie tego faktu sprzedawcy.
- SK** Tento produkt bol vyrobený s odbornou starostlivosťou podľa príslušných kvalitatívnych smerníc a pred zabalením bol dôkladne skontrolovaný. Ak u neho aj napriek tomu zistíte závadu alebo poškodenie, kontaktujte prosím firmu, u ktorej ste výrobok zakúpili.
- RU** Это изделие было изготовлено с особым вниманием в соответствии с высокими стандартами качества и было тщательно проверено перед упаковкой. В то же время, если вы обнаружите дефект или повреждение, обратитесь в компанию, у которой вы купили это изделие.
- E** Este producto ha sido fabricado cumpliendo estrictamente las normativas de calidad y ha sido sometido a un control exhaustivo antes de embalarlo. En caso de que a pesar de ello, Usted note algún desperfecto del producto, rogamos se ponga en contacto directamente con la empresa donde haya comprado el producto.
- RO** Acest produs a fost fabricat respectând cele mai stricte norme de calitate, iar produsul a fost testat înainte de a fi împachetat. Dacă totuși observați o neregulă sau o defecțiune, vă rugăm să contactați direct firma de la care ați achiziționat produsul.

.....
.....
.....
.....
.....

