

COMO SZZ 100

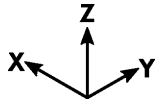

X: 0mm

Y: 0mm

Z: 0mm

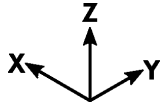

X: 1000 mm

Y: 520 mm

Z: 338 mm

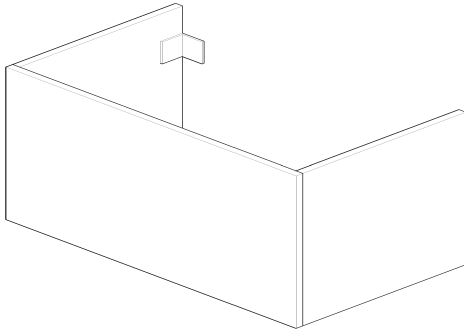

- A 550 mm
- B 600 mm
- C 80-120 mm
- D 500 mm
- E --- mm
- F --- mm
- G 766 mm
- H --- mm
- I --- mm
- J 860 mm
- M mm
- N mm

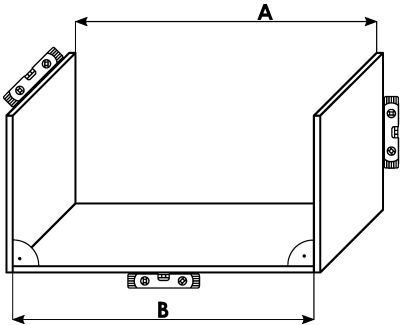
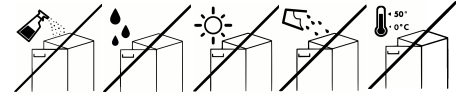
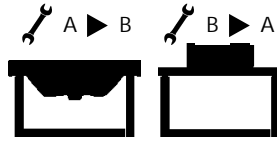
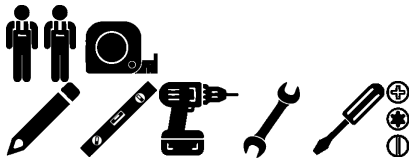
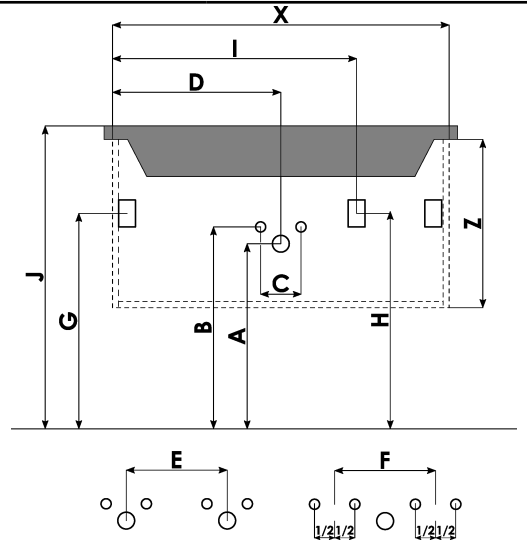

! A=B

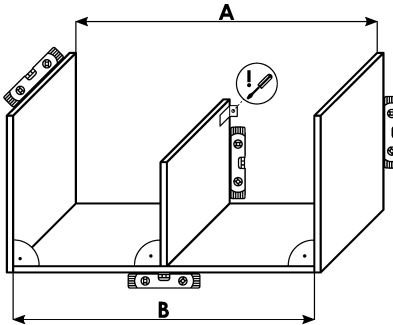

A

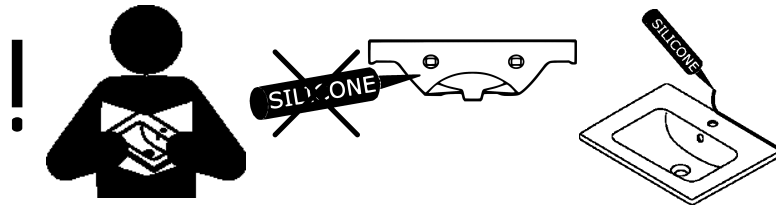

B

