



ADVANCED FLOW
SYSTEMS™



ULTRA SILENT™

odhlučňené kanalizační potrubní systémy





Popis ultra tichého systému

Odhlučňný třívrstvý systém, tvořený trubkami a tvarovkami pro odvedení odpadních vod při nízkých i vysokých teplotách, a to jak uvnitř budovy tak i mimo stavební objekt.

Trubky mají třívrstvou strukturu stěny s vnější a vnitřní vrstvou polypropylenu (PP) a střední vrstvou z minerálně zesíleného polypropylenu (PP-MD). Tvarovky jsou vyrobeny z minerálně zesíleného polypropylenu (PP-MD). Materiál neobsahuje halogen ani kadmium.

Násuvné hrdlo s vloženým těsnícím kroužkem s břitem.

Vhodné pro odvedení odpadních vod, v souladu s normou DIN 8078, s pH mezi 2 a 12 při atmosférickém tlaku a v maximální provozní teplotě mezi 95°C a 98°C, krátkodobě.

Vhodné také pro stavbu ventilací, odvedení dešťové vody a vakuový systém. Lze použít v prostředí, kde teplota neklesla pod -25°C.

Systém má hladinu zvuku L_{sc, A} o 15db(A) při rychlosti průtoku 2l/s, změřeného v souladu s normou EN 14366 a certifikovaného institutem Fraunhofer Institut Für Bauphysik ve Stuttgartě (n° P-BA 78-81/2012e). Tento test se provádí za použití běžných komerčních ocelových úchytek s elastomerní vložkou.

Protipožární vlastnosti odpovídají stupni D-s2, d2, v souladu s normou EN 13501-1.

Ultra tichý systém je certifikován SKZ laboratořemi v Německu, Dánským technologickým institutem (DTI), ENEOR - španělským a izraelským normovým institutem (SII), v souladu s normou EN-1451-1 „Plastový potrubní systém pro odvodnění pozemků a odvedení odpadních vod (nízké a vysoké teploty) z budov“. Ultra tichý systém je certifikován pro pokládku uvnitř i mimo stavební objekt.



Výhody použití ultra tichého systému

- Vynikající akustické vlastnosti: 15dB(A) při průtokové rychlosti 2l/s, v souladu s EN 14366 se standardním uchycením
- Vysoká odolnost proti nárazům i při nízké teplotě (-25°)
- Vynikající odolnost vůči vysokým teplotám: dlouhodobé působení do 95°C, krátkodobé působení do 98°C
- Vysoká chemická odolnost
- Zvýšená hloubka hrdla pro stabilní montáž
- Odbočka s pozvolným úhlem a optimalizovanou konstrukcí pro hladší a zvýšený tok
- Široká řada průměrů: DN 32mm až DN 200mm
- Vysoká odolnost proti UV záření díky černé barvě vnější vrstvy
- Recyklovatelnost: ultra tiché výrobky mají zelený štítek ekologicky šetrných výrobků
- 10 let záruka



Technické parametry a specifikace

Vlastnosti	Hodnota	Testovací metody
Aplikace	Systém pro odvodnění pozemků a odvedení odpadních vod uvnitř budov i mimo stavební objekt, pro výstavbu ventilací, odvedení dešťové vody a centrální vysavače. Ultra tichý systém je certifikován pro pokládku uvnitř i mimo stavební objekt. Lze jej použít od rodinného domu až po velké objekty.	
Materiál potrubí	Kopolymer PP, vnější vrstva černá a vnitřní vrstva bílá. Střední bílá vrstva, sloučenina polypropylenu a minerálních látek.	
Montážní materiál	PP a PP-MD	
Připojení	Hrdlo s elastomerovým gumovým těsněním	
Těsnicí materiál	SBR-NR guma	
Barva	Černá	
Průměr	32-200 mm	
Hustota	Trubky: 1.3-1.4 g/cm ³ Fitinky: 1.18 g/cm ³	
Moduly pružnosti	2.300 – 3.000 N/mm ²	ISO 178
Prodloužení	0,09 mm/m • C°	
Kruhová tuhost	SN6 (> 6.0 kN/m ²)	ISO 9969
Halogenový a kadmiový obsah	Neobsahuje halogen ani kadmium	
Chemická odolnost	Vypouštění média mezi pH2 a pH12	DIN 8078
Minimální provozní teplota	-25°C	
Teplota odpadní vody (max.)	+98° (krátkodobé působení) +95° (dlouhodobé působení)	
Odolnost proti žáru	D-s2, d2 B2	EN 13501-1 EN 4102-1
Odolnost proti UV záření	Vhodné pro venkovní instalaci pokud je chráněno před vystavování se přímému slunečnímu záření (například prostřednictvím speciálního UV ochranného nátěru), může být skladováno venku po dobu až dvou let.	
Akustický výkon	L _{sc,A} = 15 dB(A) při 2l/s, měřeno se standardními objímkami v suterénu za instalační stěnou. L _{in} = 18 dB(A) při 2l/s, měřeno se standardními objímkami v suterénu za instalační stěnou.	EN 14366 DIN 4109
Standardní konstrukce/stavby	EN 1451-1	

Akustický výkon

Ultra Silent™ Tlumení hluku L_{SCA} EN 14366

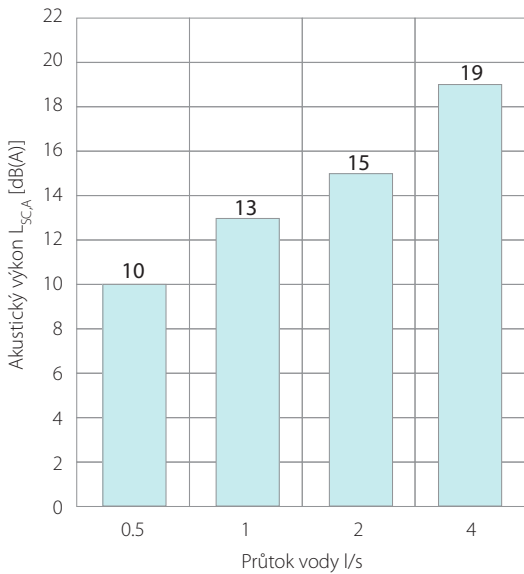

Ultra Silent™ Tlumení hluku L_{IN} DIN 4109

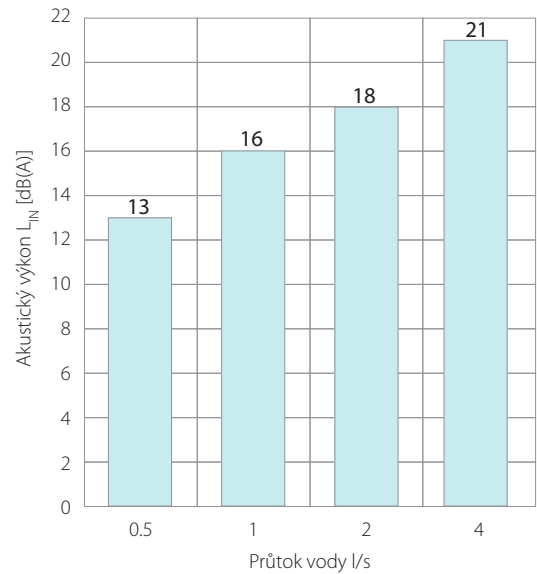

Certifikát P-BA 78/2012e

Diagramy úrovně zvuku vyplývající z Franhoferova testu, podle norem DIN 14366 a DIN 4109. Test se provádí za použití standardních ocelových úchytek s elastomerní vložkou.

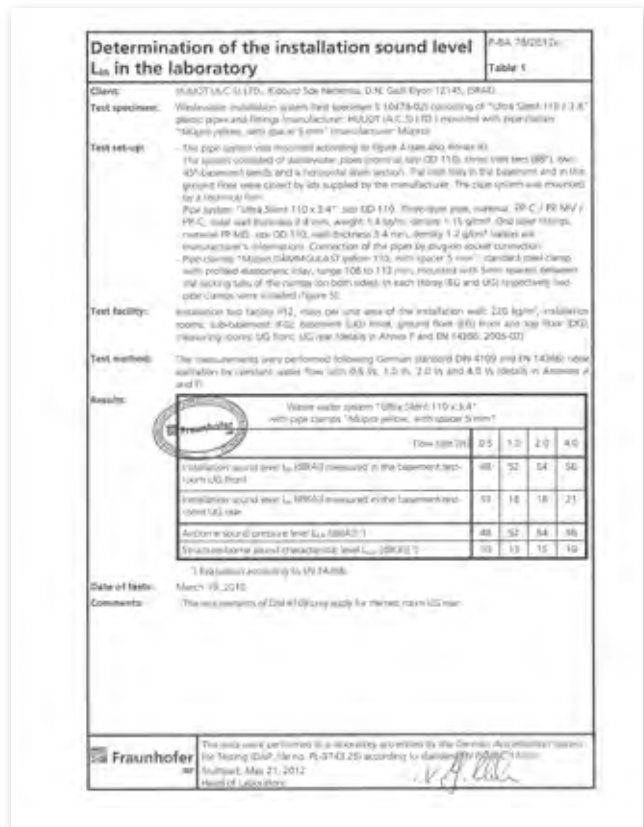
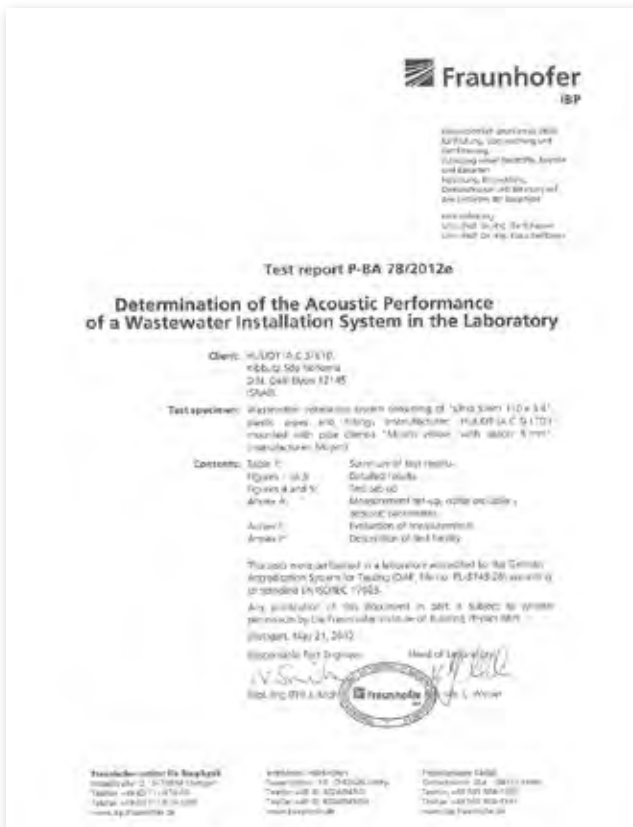

Certifikáty a osvědčení



ZERTIFIKAT **SKZ**

Certificate

SKZ - TeConA GmbH awards the following company

HULIOT A.C.S. Ltd.
Kibbutz Sde Nehemia
12145 D.N. GALIL ELYON
ISRAEL

Production plant: HULIOT A.C.S. Ltd. 12145 D.N. GALIL ELYON

the right to use the SKZ testing and inspection mark

A 624

for the following plastic products

Waste water pipes and fittings, group 1 and 2
Pipes made of polypropylene PP-PP-MD-PP
Fittings made of polypropylene PP-MD
within the building structure
Trade name: GIL 114 501 W

SKZ specification for tests and inspection **HR 3.43**

Users of the SKZ mark are obliged to observe the required regulations for the production and testing of these products.

Date of initial certification: ---
 Date of expiry: 24 February 2015

 i.V. 
 Würzburg, 20 February 2015 Certification body

The original language of this certificate is German. In case of doubt, the German version is obligatory.

ZERTIFIKAT **SKZ**

Certificate

SKZ - TeConA GmbH awards the following company

HULIOT D.O.O.
Vrhniška cesta 30
1354 HORJUL
SLOVENIEN

Production plant: HULIOT D.O.O., SI-1354 HORJUL

the right to use the SKZ testing and inspection mark

A 676

for the following plastic products

Waste water pipes made of polypropylene PP-ML-MD,
group 1 and 2

SKZ specification for tests and inspection **HR 3.43**

Users of the SKZ mark are obliged to observe the required regulations for the production and testing of these products.

Date of initial certification: ---
 Date of expiry: 27 April 2020

 i.V. 
 Würzburg, 20 April 2015 Certification body

The original language of this certificate is German. In case of doubt, the German version is obligatory.

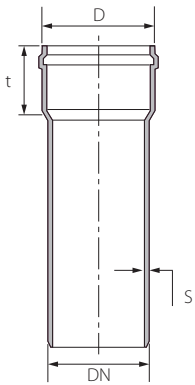

Trubky



DN	D	S	t	S Class
32	45	1,8	42	S16
40	55	1,8	44	S16
50	65	1,8	46	S16
75	90	2,3	49	S16
90	107	2,8	54	S16
110	130	3,4	65	S16
125	149	3,9	72	S16
160	186	4,9	75	S16
200	228	6,2	108	S16

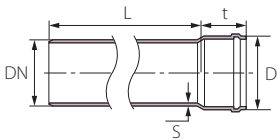

USEM jednohrdlá trubka



Kód	DN	L	D	S	t		
5753200015	32	150	45	1,8	42	20	1440
5753200025	32	250	45	1,8	42	20	960
5753200050	32	500	45	1,8	42	20	480
5753200100	32	1000	45	1,8	42	15	300
5753200150	32	1500	45	1,8	42	15	300
5753200200	32	2000	45	1,8	42	15	300
5753200300	32	3000	45	1,8	42	15	300
5754000015	40	150	55	1,8	44	20	1440
5754000025	40	250	55	1,8	44	20	960
5754000050	40	500	55	1,8	44	20	480
5754000100	40	1000	55	1,8	44	15	420
5754000150	40	1500	55	1,8	44	15	420
5754000200	40	2000	55	1,8	44	15	420
5754000300	40	3000	55	1,8	44	15	420
5755000015	50	150	65	1,8	46	20	960
5755000025	50	250	65	1,8	46	20	540
5755000050	50	500	65	1,8	46	20	400
5755000100	50	1000	65	1,8	46	15	270
5755000150	50	1500	65	1,8	46	15	270
5755000200	50	2000	65	1,8	46	15	270
5755000300	50	3000	65	1,8	46	15	270

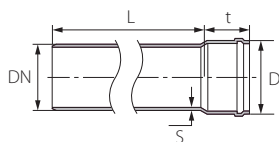
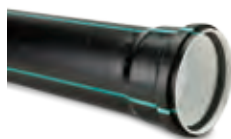

USEM jednohrdlá trubka



Kód	DN	L	D	S	t		
5757500015	75	150	90	2,3	49	20	360
5757500025	75	250	90	2,3	49	20	240
5757500050	75	500	90	2,3	49	20	160
5757500100	75	1000	90	2,3	49	10	120
5757500150	75	1500	90	2,3	49	10	120
5757500200	75	2000	90	2,3	49	10	120
5757500300	75	3000	90	2,3	49	10	120
5759000015	90	150	107	2,8	54	16	384
5759000025	90	250	107	2,8	54	20	160
5759000050	90	500	107	2,8	54	8	-
5759000100	90	1000	107	2,8	54	10	100
5759000150	90	1500	107	2,8	54	10	100
5759000200	90	2000	107	2,8	54	10	100
5759000300	90	3000	107	2,8	54	10	100
5751100015	110	150	130	3,4	65	20	180
5751100025	110	250	130	3,4	65	20	180
5751100050	110	500	130	3,4	65	10	80
5751100100	110	1000	130	3,4	65	10	80
5751100150	110	1500	130	3,4	65	10	80
5751100200	110	2000	130	3,4	65	10	80
5751100300	110	3000	130	3,4	65	10	80
5751200015	125	150	149	3,9	72	10	120
5751200025	125	250	149	3,9	72	6	108
5751200050	125	500	149	3,9	72	6	72
5751200100	125	1000	149	3,9	72	10	80
5751200150	125	1500	149	3,9	72	10	80
5751200200	125	2000	149	3,9	72	10	80
5751200300	125	3000	149	3,9	72	10	80
5751600015	160	150	186	4,9	75	8	48
5751600025	160	250	186	4,9	75	8	48
5751600050	160	500	186	4,9	75	8	32
5751600100	160	1000	186	4,9	75	6	24
5751600150	160	1500	186	4,9	75	6	24
5751600200	160	2000	186	4,9	75	6	24
5751600300	160	3000	186	4,9	75	6	24
5742000100	200	1000	228	6,2	108	1	15
5742000300	200	3000	228	6,2	108	1	15

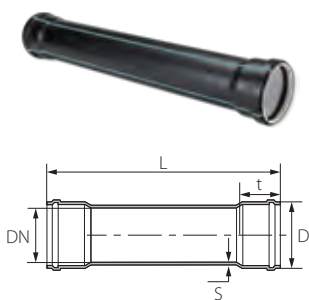

USDM dvouhrdlá trubka



Kód	DN	L	D	S	t		
5753232050	32	500	45	1,8	42	20	240
5753232100	32	1000	45	1,8	42	15	300
5753232150	32	1500	45	1,8	42	15	300
5753232200	32	2000	45	1,8	42	15	300
5753232300	32	3000	45	1,8	42	15	300
5754040050	40	500	55	1,8	44	20	240
5754040100	40	1000	55	1,8	44	15	420
5754040150	40	1500	55	1,8	44	15	420
5754040200	40	2000	55	1,8	44	15	420
5754040300	40	3000	55	1,8	44	15	420
5755050050	50	500	65	1,8	46	20	240
5755050100	50	1000	65	1,8	46	15	270
5755050150	50	1500	65	1,8	46	15	270
5755050200	50	2000	65	1,8	46	15	270
5755050300	50	3000	65	1,8	46	15	270
5757575050	75	500	90	2,2	49	20	120
5757575100	75	1000	90	2,2	49	10	120
5757575150	75	1500	90	2,2	49	10	120
5757575200	75	2000	90	2,2	49	10	120
5757575300	75	3000	90	2,2	49	10	120
5759090050	90	500	107	2,8	54	8	-
5759090100	90	1000	107	2,8	54	10	100
5759090150	90	1500	107	2,8	54	10	100
5759090200	90	2000	107	2,8	54	10	100
5759090300	90	3000	107	2,8	54	10	100
5751111050	110	500	130	3,4	65	10	60
5751111100	110	1000	130	3,4	65	10	80
5751111150	110	1500	130	3,4	65	10	80
5751111200	110	2000	130	3,4	65	10	80
5751111300	110	3000	130	3,4	65	10	80
5751212050	125	500	149	3,9	72	6	60
5751212100	125	1000	149	3,9	72	10	80
5751212150	125	1500	149	3,9	72	10	80
5751212200	125	2000	149	3,9	72	10	80
5751212300	125	3000	149	3,9	72	10	80

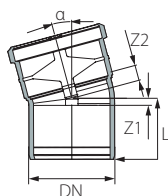

USB koleno 15°



Kód	DN	L	Z1	Z2		
7070000170	32	44,5	4,0	9,0	40	4800
7070010170	40	51,5	4,0	10,0	40	2400
7070020170	50	56,5	5,0	11,0	40	1200
7070030170	75	63,5	7,0	14,0	20	600
7070090170	90	68,0	8,0	16,0	20	480
7070040170	110	78,0	6,0	19,0	20	240
7070050170	125	87,0	12,0	21,9	10	160
7070060170	160	99,0	8,0	22,0	5	80

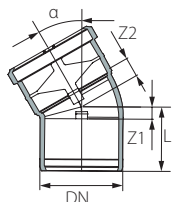

USB koleno 30°



Kód	DN	L	Z1	Z2		
7070000370	32	47,5	5,0	10,0	40	4800
7070010370	40	54,5	7,0	13,0	40	2400
7070020370	50	59,5	8,0	14,0	40	1200
7070030370	75	68,5	12,0	18,0	20	600
7070090370	90	74,0	14,0	20,5	20	320
7070040370	110	85,0	16,0	25,5	20	240
7070050370	125	104	29,0	30,0	10	160
7070060370	160	105,0	27,0	29,0	5	80

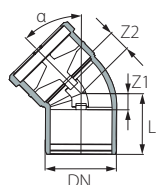

USB koleno 45°



Kód	DN	L	Z1	Z2		
7070000470	32	53,0	8,0	13,0	40	4800
7070010470	40	58,5	11,0	17,0	40	2400
7070020470	50	64,0	13,0	19,0	40	1200
7070030470	75	74,5	18,0	24,0	20	600
7070090470	90	81,0	21,0	27,5	20	320
7070040470	110	94,0	25,0	33,5	20	240
7070050470	125	104,0	29,0	38,0	10	160
7070060470	160	116,0	36,0	44,0	5	60
7070080470	200	148,0	49,0	63,0	3	36

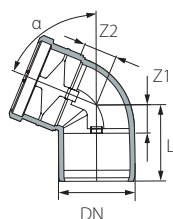

USB koleno 67.5°



Kód	DN	L	Z1	Z2		
7070000670	32	58,0	13,0	18,0	40	2400
7070010670	40	65,5	18,0	24,0	40	1600
7070020670	50	72,5	21,0	27,0	40	1200
7070030670	75	85,5	29,0	35,0	20	480
7070090670	90	94,0	34,0	40,0	20	320
7070040670	110	110,0	44,0	48,0	20	240
7070050670	125	118,0	48,0	52,0	10	160

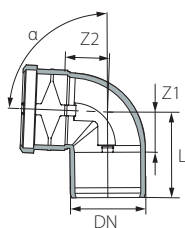

USB koleno 87.5°



Kód	DN	L	Z1	Z2		
7070000870	32	64,0	20,0	24,0	40	2400
7070010870	40	73,5	26,0	32,0	40	1600
7070020870	50	79,5	28,5	35,0	40	1200
7070030870	75	99,5	43,0	49,0	20	480
7070090870	90	110,0	50,0	56,0	20	320
7070040870	110	129,0	60,0	66,0	20	240
7070050870	125	142,0	67,0	73,0	10	160
7070060870	160	162,0	79,5	81,0	5	60

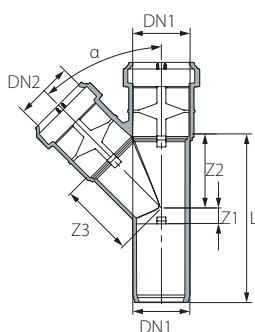

USEA odbočka 45°



Kód	DN1	DN2	Z1	Z2	Z3	L		
7070600470	32	32	9,0	42,0	42,0	95,0	20	1200
7070611470	40	40	11,0	52,0	52,0	111,0	20	800
7070621470	50	40	13,0	64,0	57,0	129,0	20	600
7070622470	50	50	13,0	64,0	64,0	129,0	20	600
7070632470	75	50	18,0	95,0	100,0	170,0	20	320
7070633470	75	75	18,0	95,0	95,0	170,0	20	320
7070691470	90	40	32,5	112,5	92,0	205,0	10	120
7070692470	90	50	32,5	112,5	89,0	205,0	10	120
7070699470	90	90	33,0	113,0	112,5	206,0	10	160
7070641470	110	40	25,0	137,0	107,0	231,0	10	120
7070642470	110	50	25,0	137,0	103,0	231,0	10	120
7070643470	110	75	25,0	137,0	116,0	231,0	10	120
7070649470	110	90	25,0	137,0	143,0	231,0	10	120
7070644470	110	110	25,0	137,0	137,0	231,0	8	96
7070654470	125	110	18,0	145,0	149,0	238,0	8	96
7070655470	125	125	31,0	152,0	152,0	258,0	6	72
7070664470	160	110	39,0	159,0	169,0	284,0	5	60
7070666470	160	160	39,0	194,0	194,0	319,0	3	36
7070686470	200	160	19,0	213,0	224,0	334,0	2	16
7070688470	200	200	25,0	219,0	226,0	343,0	-	-

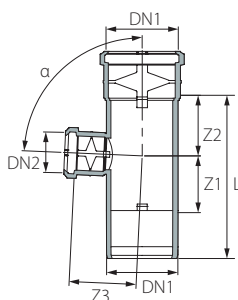

USEA odbočka 87.5°



Kód	DN1	DN2	Z1	Z2	Z3	L		
7070600870	32	32	90,0	42,0	42,0	0,65	20	1600
7070611870	40	40	13,0	64,0	64,0	64,5	20	600
7070621870	50	40	32,3	31,0	62,0	112,5	20	600
7070622870	50	50	31,0	30,0	62,0	112,5	20	600
7070632870	75	50	58,0	55,0	60,0	170,0	20	320
7070633870	75	75	58,0	55,0	55,0	114,5	20	320
7070692870	90	50	69,0	76,0	83,0	205,0	10	120
7070642870	110	50	77,0	85,0	93,0	231,0	10	120
7070655870	125	125	78,0	73,0	72,0	225,0	6	72
7070666870	160	160	19,0	213,0	224,0	334,0	4	48

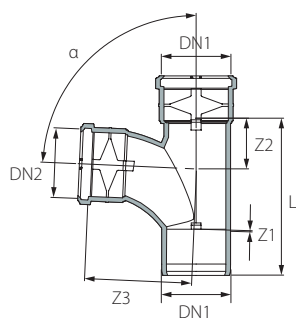

USIA pozvolná odbočka 87.5°



Kód	DN1	DN2	Z1	Z2	Z3	L		
7070799870	90	90	79,0	66,0	97,0	205,0	10	160
7070743870	110	75	82,0	60,0	97,0	211	10	120
7070749870	110	90	82,0	60,0	97,0	211,0	10	120
7070744870	110	110	82,0	60,0	97,0	211,0	10	120
7070754870	125	110	100,0	65,0	117,0	240	6	72
7070764870	160	110	96,0	84,0	117,0	266	4	48

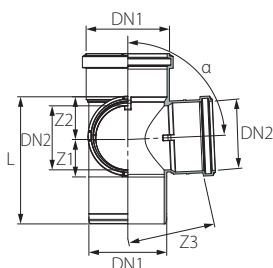

USED rohová odbočka 87.5°



Kód	DN1	DN2	Z1	Z2	Z3	L		
7071244870	110	110	62,0	70,0	69,0	198,0	6	72
7071254870	125	110	62,0	64,0	69,0	202,0	5	60

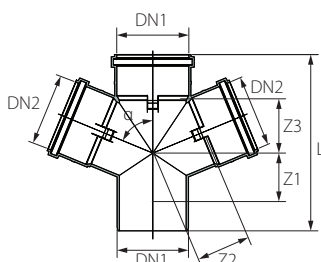

USDA dvojitá odbočka 67.5°



Kód	DN1	DN2	Z1	Z2	Z3	L		
7071042670	110	50	17,0	73,0	54,0	207,0	8	128
7071044670	110	110	51,0	85,0	85,0	272,0	6	72

USDA dvojitá odbočka 87.5°



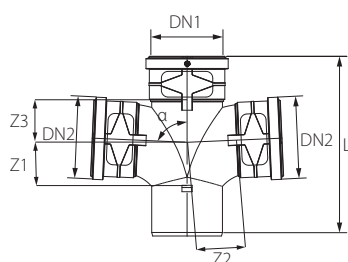

Kód	DN1	DN2	Z1	Z2	Z3	L		
7071044870	110	110	77,0	80,94	66,94	211,0	6	72



USRE čistící kus



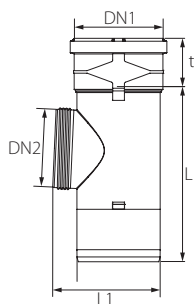

Kód	DN1	DN2	t	L	L1		
7079120070	50	45	55,0	140,0	65,0	20	800
7079130070	75	45	71,0	140,0	98,0	20	320
7079190070	90	45	60,5	202,0	118,0	10	180
7079140070	110	97	64,0	231,0	142,0	10	120
7079150070	125	97	73,0	222,0	158,0	8	96
7079160070	160	97	84,0	236,0	192,0	6	72
7079180070	200	97	93,0	343,0	231,0	2	24



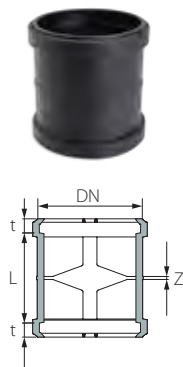

USMM spojka dvouhrdlá



Kód	DN	t	L	Z		
7071700270	32	14,0	64,0	2,0	-	-
7071710270	40	14,0	60,0	2,0	30	1800
7071720270	50	14,0	68,0	2,0	20	1200
7071730270	75	14,0	77,0	2,3	20	800
7071790270	90	14,0	85,0	1,4	20	480
7071740270	110	17,0	97,0	3,3	20	320
7071750270	125	16,8	118,6	4,1	10	160
7071760270	160	17,0	131,0	4,5	10	120
7071780270	200	29,0	196,0	6,0	-	-



USU nátrubek



Kód	DN	t	L		
7071710070	40	14,0	60,0	30	1800
7071720070	50	14,0	68,0	20	1200
7071730070	75	14,0	77,0	20	800
7071790070	90	14,0	85,0	20	480
7071740070	110	17,0	97,0	20	320
7071750070	125	16,8	118,6	10	160
7071760070	160	17,0	131,0	10	120
7071780070	200	29,0	196,0	-	-

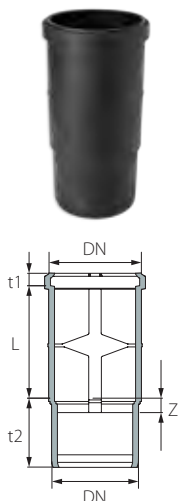

USLL prodloužené hrdlo



Kód	DN	t1	t2	L	Z		
7072210070	40	13,1	107,0	66,0	13,0	-	-
7072220070	50	13,1	99,0	61,0	7,0	20	1200
7072230070	75	13,1	113,0	69,0	10,0	20	360
7072290070	90	13,1	131,0	76,0	13,0	20	320
7072240070	110	16,0	141,0	87,0	14,0	15	180
7072250070	125	19,1	189,0	91,0	16,0	10	120
7072260070	160	23,1	107,0	160,0	20,5	6	72

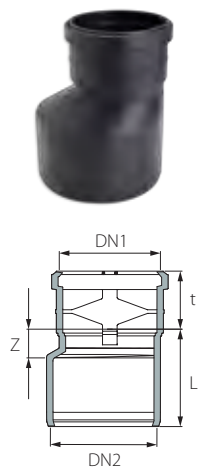

USR redukce



Kód	DN1	DN2	L	t	Z		
7072110070	32	40	48,0	42,0	14,0	30	3600
7072120070	32	50	65,0	42,0	15,0	30	3600
7072121070	40	50	64,0	42,0	15,0	30	1800
7072191070	40	90	93,0	47,0	35,0	20	800
7072141070	40	110	122,5	43,0	51,0	20	480
7072132070	50	75	85,0	47,0	26,0	20	1200
7072192070	50	90	97,0	47,0	34,0	20	800
7072193070	50	110	118,0	47,0	46,0	20	480
7072142070	75	90	86,0	51,5	24,0	20	600
7072143070	75	110	106,0	52,0	34,0	20	360
7072149070	90	110	101,0	55,0	29,0	20	360
7072154070	110	125	106,0	64,0	29,0	10	240
7072164070	110	160	137,0	64,0	84,0	10	160
7072165070	125	160	140,0	55,0	74,0	10	80
7072186070	160	200	153,0	80,0	54,0	6	96

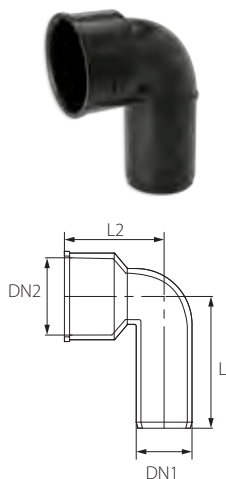

USSW sifonové koleno



Kód	DN1	DN2	L1	L2		
7074010970	32	46	76,0	58,0	20	2400
7074021970	40	50	82,0	56,0	20	1200
7074011970	40	46	76,0	56,0	20	1200
7074022970	50	50	82,0	60,0	20	1200

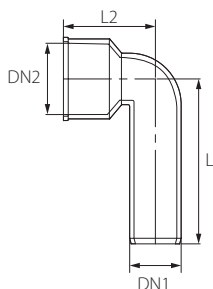

USSWL prodloužené sifonové koleno



Kód	DN1	DN2	L1	L2		
7074021971	40	50	140,0	56,0	20	1200
7074011971	40	46	140,0	57,0	20	1200

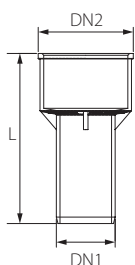

USS přímé sifonové dopojení



Kód	DN1	DN2	L		
7141760070	32	46	63,0	20	2400
7141721070	40	46	63,0	20	2400
7141761070	40	50	63,0	20	2400
7141722070	50	50	63,0	20	2400



Gumové těsnění pro US, USSW, USSWL



Kód	DN	DN2		
T047T000000000	26/32	46	500	-
T046T000000000	40	46	1000	-
T050T000000032	26/32	50	500	-
T050T000000040	40	50	500	-

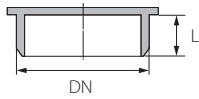

USM zátka

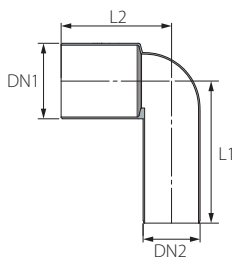

Kód	DN	L		
7071610070	40	40,0	40	4800
7071620070	50	44,0	30	3600
7071630070	75	51,0	20	2400
7071690070	90	60,0	20	1200
7071640070	110	62,0	20	800
7071650070	125	75,0	20	480
7071660070	160	86,0	20	320

USSBL dlouhé WC koleno





Kód	DN1	DN2	L1	L2		
7195000070	119,6	90,0	175,0	225,0	10	120
7155000070	119,6	110,0	185,0	226,0	10	120

Příslušenství

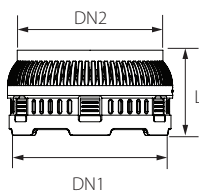

Pojistka hrdlového spoje proti vysunutí



Kód	DN	DN1	DN2	L		
7072330000	75	91,5	79,8	81,0	40	960
7072340000	110	129,5	112,0	72,6	30	480
7072350000	125	149,0	126,6	94,0	16	288
7072360000	160	186,5	162,0	99,7	10	160

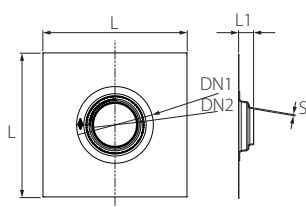

Hydroizolační membrána









Kód	DN	DN1	DN2	L	S	L1		
7981100000	110	220	102	340	3	52	30	480
7981250000	125	239	121	500	3	52	20	320
7981600000	160	266	149	500	3	52	20	320

US mazadlo









Kód	ml		
47700012	250	50	-
47700013	1000	12	1728

Rejstřík

Kód	Strana			Kód	Strana			Kód	Strana		
47700012	20	50	-	5753232200	10	15	300	5759090050	10	8	-
47700013	20	12	1728	5753232300	10	15	300	5759090100	10	10	100
5742000100	9	1	15	5754000015	8	20	1440	5759090150	10	10	100
5742000300	9	1	15	5754000025	8	20	960	5759090200	10	10	100
5751100015	9	20	180	5754000050	8	20	480	5759090300	10	10	100
5751100025	9	20	180	5754000100	8	15	420	7070000170	11	40	4800
5751100050	9	10	80	5754000150	8	15	420	7070000370	11	40	4800
5751100100	9	10	80	5754000200	8	15	420	7070000470	11	40	4800
5751100150	9	10	80	5754000300	8	15	420	7070000670	12	40	2400
5751100200	9	10	80	5754040050	10	20	240	7070000870	12	40	2400
5751100300	9	10	80	5754040100	10	15	420	7070010170	11	40	2400
5751111050	10	10	60	5754040150	10	15	420	7070010370	11	40	2400
5751111100	10	10	80	5754040200	10	15	420	7070010470	11	40	2400
5751111150	10	10	80	5754040300	10	15	420	7070010670	12	40	1600
5751111200	10	10	80	5755000015	8	20	960	7070010870	12	40	1600
5751111300	10	10	80	5755000025	8	20	540	7070020170	11	40	1200
5751200015	9	10	120	5755000050	8	20	400	7070020370	11	40	1200
5751200025	9	6	108	5755000100	8	15	270	7070020470	11	40	1200
5751200050	9	6	72	5755000150	8	15	270	7070020670	12	40	1200
5751200100	9	10	80	5755000200	8	15	270	7070020870	12	40	1200
5751200150	9	10	80	5755000300	8	15	270	7070030170	11	20	600
5751200200	9	10	80	5755050050	10	20	240	7070030370	11	20	600
5751200300	9	10	80	5755050100	10	15	270	7070030470	11	20	600
5751212050	10	6	60	5755050150	10	15	270	7070030670	12	20	480
5751212100	10	10	80	5755050200	10	15	270	7070030870	12	20	480
5751212150	10	10	80	5755050300	10	15	270	7070040170	11	20	240
5751212200	10	10	80	5757500015	9	20	360	7070040370	11	20	240
5751212300	10	10	80	5757500025	9	20	240	7070040470	11	20	240
5751600015	9	8	48	5757500050	9	20	160	7070040670	12	20	240
5751600025	9	8	48	5757500100	9	10	120	7070040870	12	20	240
5751600050	9	8	32	5757500150	9	10	120	7070050170	11	10	160
5751600100	9	6	24	5757500200	9	10	120	7070050370	11	10	160
5751600150	9	6	24	5757500300	9	10	120	7070050470	11	10	160
5751600200	9	6	24	5757575050	10	20	120	7070050670	12	10	160
5751600300	9	6	24	5757575100	10	10	120	7070050870	12	10	160
5753200015	8	20	1140	5757575150	10	10	120	7070060170	11	5	80
5753200025	8	20	960	5757575200	10	10	120	7070060370	11	5	80
5753200050	8	20	480	5757575300	10	10	120	7070060470	11	5	60
5753200100	8	15	300	5759000015	9	16	384	7070060870	12	5	60
5753200150	8	15	300	5759000025	9	20	160	7070080470	11	3	36
5753200200	8	15	300	5759000050	9	8	-	7070090170	11	20	480
5753200300	8	15	300	5759000100	9	10	100	7070090370	11	20	320
5753232050	10	20	240	5759000150	9	10	100	7070090470	11	20	320
5753232100	10	15	300	5759000200	9	10	100	7070090670	12	20	320
5753232150	10	15	300	5759000300	9	10	100	7070090870	12	20	320

Rejstřík

Kód	Strana			Kód	Strana			Kód	Strana		
7070600470	13	20	1200	7071650070	19	20	480	7072360000	20	10	160
7070600870	13	20	1600	7071660070	19	20	320	7074010970	17	20	2400
7070611470	13	20	800	7071690070	19	20	1200	7074011970	17	20	1200
7070611870	13	20	600	7071700270	16	-	-	7074011971	18	20	1200
7070621470	13	20	600	7071710070	16	30	1800	7074021970	17	20	1200
7070621870	13	20	600	7071710270	16	30	1800	7074021971	18	20	1200
7070622470	13	20	600	7071720070	16	20	1200	7074022970	17	20	1200
7070622870	13	20	600	7071720270	16	20	1200	7079120070	15	20	800
7070632470	13	20	320	7071730070	16	20	800	7079130070	15	20	320
7070632870	13	20	320	7071730270	16	20	800	7079140070	15	10	120
7070633470	13	20	320	7071740070	16	20	320	7079150070	15	8	96
7070633870	13	20	320	7071740270	16	20	320	7079160070	15	6	72
7070641470	13	10	120	7071750070	16	10	160	7079180070	15	2	24
7070642470	13	10	120	7071750270	16	10	160	7079190070	15	10	180
7070642870	13	10	120	7071760070	16	10	120	7141721070	18	20	2400
7070643470	13	10	120	7071760270	16	10	120	7141722070	18	20	2400
7070644470	13	8	96	7071780070	16	-	-	7141760070	18	20	2400
7070649470	13	10	120	7071780270	16	-	-	7141761070	18	20	2400
7070654470	13	8	96	7071790070	16	20	480	7155000070	19	10	120
7070655470	13	6	72	7071790270	16	20	480	7195000070	19	10	120
7070655870	13	6	72	7072110070	17	30	3600	7981100000	20	5	30
7070664470	13	5	60	7072120070	17	30	3600	7981250000	20	5	20
7070666470	13	3	36	7072121070	17	30	1800	7981600000	20	5	20
7070666870	13	4	48	7072132070	17	20	1200	T046T000000000	18	1000	-
7070686470	13	2	16	7072141070	17	20	480	T047T000000000	18	500	-
7070688470	13	-	-	7072142070	17	20	600	T050T0000000032	18	500	-
7070691470	13	10	120	7072143070	17	20	360	T050T0000000040	18	500	-
7070692470	13	10	120	7072149070	17	20	360				
7070692870	13	10	120	7072154070	17	10	240				
7070699470	13	10	160	7072164070	17	10	160				
7070743870	14	10	120	7072165070	17	10	80				
7070744870	14	10	120	7072186070	17	6	96				
7070749870	14	10	120	7072191070	17	20	800				
7070754870	14	6	72	7072192070	17	20	800				
7070764870	14	4	48	7072193070	17	20	480				
7070799870	14	10	160	7072210070	16	-	-				
7071042670	14	8	128	7072220070	16	20	1200				
7071044670	14	6	72	7072230070	16	20	360				
7071044870	15	6	72	7072240070	16	15	180				
7071244870	14	6	72	7072250070	16	10	120				
7071254870	14	5	60	7072260070	16	6	72				
7071610070	19	40	4800	7072290070	16	20	320				
7071620070	19	30	3600	7072330000	20	40	960				
7071630070	19	20	2400	7072340000	20	30	480				
7071640070	19	20	800	7072350000	20	16	288				





MAXMARK Ultra Silent / REV.001 / 03.2017

LEVEL
HOUSE



ADVANCED FLOW
SYSTEMS™

www.huliot.com

HULIOT A.C.S. Ltd. Kibbutz Sde-Nechemia, Upper Galilee 1214500, Israel
Tel: +972-4-6946011, Fax: +972-4-6951444 | info@huliot.com

HULIOT D.O.O., Vrhniška cesta 30, SI-1354 Horjul, Slovenia

HOUSE LEVEL s.r.o., Kolaříkova 1, 621 00 Brno Česká Republika
Tel: +420 541 213 651, email: houselevel@houselevel.cz, www.houselevel.cz