

# DORSI 2K

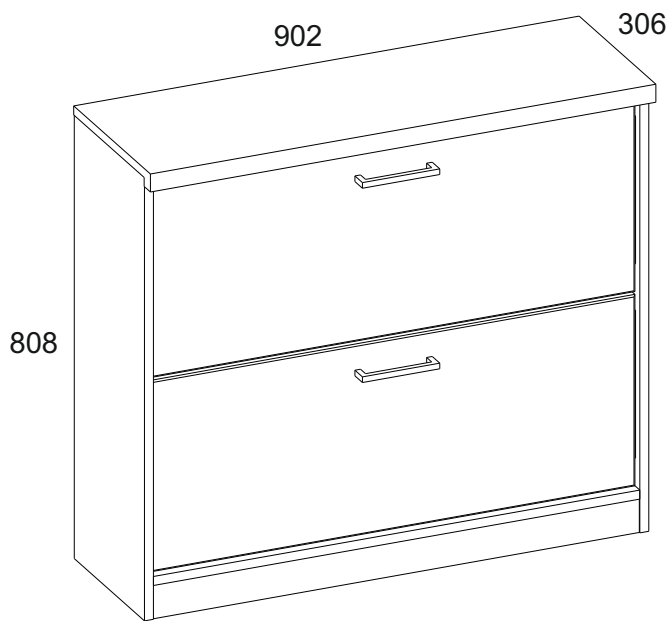

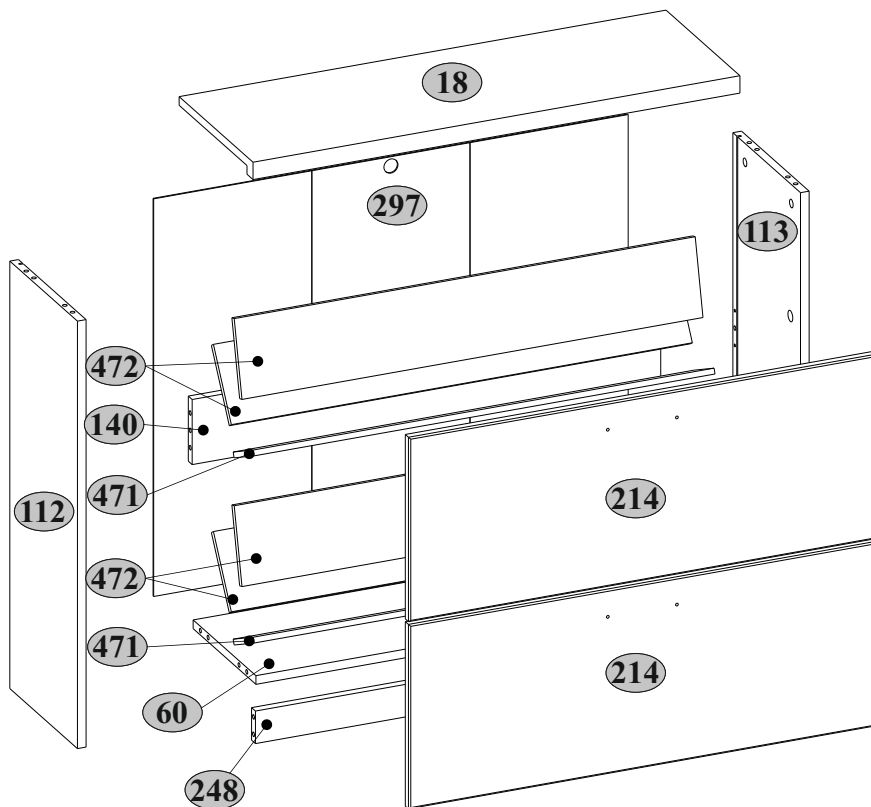











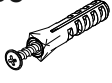
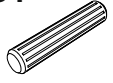



---

---



	L, mm	B, mm	H, mm	Q	
18	902	306	32	1	2/2
60	868	260	16	1	2/2
112	788	280	16	1	2/2
113	788	280	16	1	2/2
140	868	120	16	1	2/2
214	864	340	16	2	1/2
248	868	60	16	1	2/2
297	733	879	2,5	1	2/2
471	854	90	10	2	1/2
472	854	140	10	4	1/2

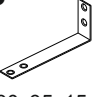

<b>A1</b>  7x34 12	<b>A2</b>  Ø15x12 12	<b>B5</b>  10x50 1	<b>C1</b>  8x35 14
<b>J1</b>  2	<b>J2</b>  4	<b>J3</b>  4	<b>J4</b>  4
<b>H58</b>  2	<b>N1</b>  4	<b>R1</b>  3x13 12	<b>R3</b>  3x20 6
<b>R19</b>  6,0x13 4	<b>R32</b>  4x27 4	<b>R102</b>  3,5x16 17	<b>S1</b>  8
	<b>S5</b>  Ø18 4	<b>U</b>  130x35x15 1	

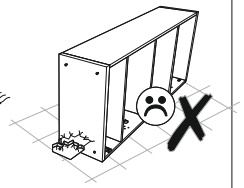
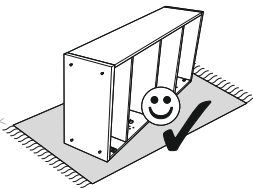
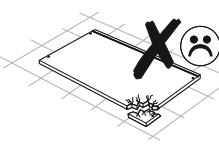
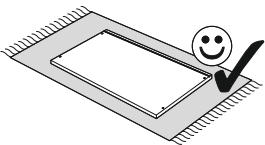
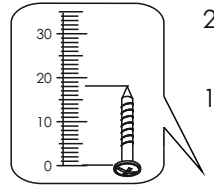
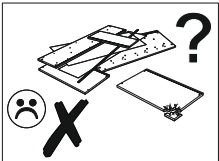
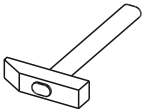
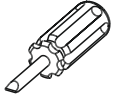
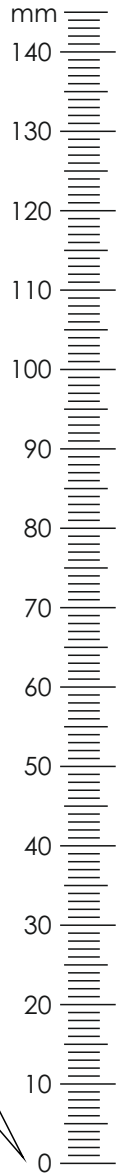

**1****A1**

7x34

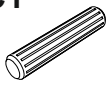
**C1**

8 8x35

**J2**

4

**J4**

4

**N1**

4

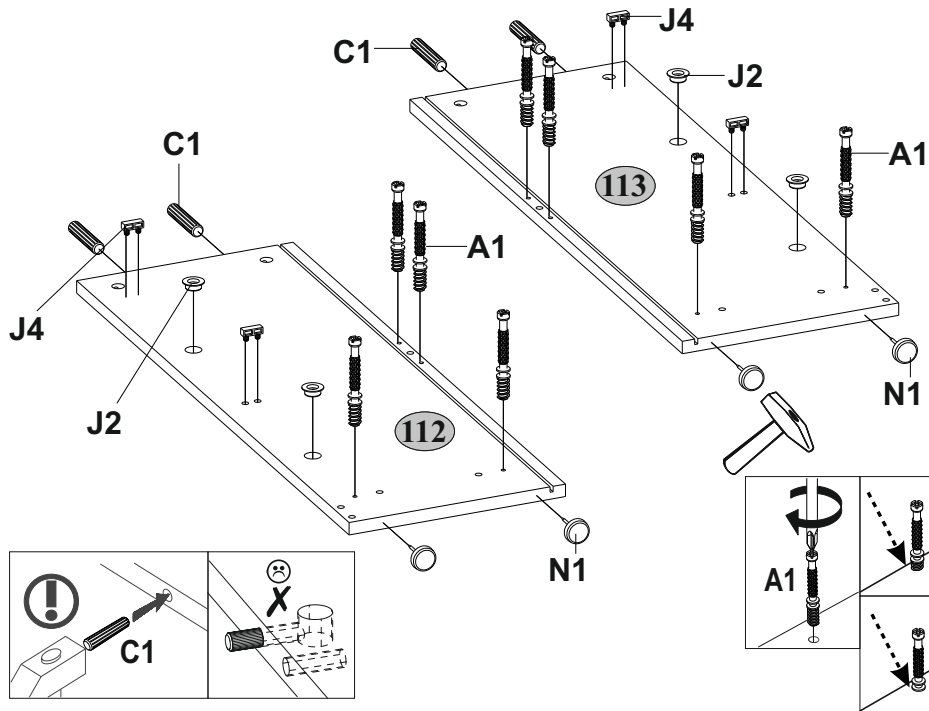
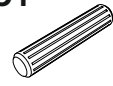
**2****C1**

8x35

10

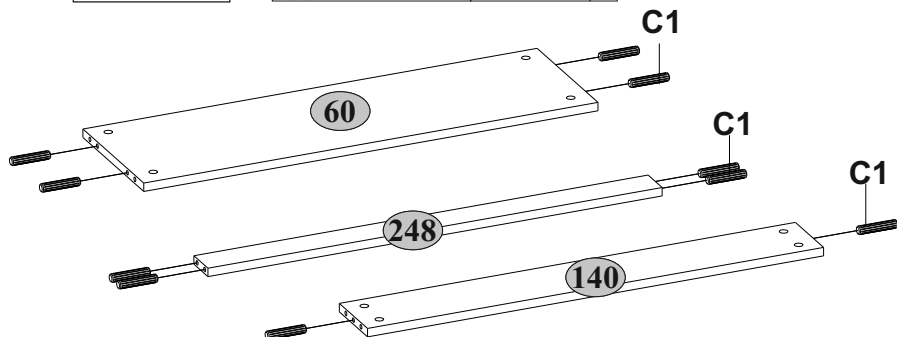
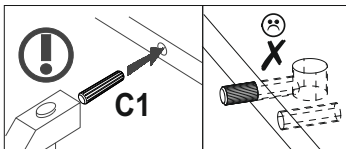

3

A2



Ø15x12

8

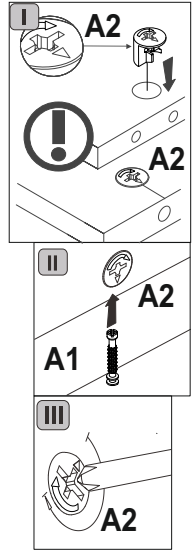
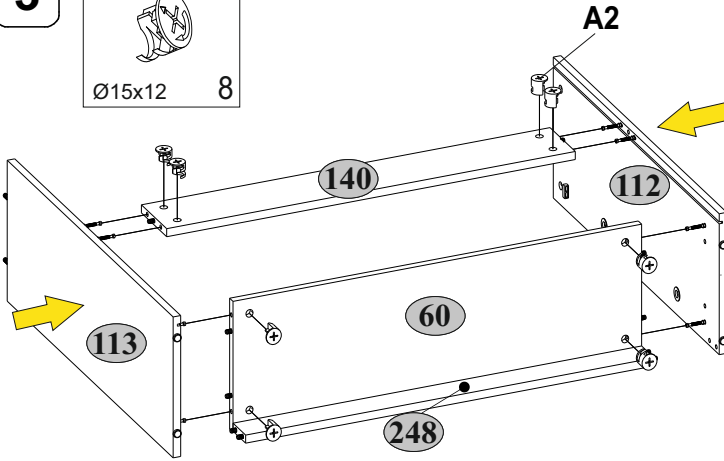

4

A1



7x34

4

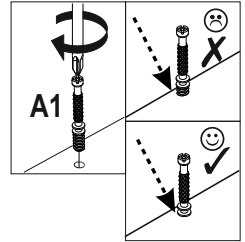
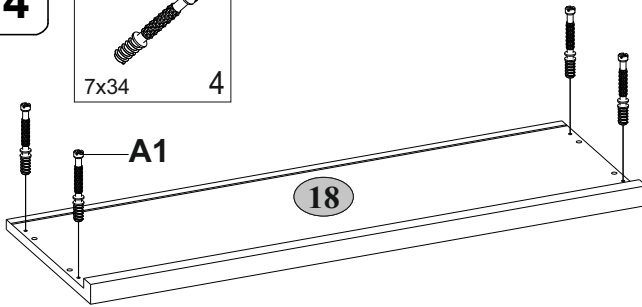

5

A2



Ø15x12

4

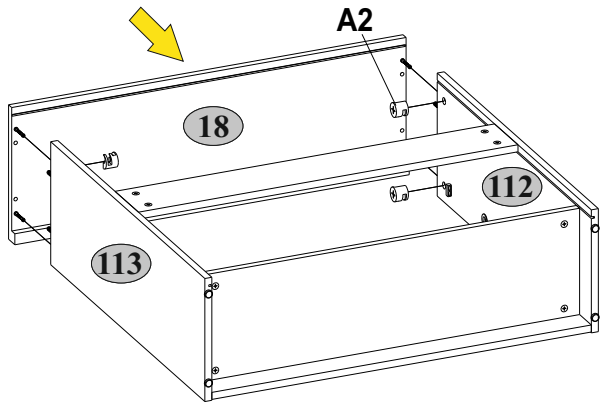

6

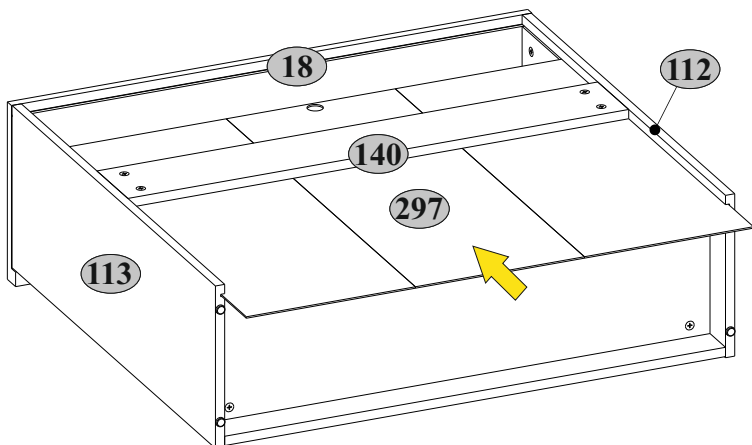



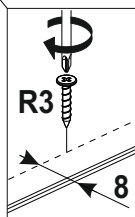
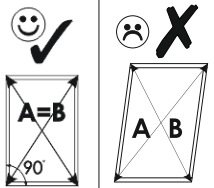
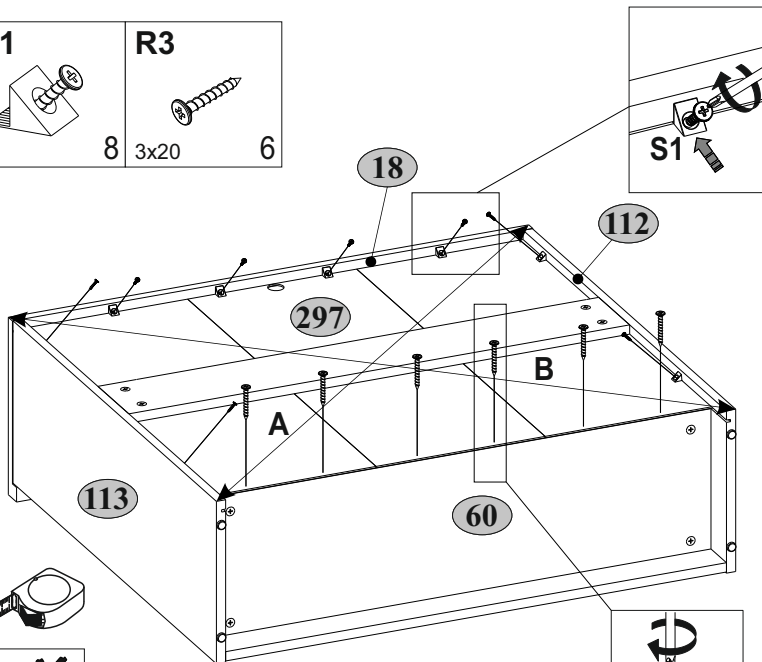
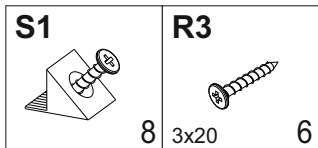

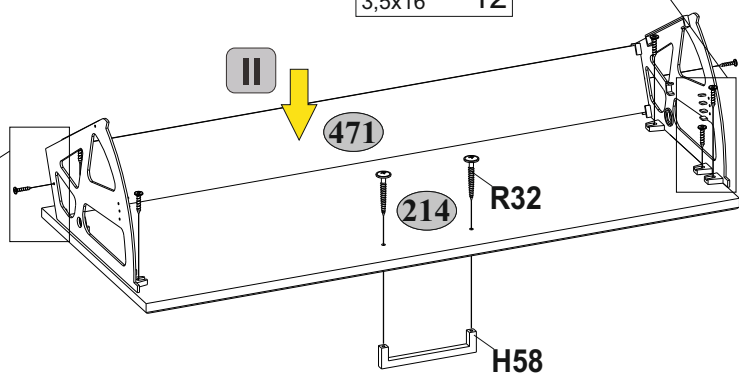
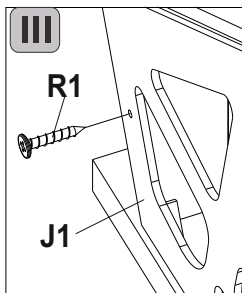
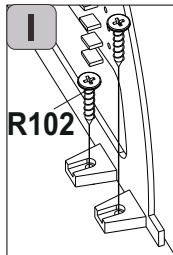
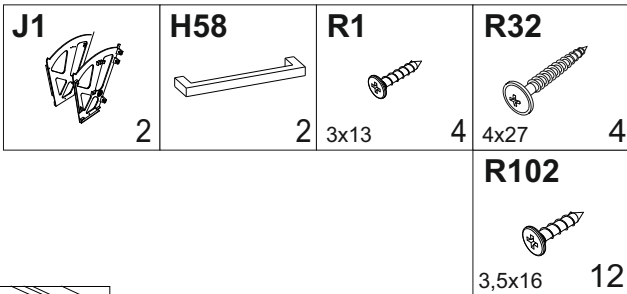
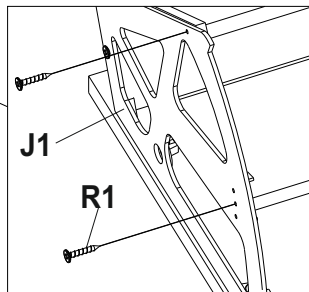
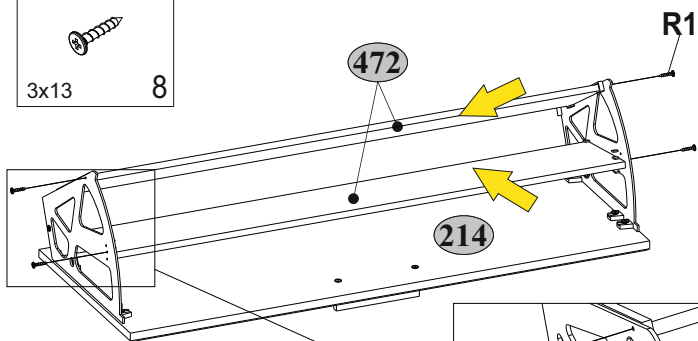
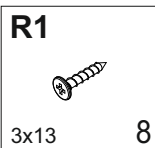
7



**8****x2****9****x2**

10

<b>B5</b>  10x50	<b>R102</b>  3,5x16	<b>S5</b>  5 Ø18	<b>U</b>  4 130x35x15
---	--	---	--

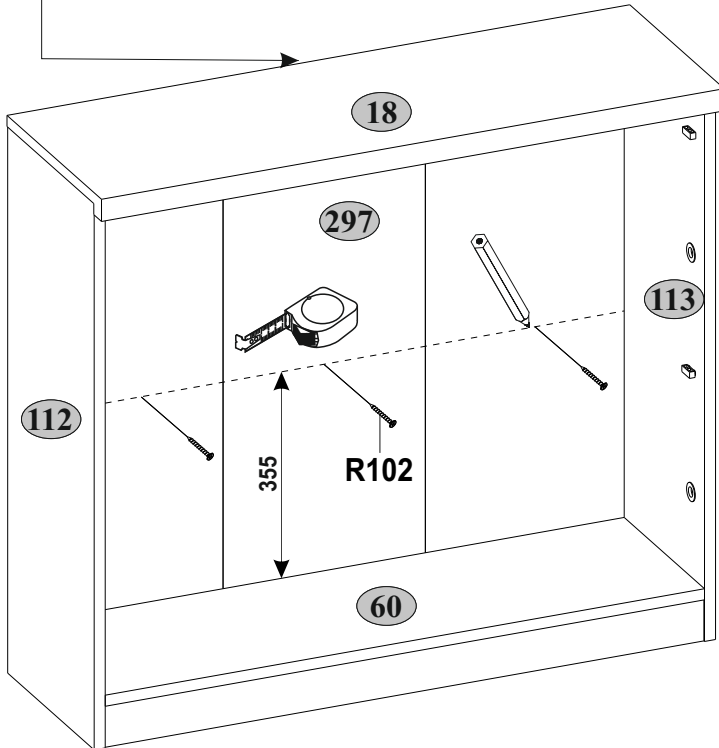
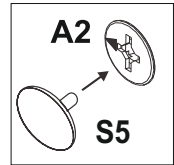
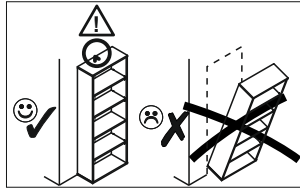
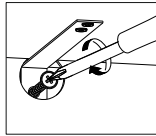
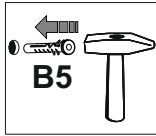
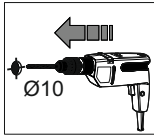
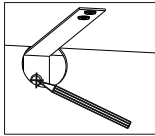
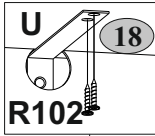



11

J3



R19



4 6,0x13

4

214



max.  
3 kg

18



max.  
10 kg

