

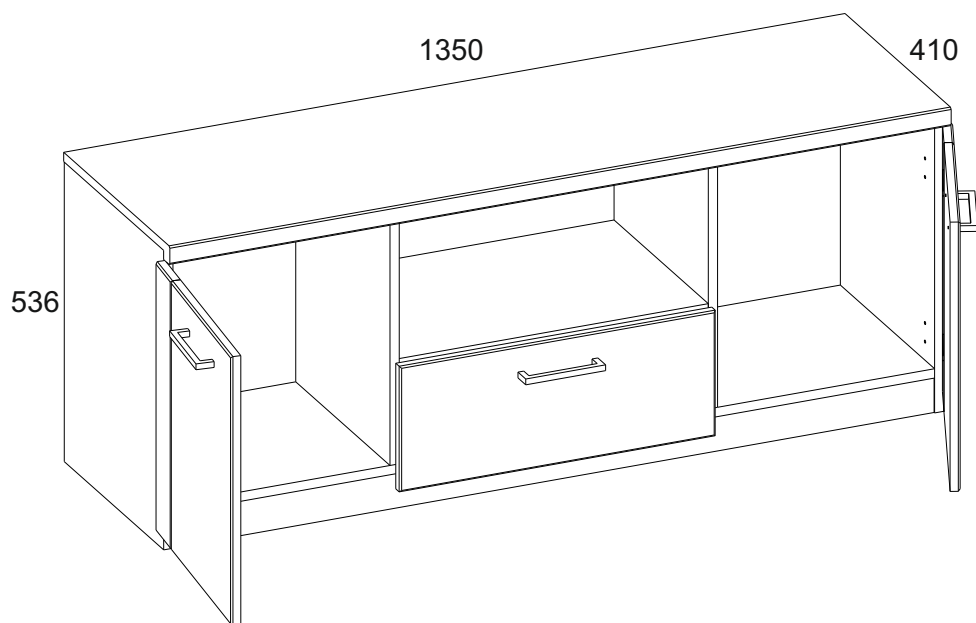

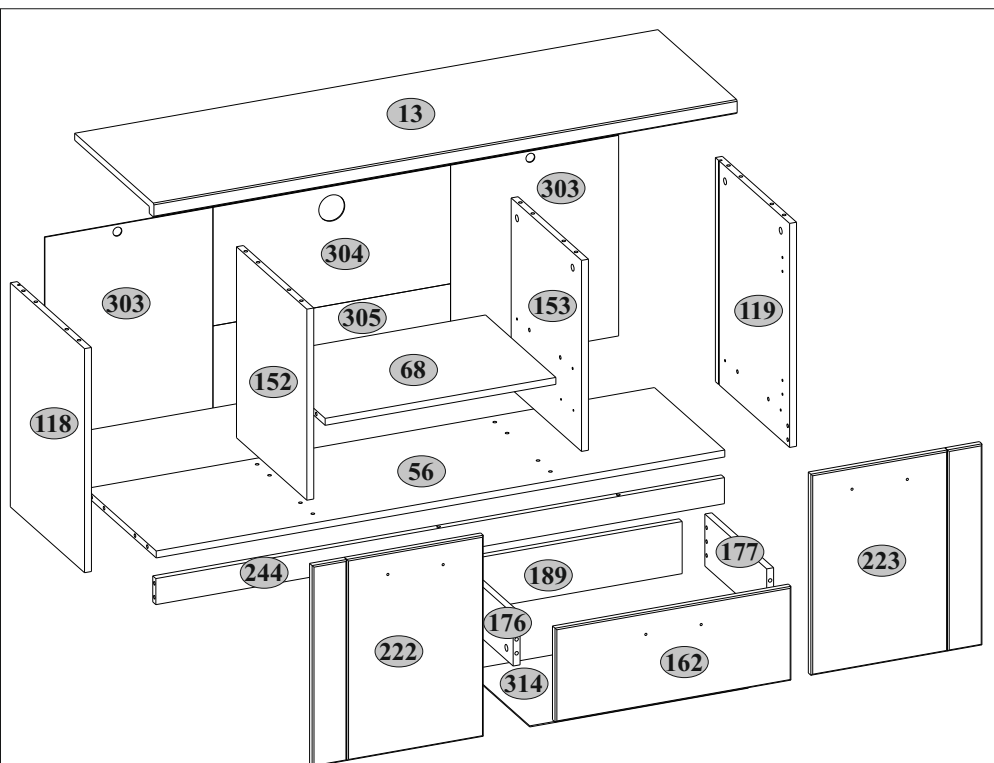









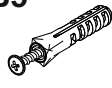
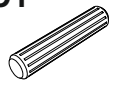
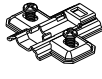
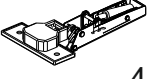

DORSI RTV 2D1S/135





	L, mm	B, mm	H, mm	Q	
13	1350	410	32	1	2/2
56	1316	364	16	1	2/2
68	534	364	16	1	1/2
118	516	384	16	1	2/2
119	516	384	16	1	2/2
152	440	364	16	1	1/2
153	440	364	16	1	1/2
162	546	216	16	1	1/2
176	320	120	16	1	2/2
177	320	120	16	1	2/2
189	476	120	16	1	1/2
222	463	396	16	1	1/2
223	463	396	16	1	1/2
244	1316	60	16	1	2/2
303	462	389	2,5	2	1/2
304	273	550	2,5	1	2/2
305	189	550	2,5	1	2/2
314	506	325	2,5	1	1/2

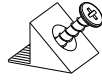
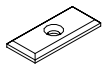

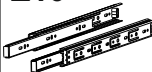
A1  7x34 20	A2  Ø15x12 20	B5  10x50 2	C1  8x35 31
D1-1  4	E1-1  4	I  S4 1	H58  3
N1  6	R3  3x20 24	R23  6,3x13 8	R24  7x50 8
R27  5,0x13 10	R32  4x27 6	R102  3,5x16 12	S1  10
S3  8	S5  Ø18 12	U  130x35x15 2	Z10  300 1

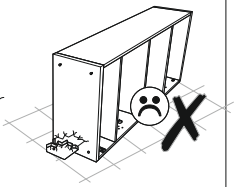
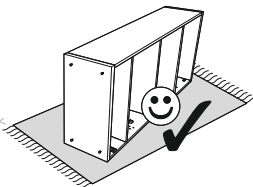
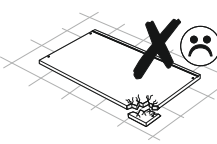
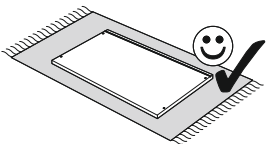
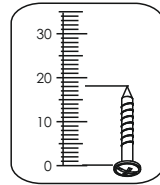
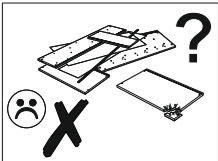
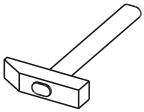
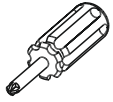
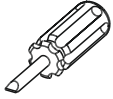
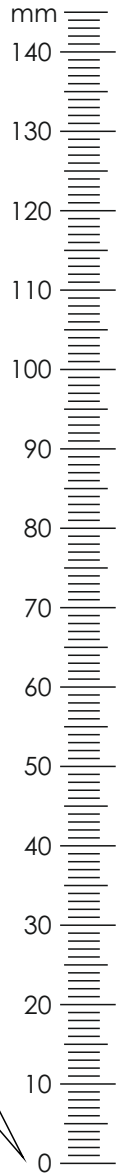

1

A1



7x34

C1

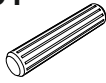

4 8x35

R27



8 5,0x13

Z10

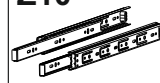

6 300 1

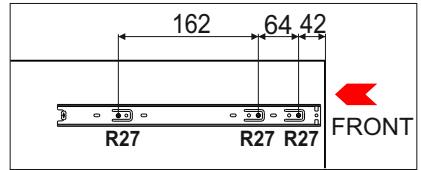
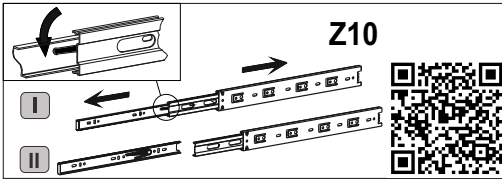
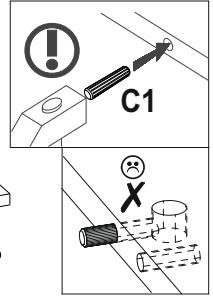
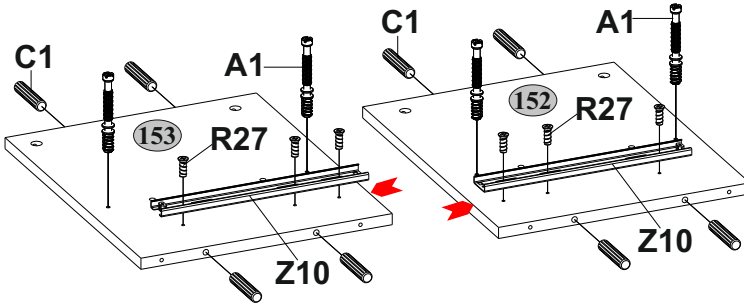

2

C1

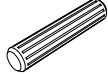

8x35 15

N1



2

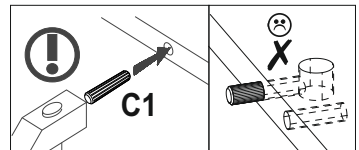
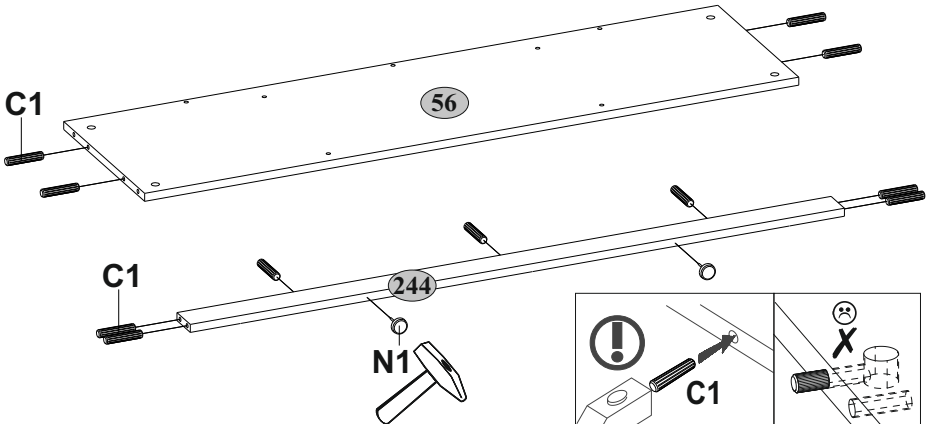
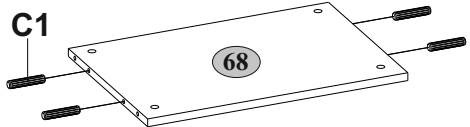

5

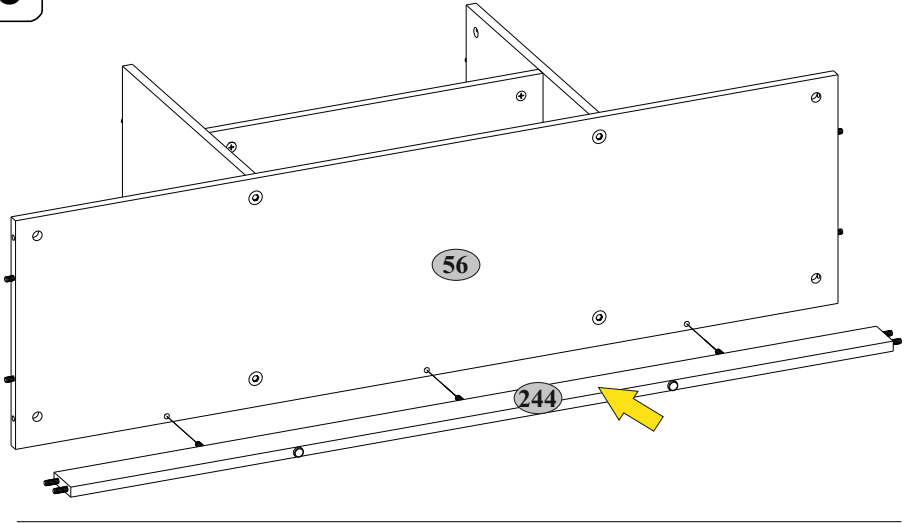

6

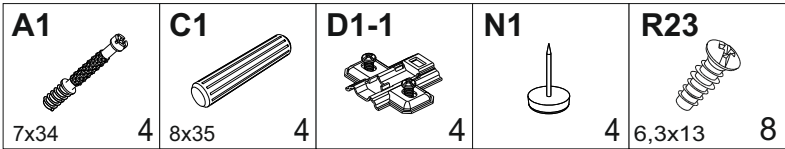

E1-1+D1-1

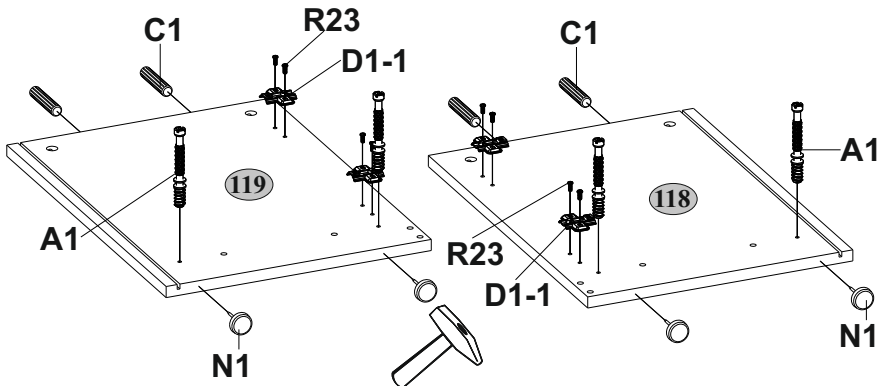
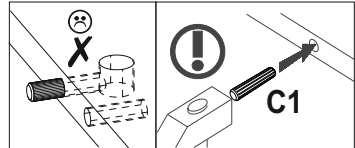
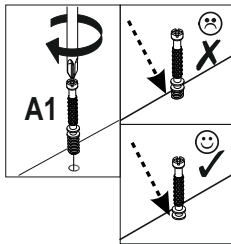
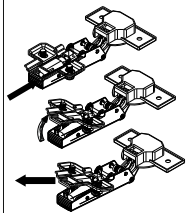

3

A2

Ø15x12

4

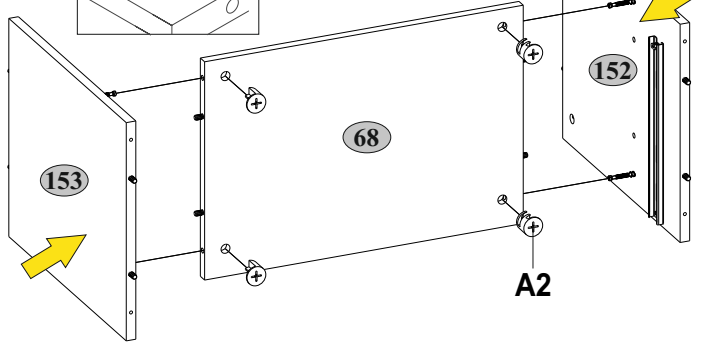
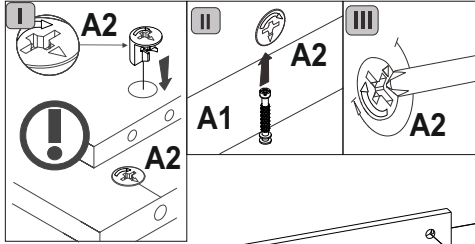

4

I



S4

R24

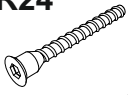

1

7x50

4

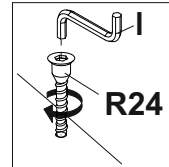

R24

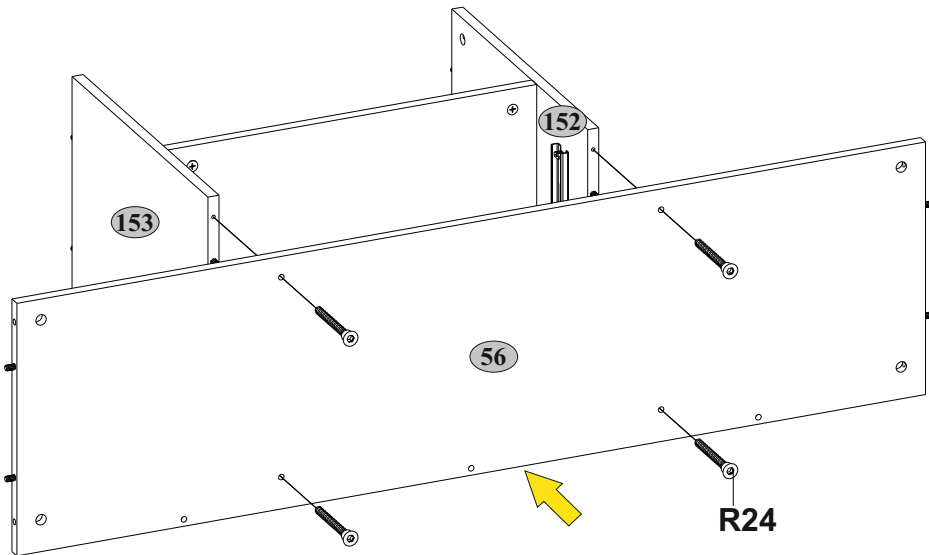

7

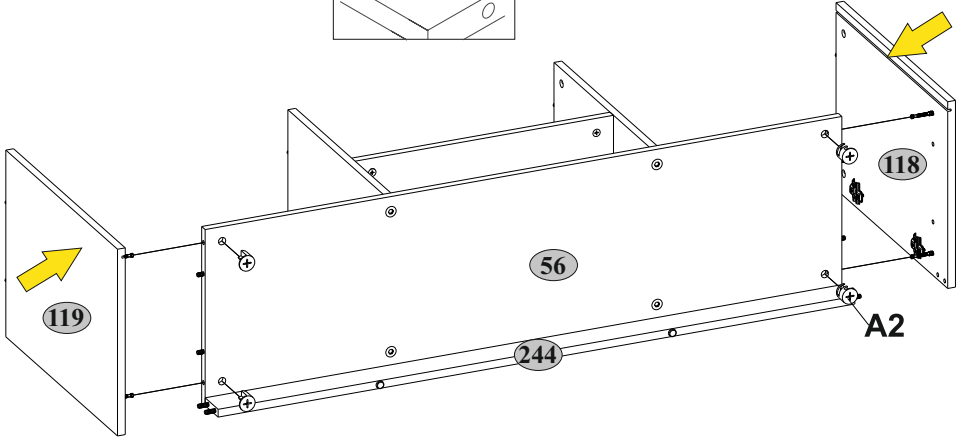
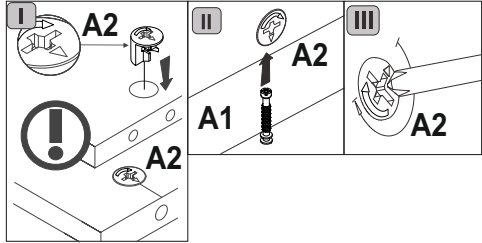
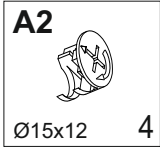

8

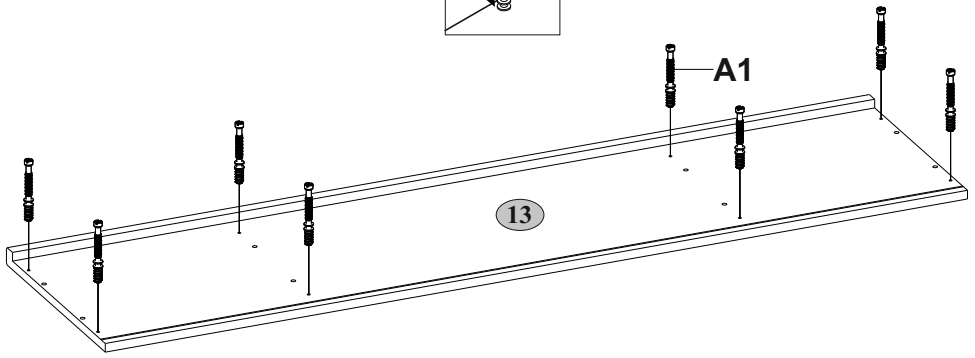
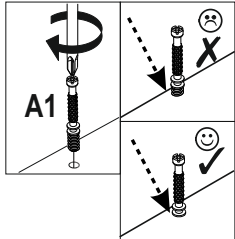
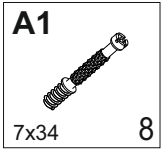



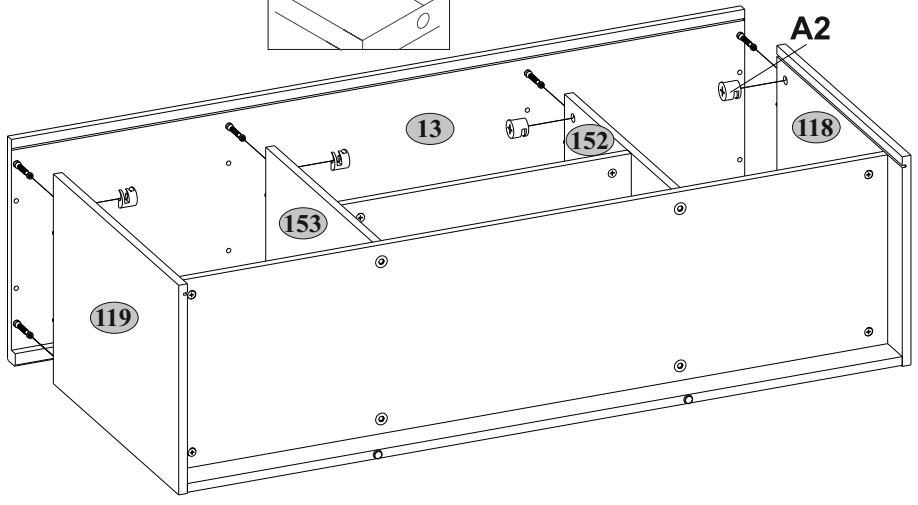
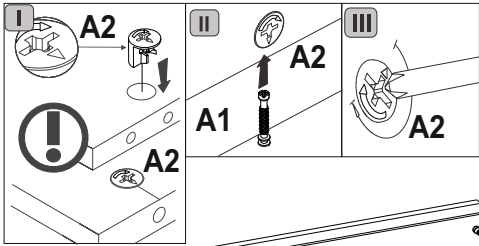
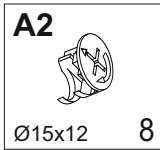

9

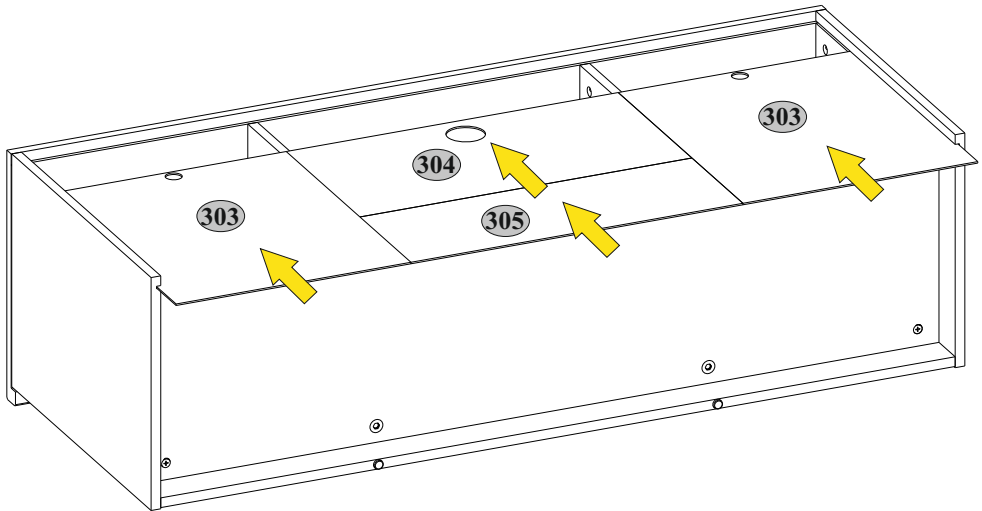

10







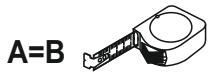
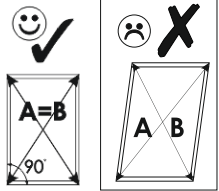
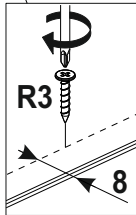
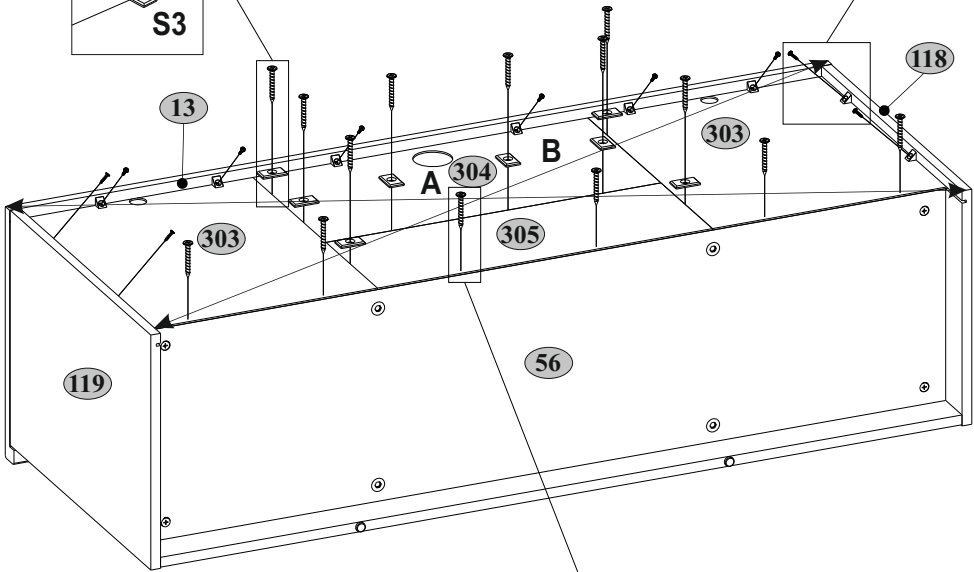
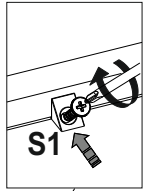
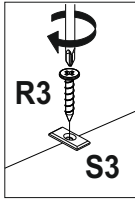

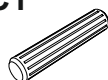

11

R3  3x20	S1  14	S3  10	S3  8
--	--	--	---

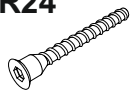

12

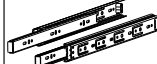
A1  7x34 4	A2  Ø15x12 4	C1  8x35 4	I  S4 1	H58  1
R24  7x50 4	R27  5,0x13 4	R32  4x27 2	S5  Ø18 4	Z10  300 1

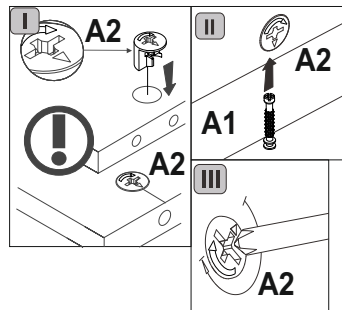
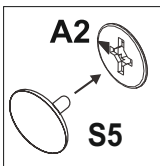
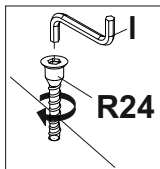
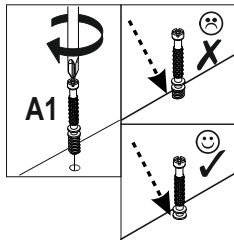
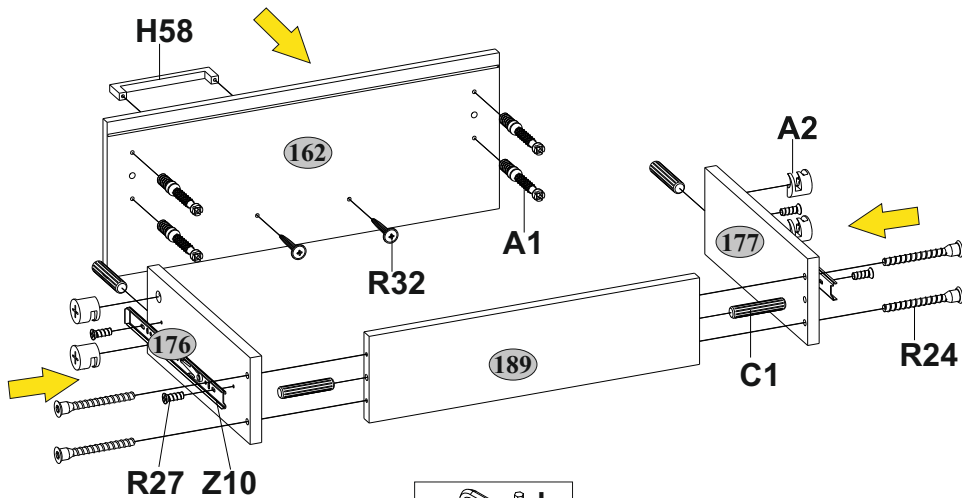
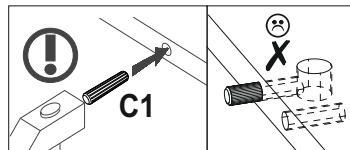
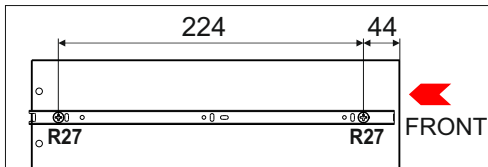

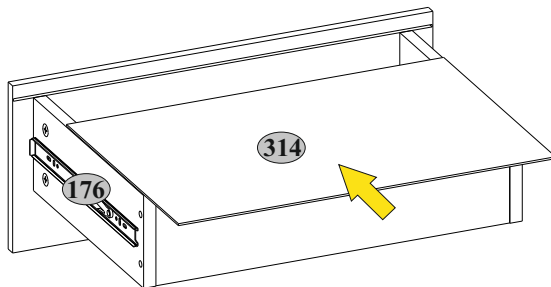

13

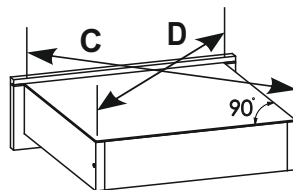
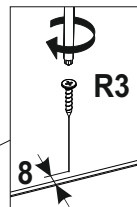
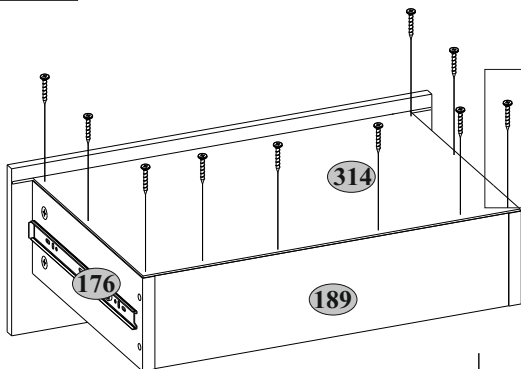
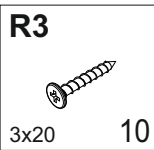

14





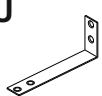

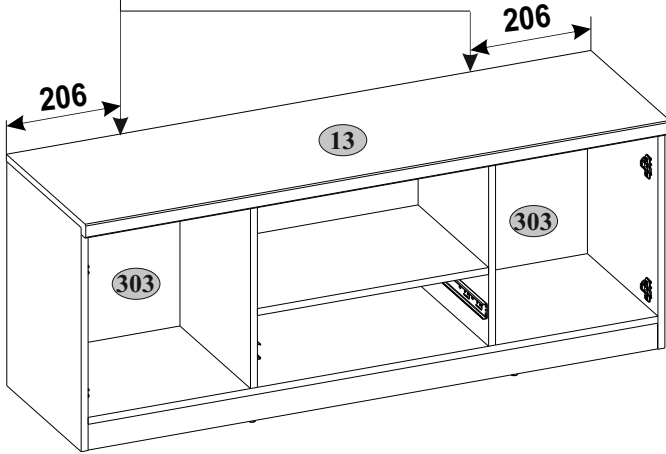
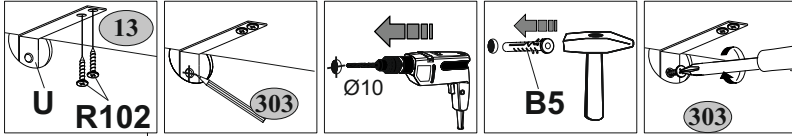
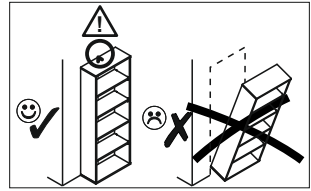
15

B5  10x50	R102  3,5x16	U  130x35x15
2	4	2

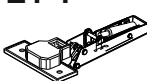

16

E1-1  4	H58  2	R32  4x27
	R102  3,5x16	4
	8	

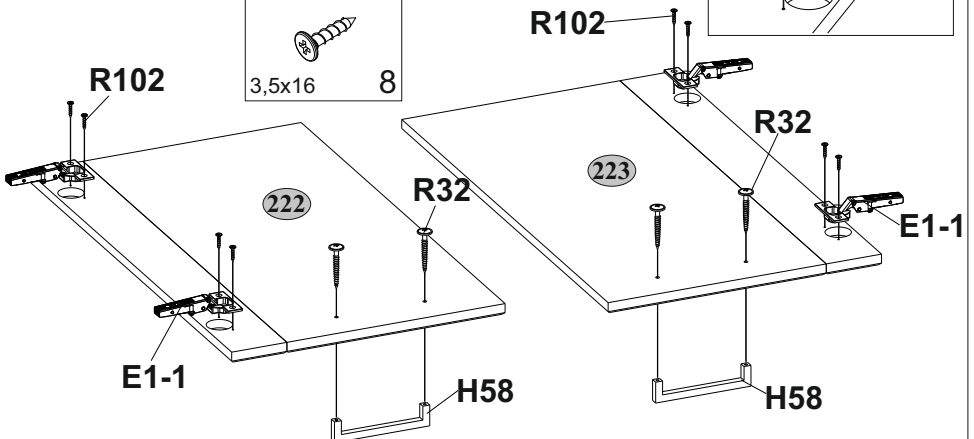
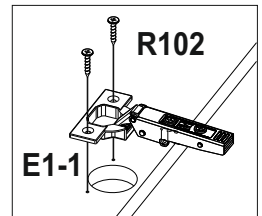

17

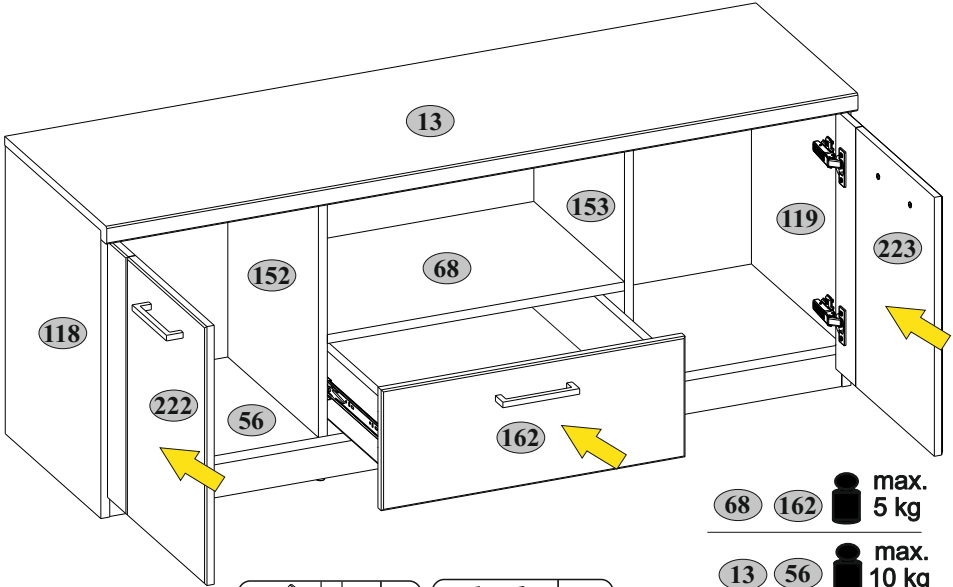
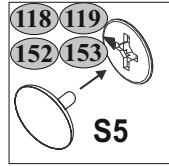
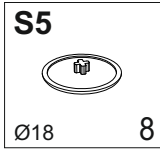

68 162 max. 5 kg
13 56 max. 10 kg

