

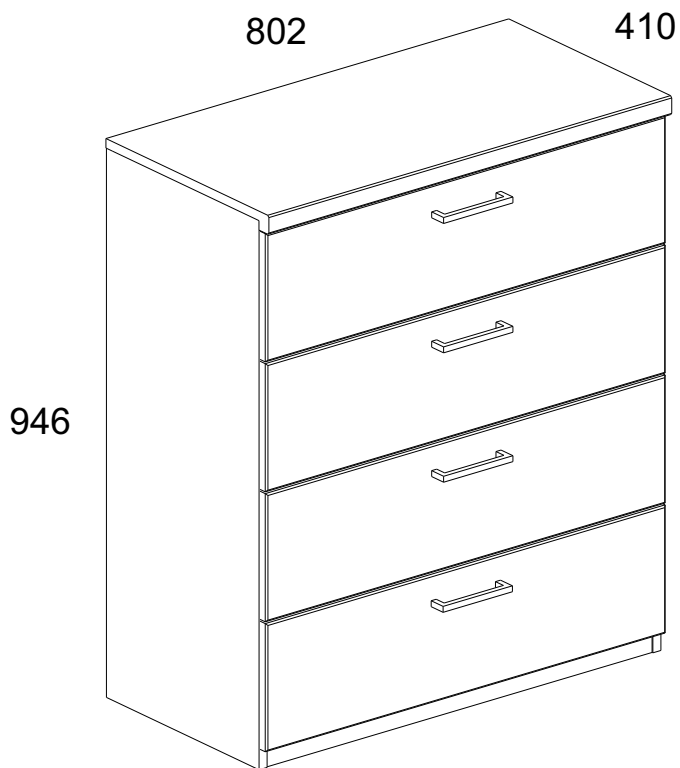

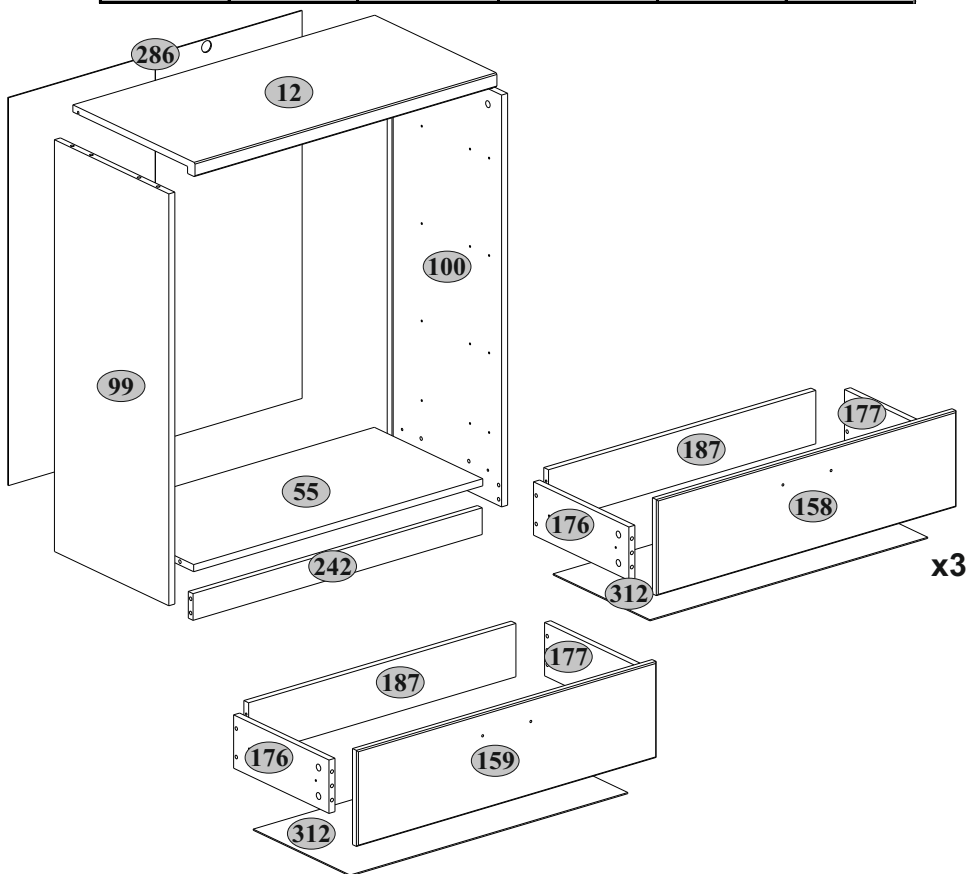

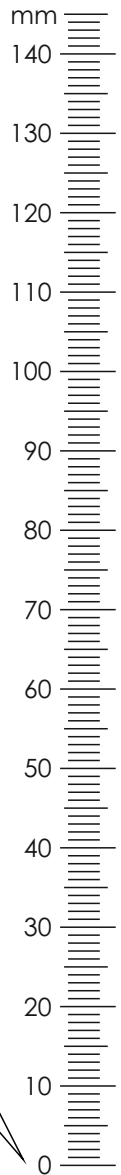









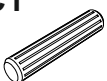

DORSI 4S

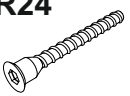

	L, mm	B, mm	H, mm	Q	
12	802	410	32	1	1/2
55	768	364	16	1	1/2
99	926	384	16	1	2/2
100	926	384	16	1	2/2
158	796	216	16	3	1/2
159	796	216	16	1	1/2
176	320	120	16	4	2/2
177	320	120	16	4	2/2
187	710	120	16	4	2/2
242	768	60	16	1	1/2
286	872	780	2,5	1	2/2
312	740	325	2,5	4	1/2





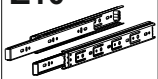

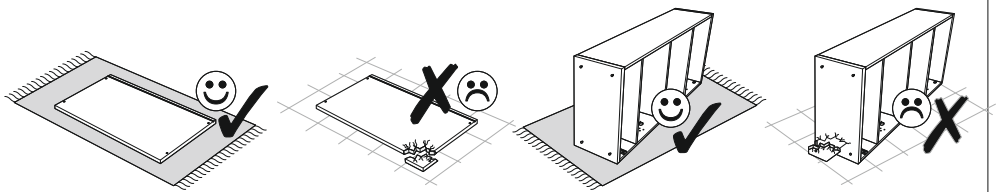
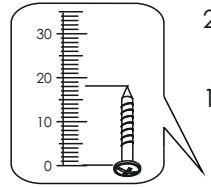
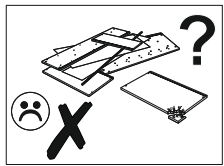
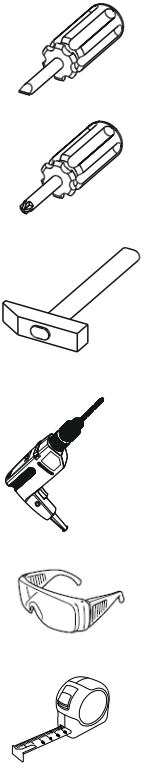
A1  7x34 24	A2  Ø15x12 24	B5  10x50 1	C1  8x35 28
H58  4	I  S4 1	L1  320 4	N1  4
R3  3x20 44	R24  7x50 16	R27  5,0x13 40	R32  4x27 8
R102  3,5x16 10	S1  8	S5  Ø18 16	U  130x35x15 1
Z10  300 4			

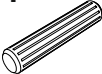

1

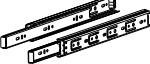
A1  7x34 4	C1  8x35 4	N1  4	R27  5,0x13 24	Z10  300 4
---	---	---	---	---

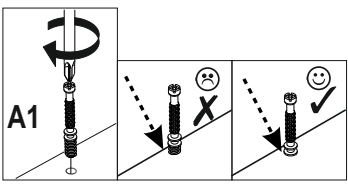
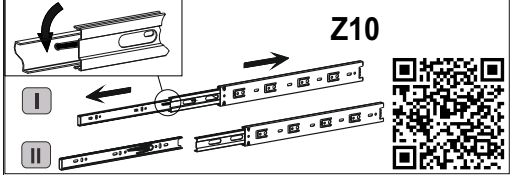
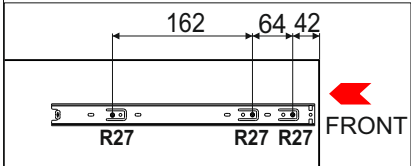
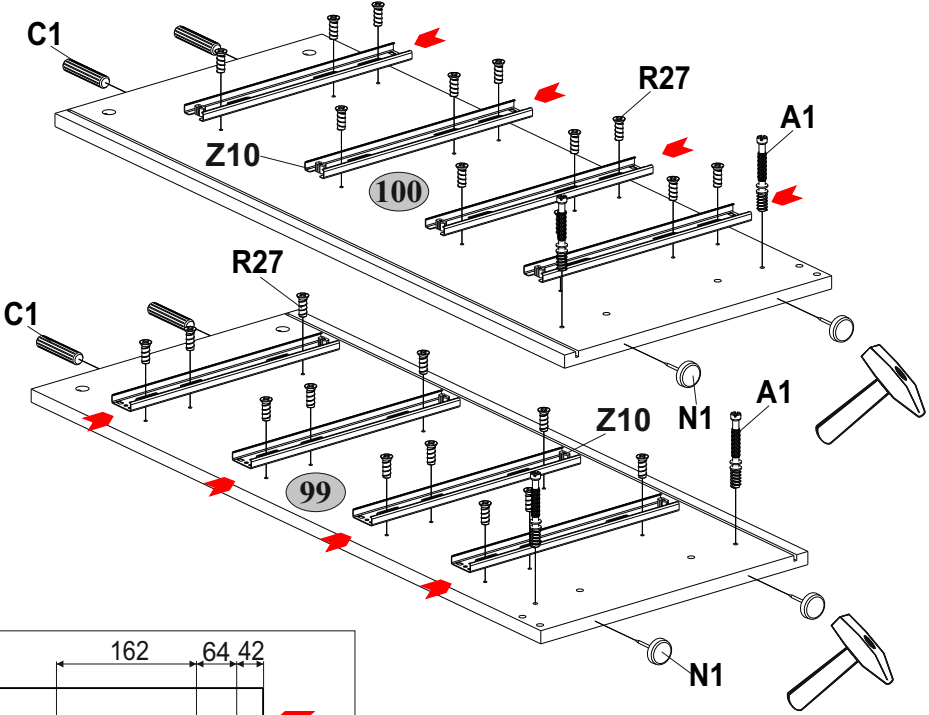
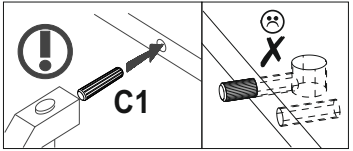

2

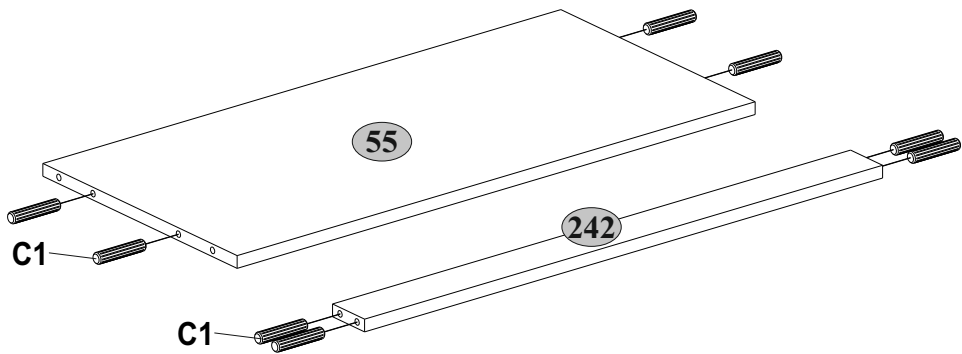
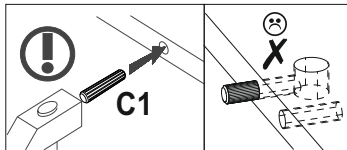
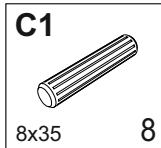

3

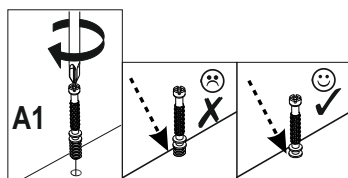
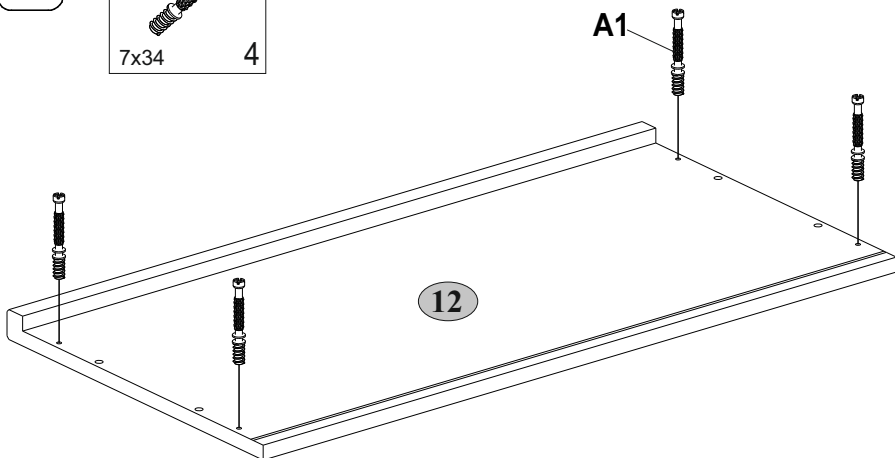
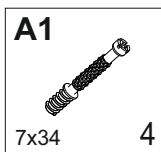

4

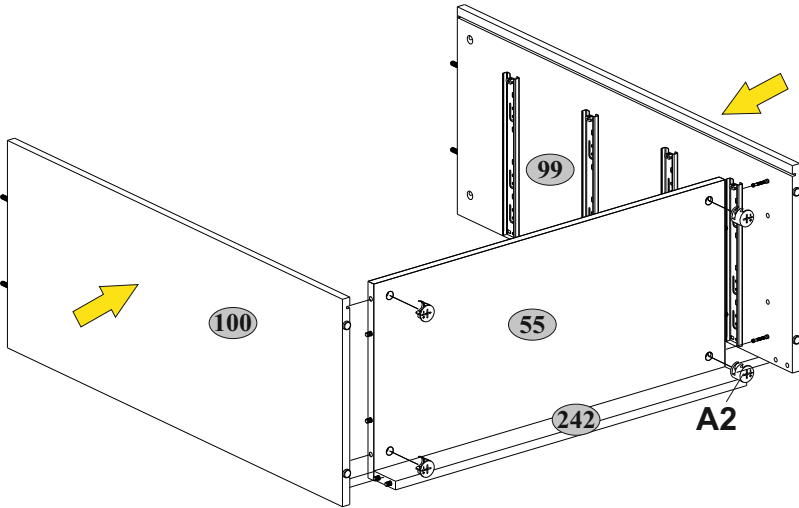
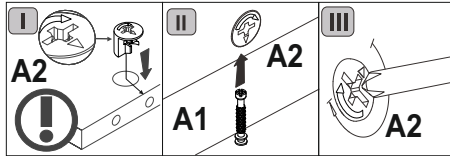
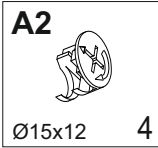

5

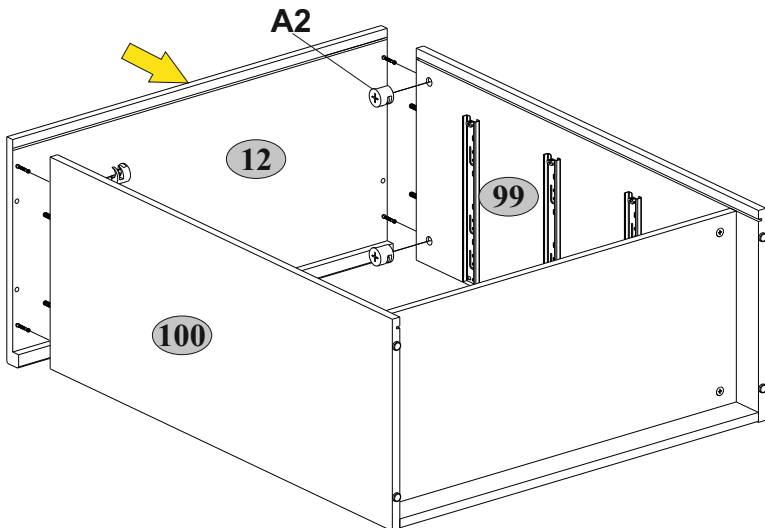
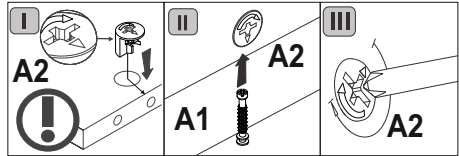
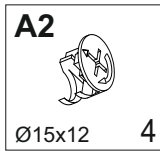

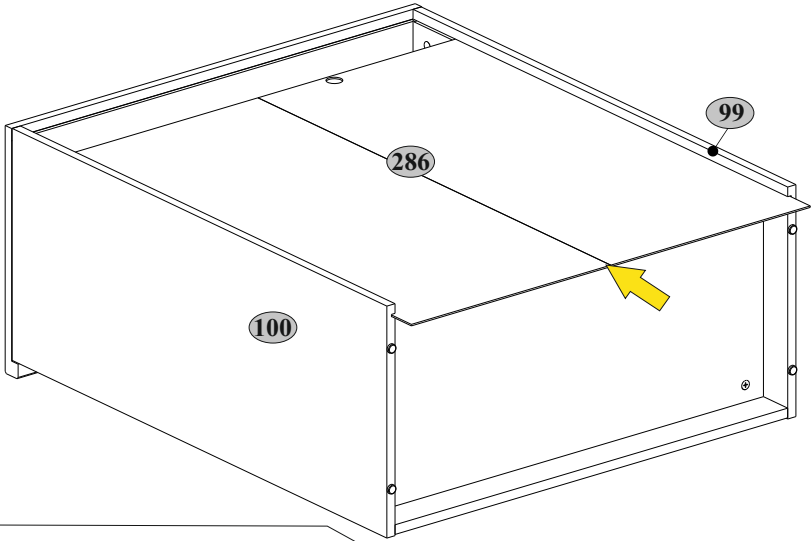

6

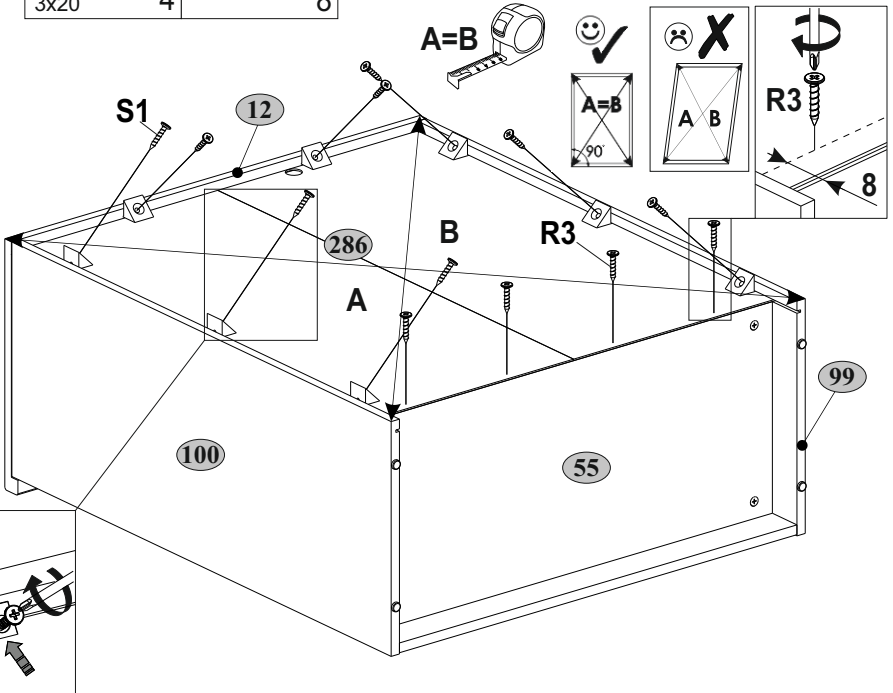
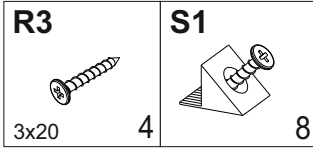

7





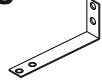

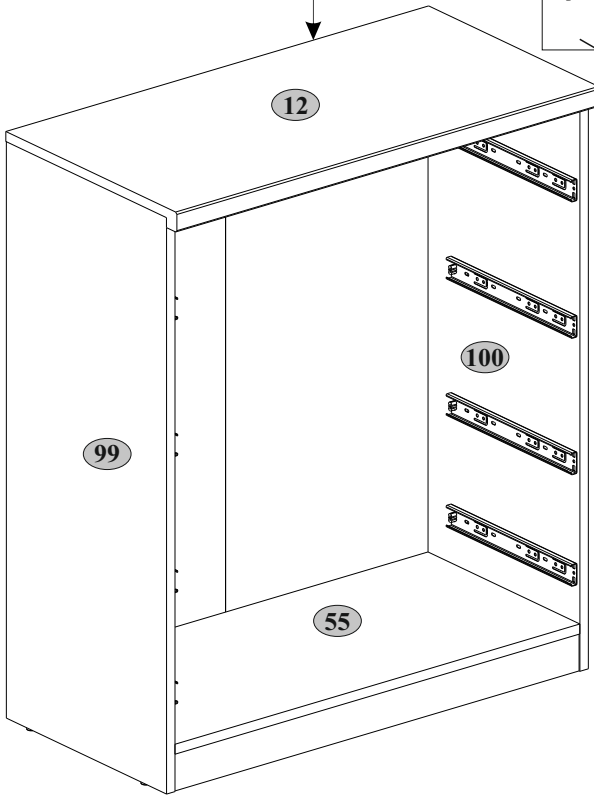
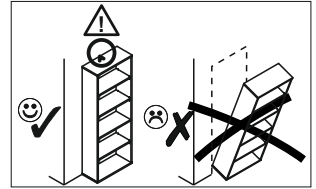
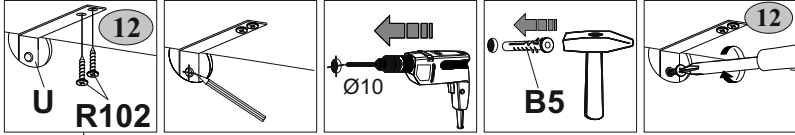

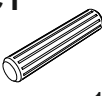

8

B5  10x50 1	R102  3,5x16 2	U  130x35x15 1
---	--	--



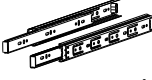

9**x4**

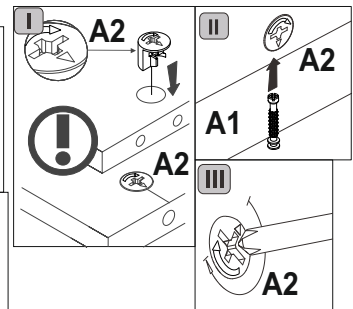
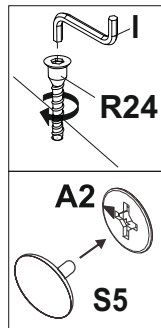
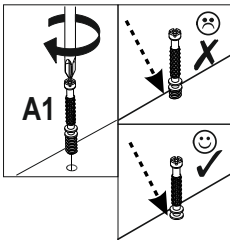
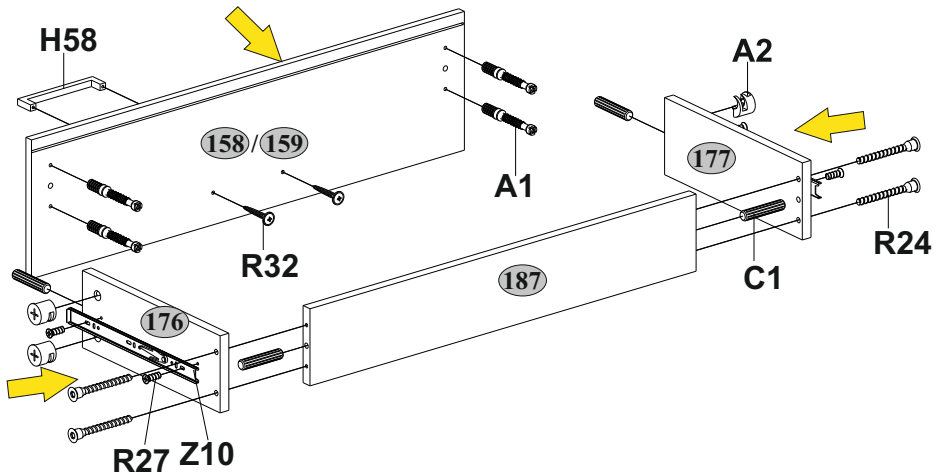
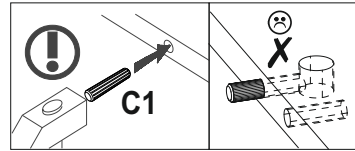
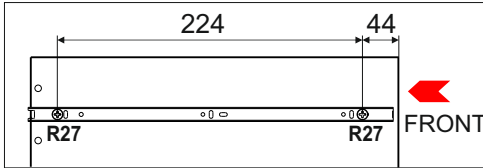
A1  7x34 16	A2  Ø15x12 16	C1  8x35 16	I  S4 1	H58  4
R24  7x50 16	R27  5,0x13 16	R32  4x27 8	S5  Ø18 16	Z10  300 4

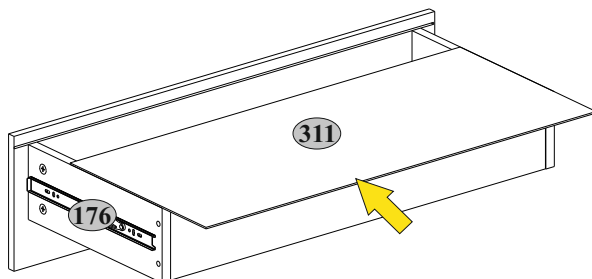

10**x4****11****x4**

L1	R3	R102
		
320	4	40
	3x20	3,5x16
		8

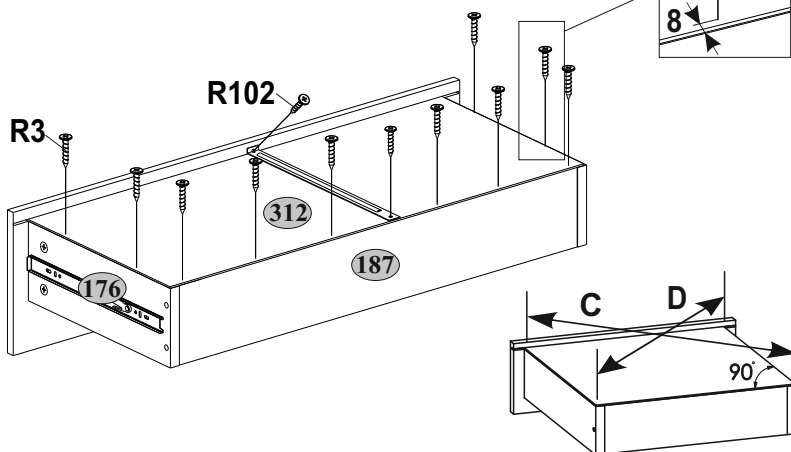

12

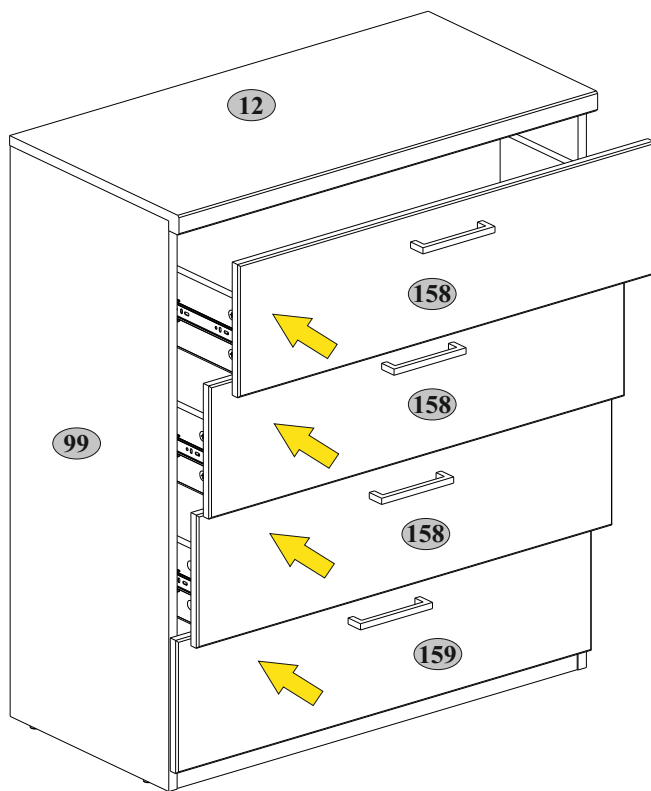

12 158 159  max.
5 kg

