

MICHIGAN NEW 140

Art.-Nr.

338 754
338 755

↔	1445
↕	750
↗	2052
	mm

1/8
VO

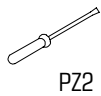
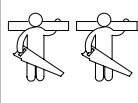

PZ2

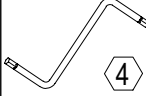

4



0,5 kg



3m

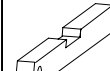

600 mm

ID EE	ID	Image	Dimensions	Quantity	Notes
19255	②		1445*600*16	1x	2/2
19239	③		244*190*16	2x	1/2 2/2
19256	④		1445*120*16	1x	2/2
19241	⑤		2004*194*16	1x	1/2
19242	⑥		2004*194*16	1x	1/2
19258	⑦		2004*244*16	1x	1/2
19257	⑧		1445*396*16	1x	2/2
19244	⑨		244*361*16	2x	1/2
19245	⑩		800*360*16	1x	2/2
19246	⑪		828*242*3	1x	2/2
19247	⑫		598*188*16	1x	2/2
19248	⑬		598*188*16	1x	2/2
19025	⑭		350*120*16	2x	2/2
19249	⑮		528*120*16	2x	2/2
19027	⑯		350*120*16	2x	2/2
19250	⑰		556*356*3	2x	2/2

A

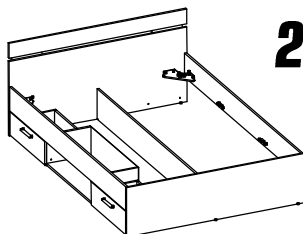

2x 100 kg

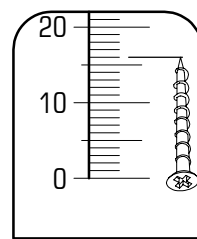
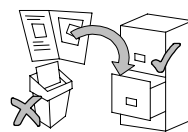
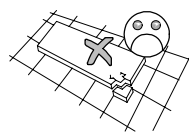
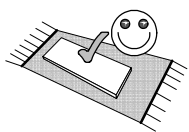
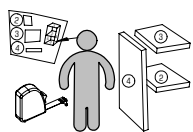
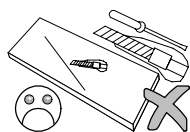
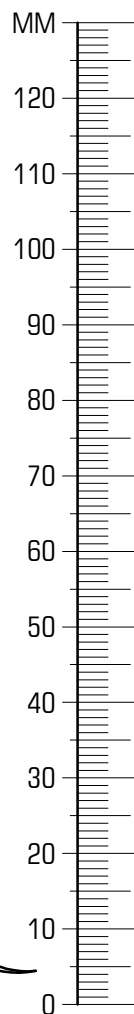
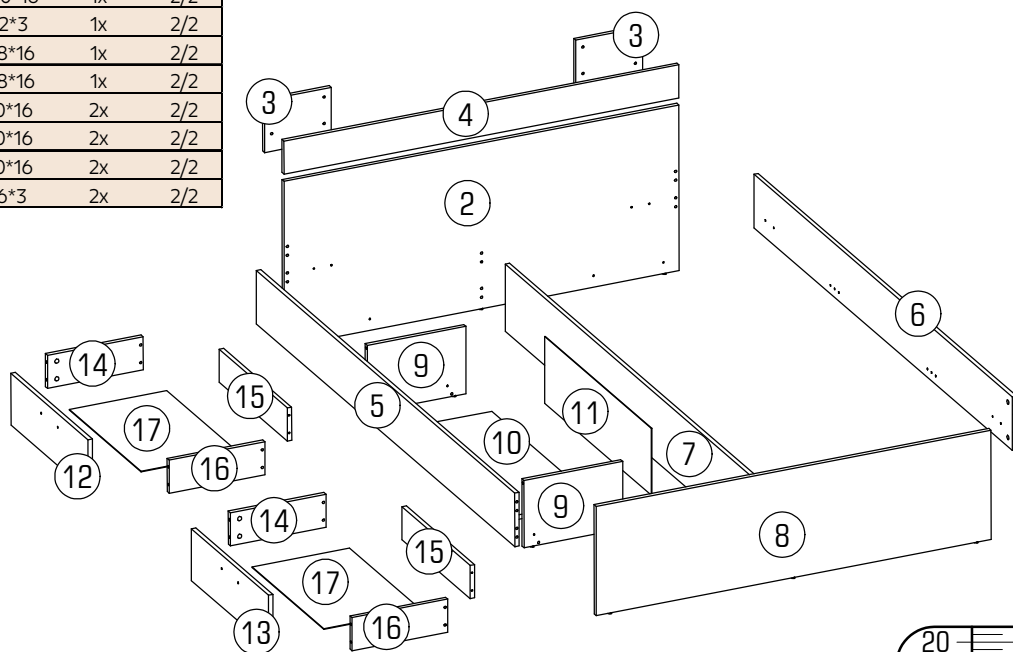
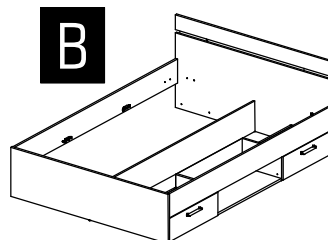

B

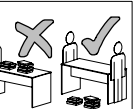
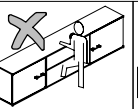
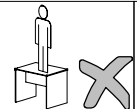
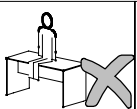
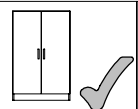
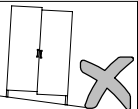
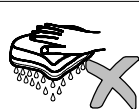

21102,00		∅1,6x20	22232,00		∅4,0x16	22243,00		∅3,5x15	22300,00		∅7x50	22430,00		∅4x25	22453,00		M6x25	22705,00		∅6,8x8	22707,00		∅6,3x11
A	25x		B	4x		C	16x		D	18x		E	4x		F	8x		G	8x		H	16x	
22800,01		4	24091,00		∅10x11	27000,00		∅8x30	30091,00		14x	70013,01		∅15x13	70021,01		16x		Q	8x		R	4x
J	1x		K	8x		L	12x		M	14x		N	16x		P	16x		Q	8x		R	4x	
31108,01		44x23x23	32030,00		L=150	33006,01		L=350	33006,01		L=350												
S	2x		T	2x		U	2x		V	2x													



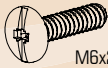

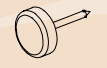

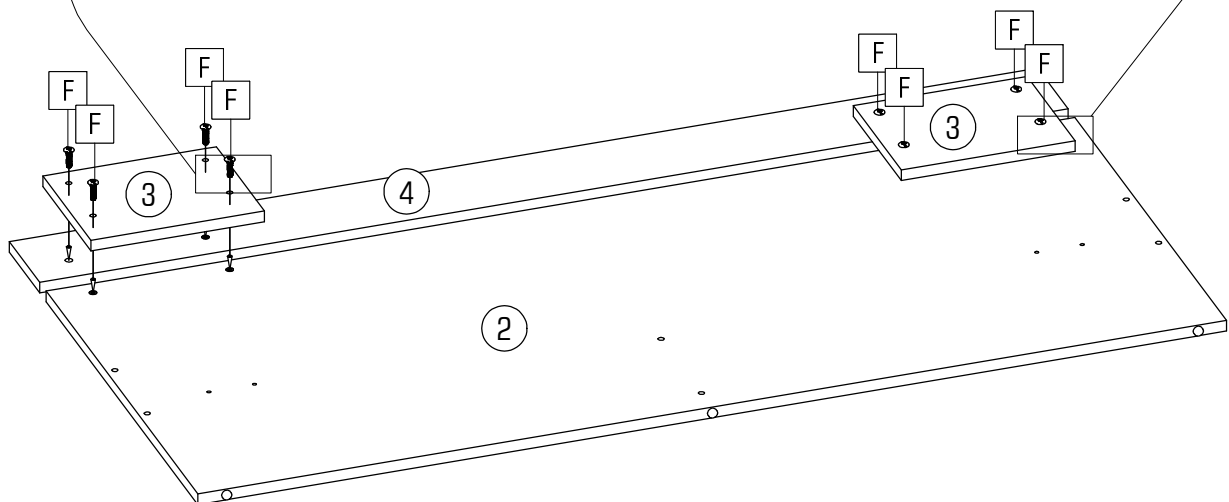
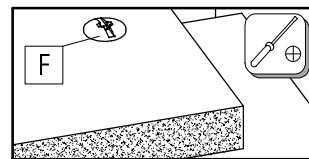
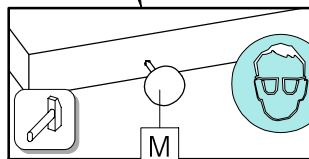
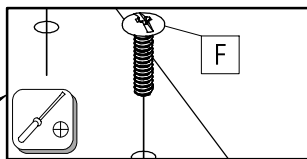
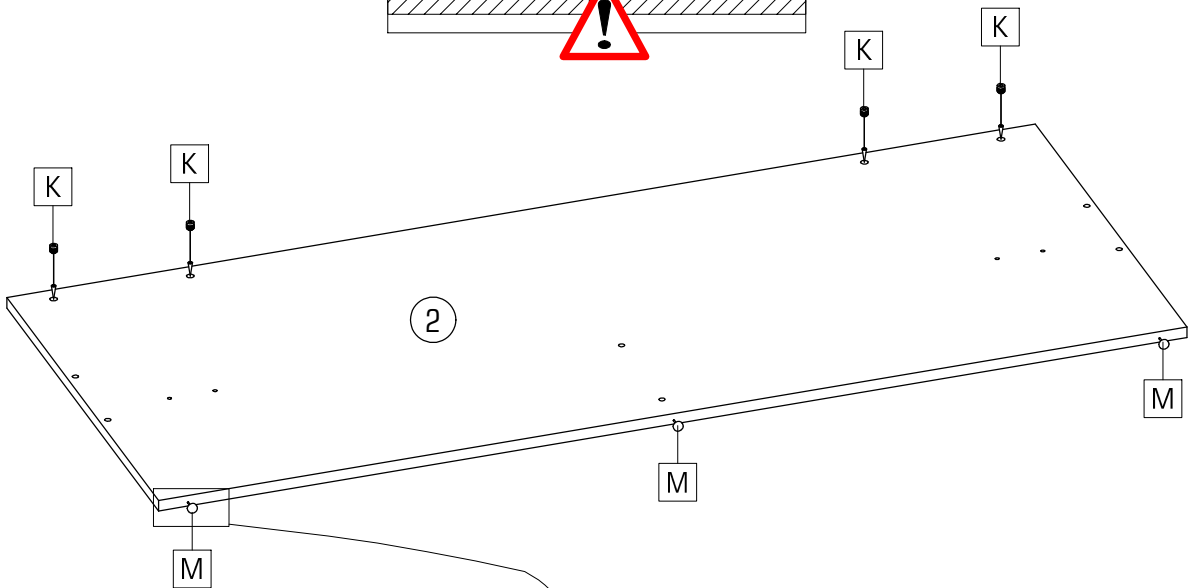
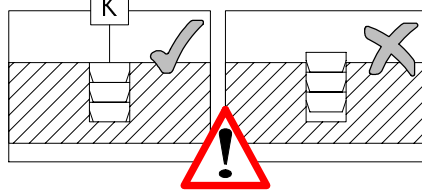
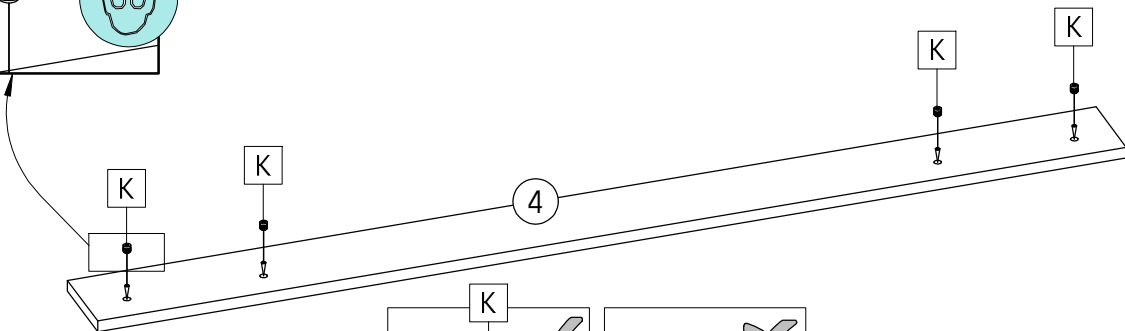
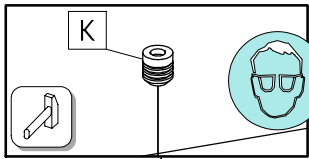
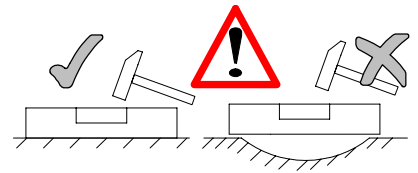
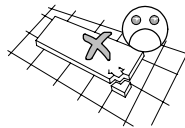
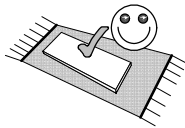
2/8 MICHIGAN NEW 140

	M6x25		Ø10x11		
F	8x	K	8x	M	3x



MICHIGAN NEW 140 3/8

			
L 12x	M 7x	N 6x	P 6x

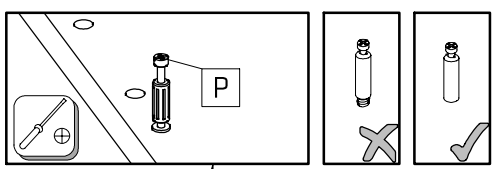
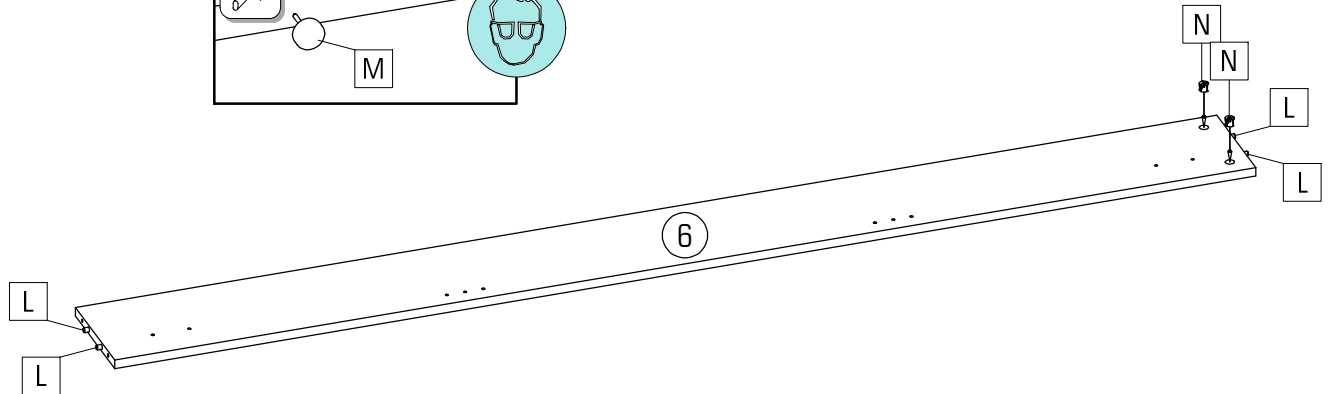
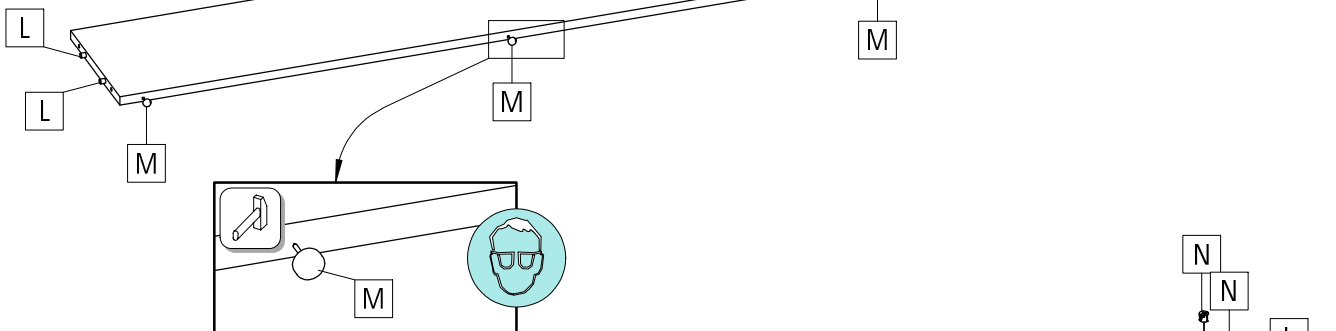
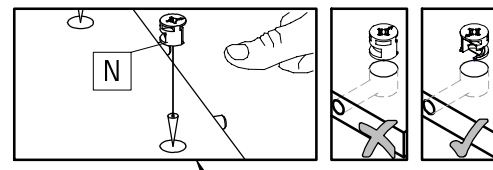
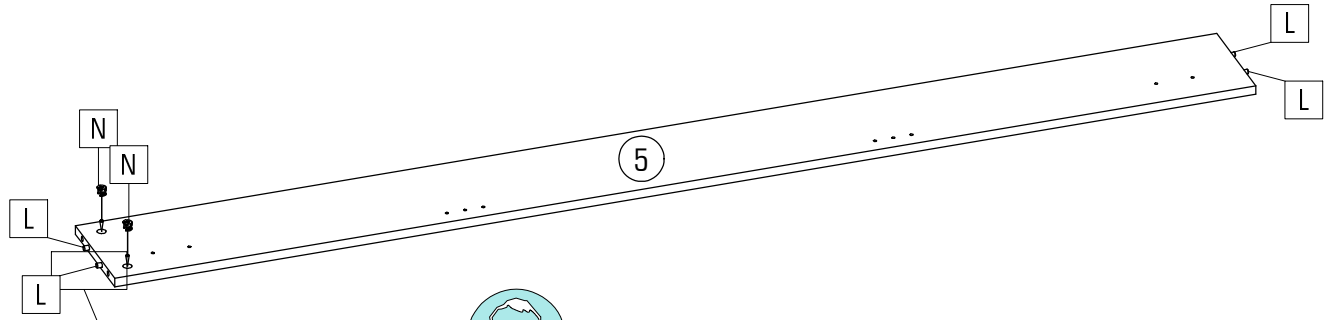
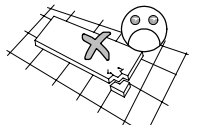
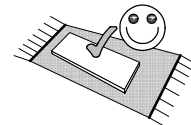

4/8 MICHIGAN NEW 140



Ø7x50

D



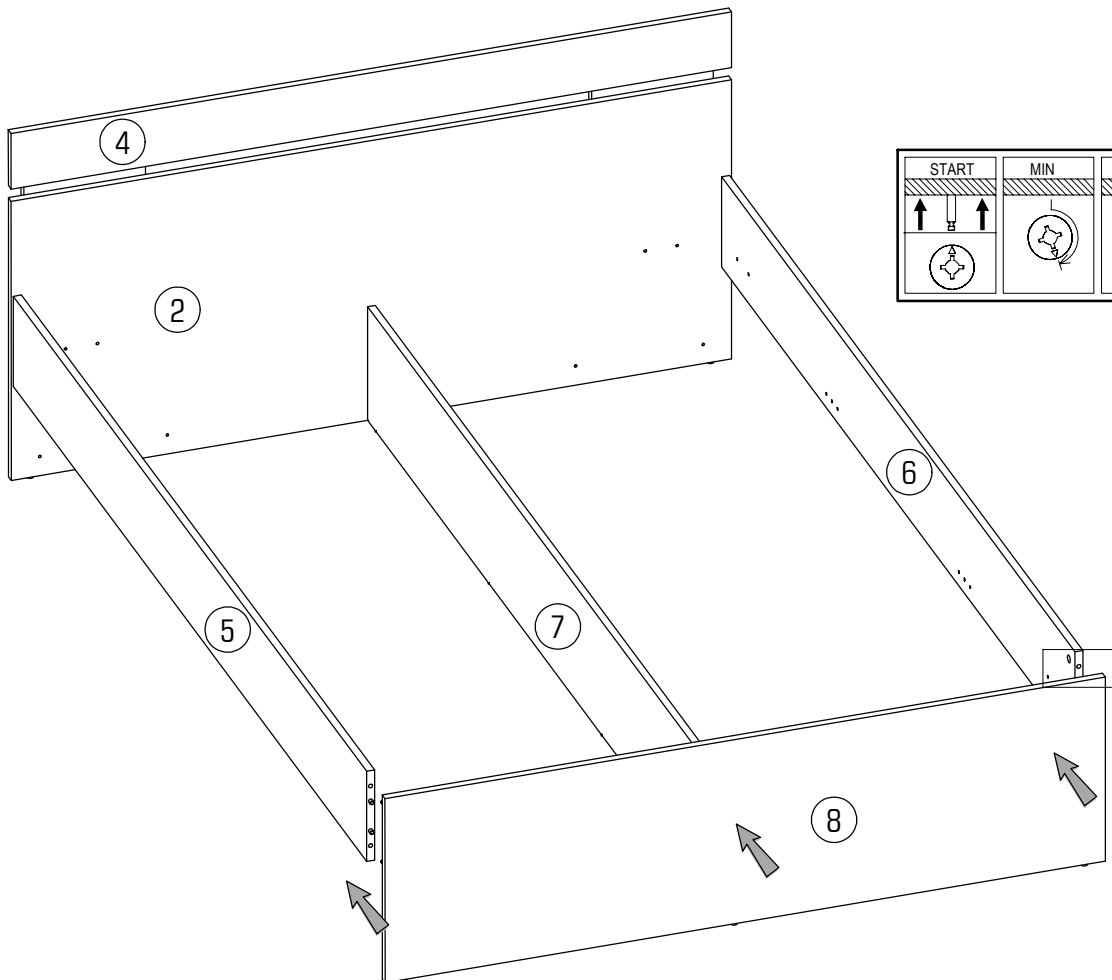
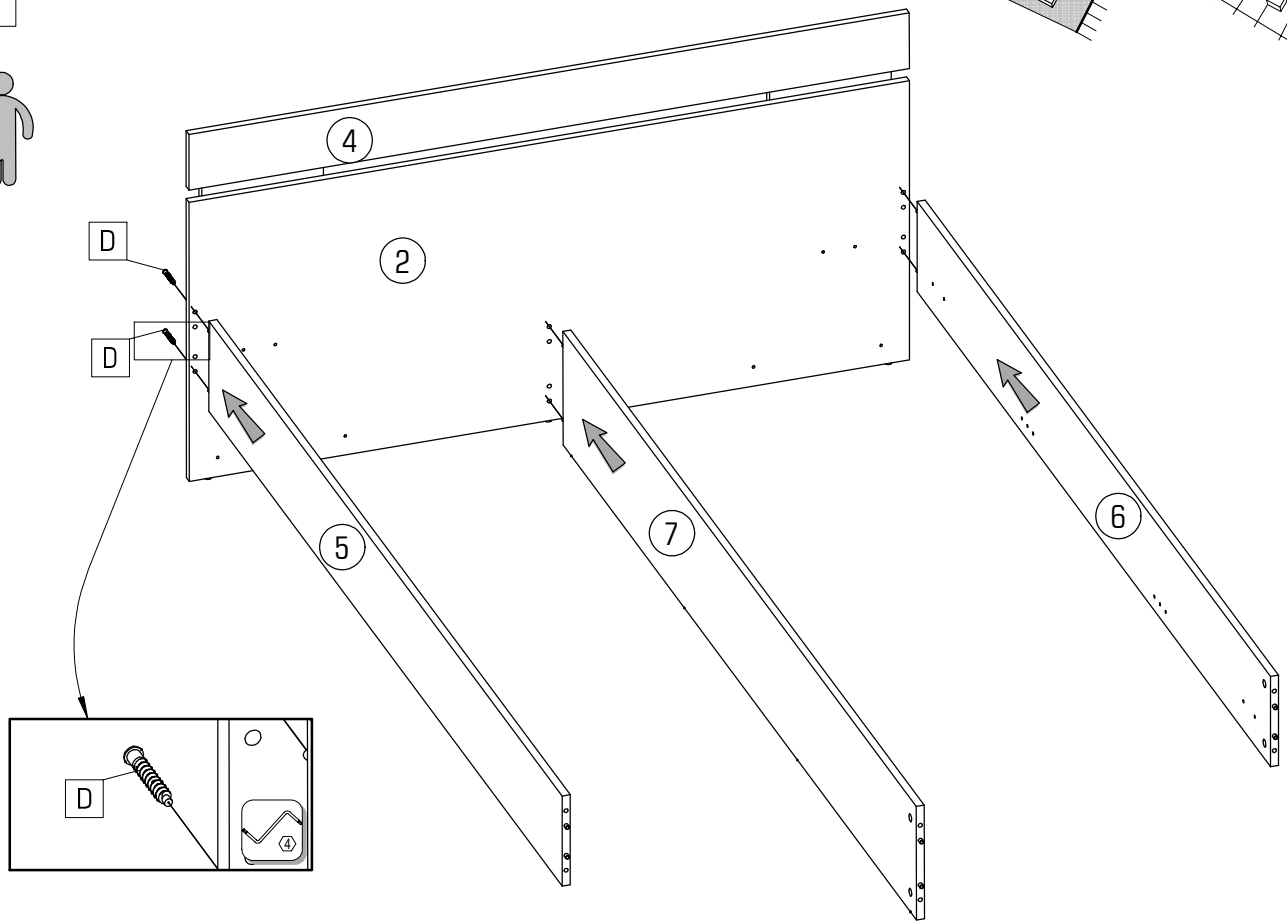
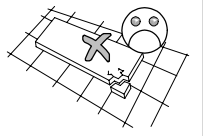
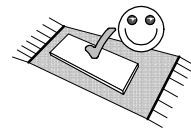
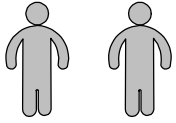

6x

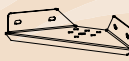

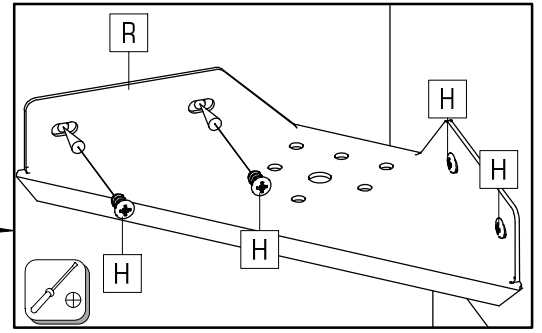
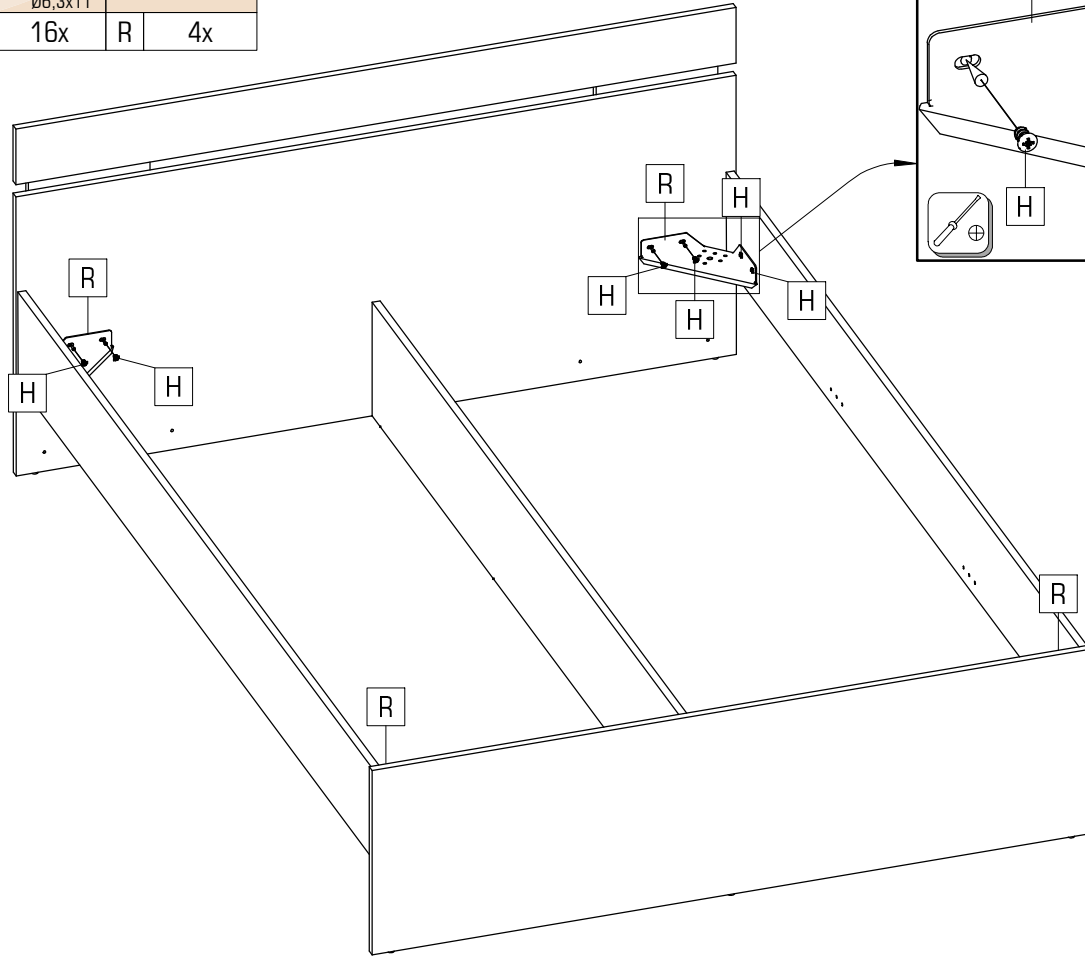





MICHIGAN NEW 140 5/8



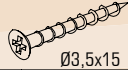

	
Ø6,3x11	
H 16x	R 4x



		Ø6,8x8
G 8x		
		Ø6,3x11
H 16x		



						
Ø3,5x15	Ø7x50	Ø6,8x8		Ø15x13	L=350	
C 2x	D 4x	G 4x	M 4x	N 2x	U 1x	



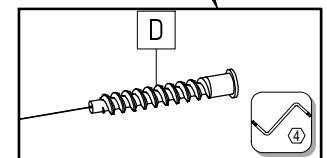
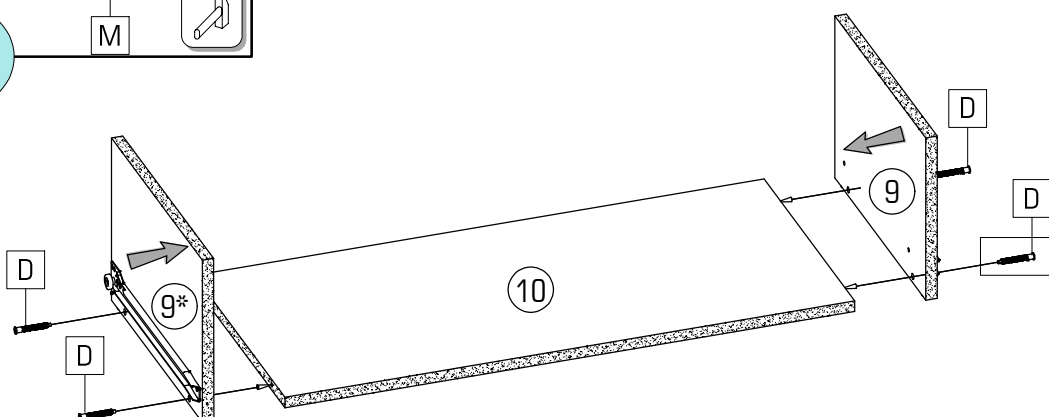
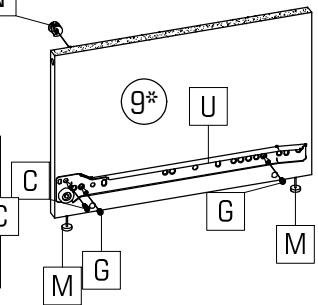
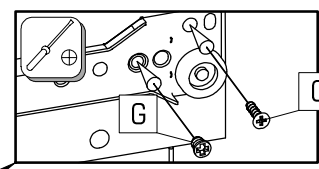
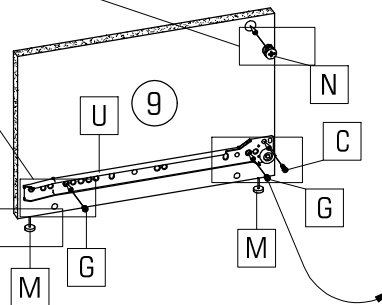
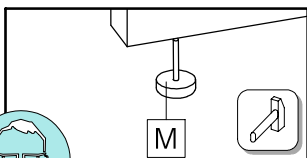
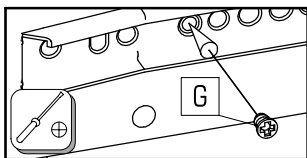
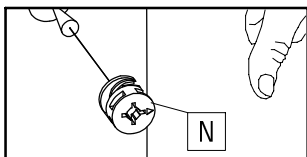



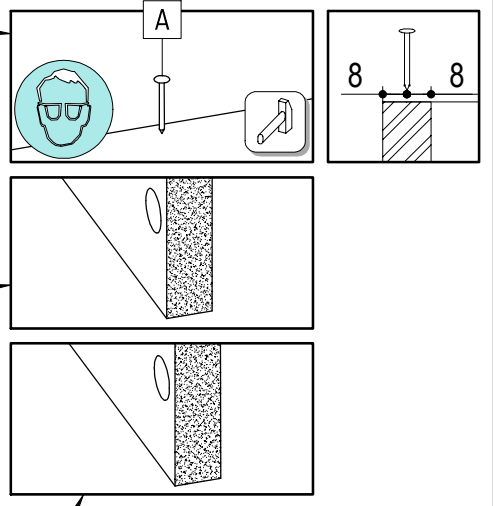
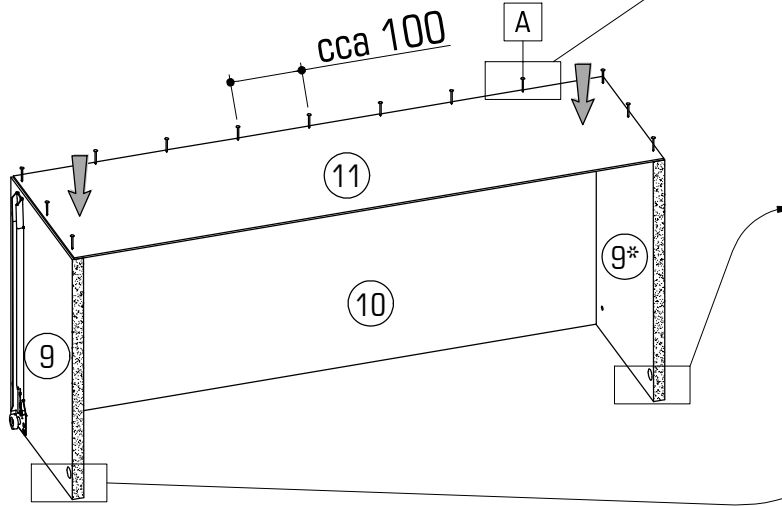

		Ø6,8x8
G 8x		
		Ø6,3x11
H 16x		

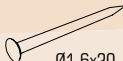
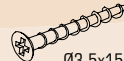

6/8 MICHIGAN NEW 140

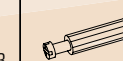



	Ø1,6x20
A	15x

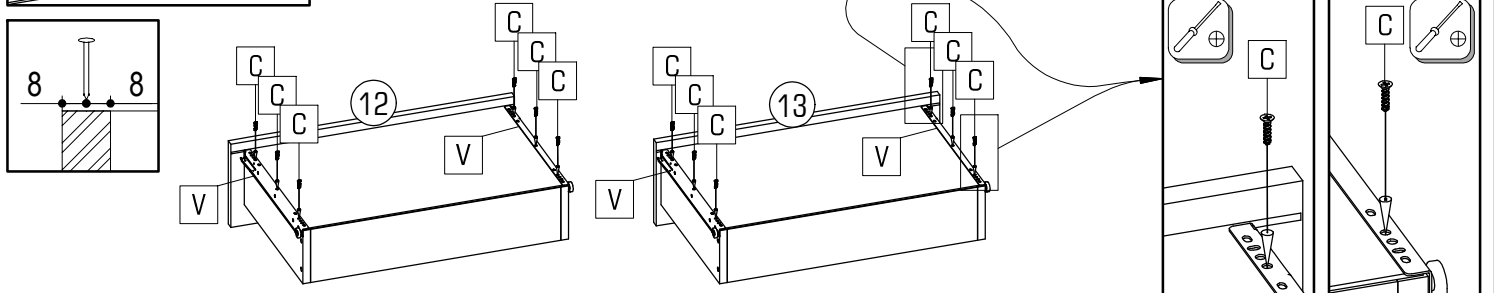
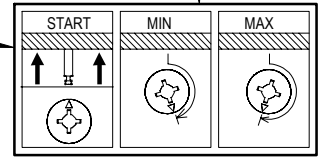
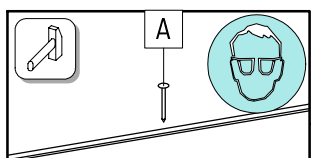
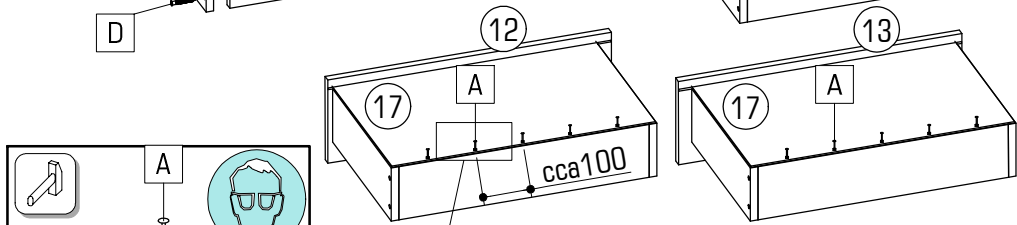
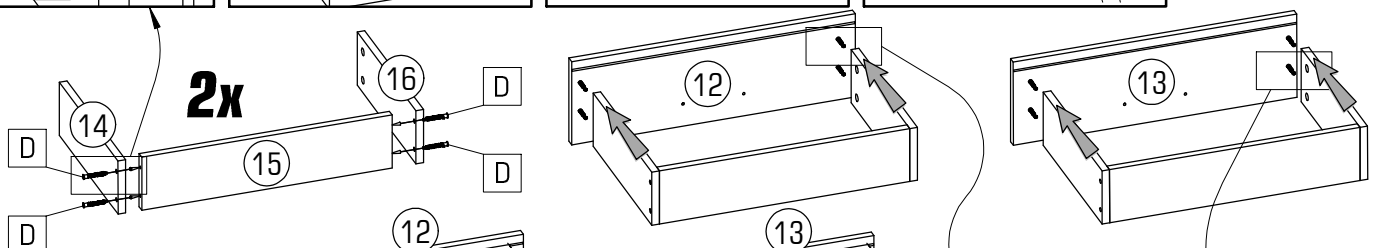
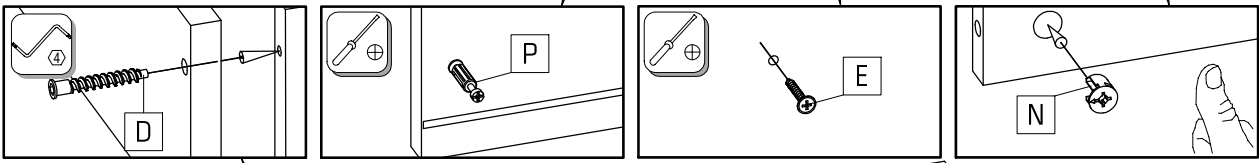
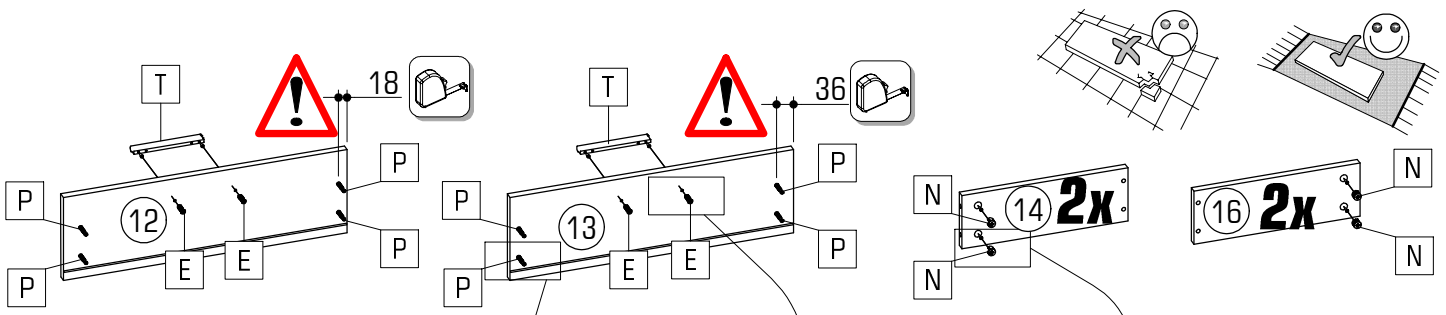

	Ø1,6x20		Ø3,5x15		Ø7x50		Ø4x25		Ø15x13						L=150		L=350
A	10x	C	12x	D	8x	E	4x	N	8x	P	8x	Q	8x	T	2x	V	2x



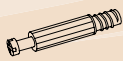

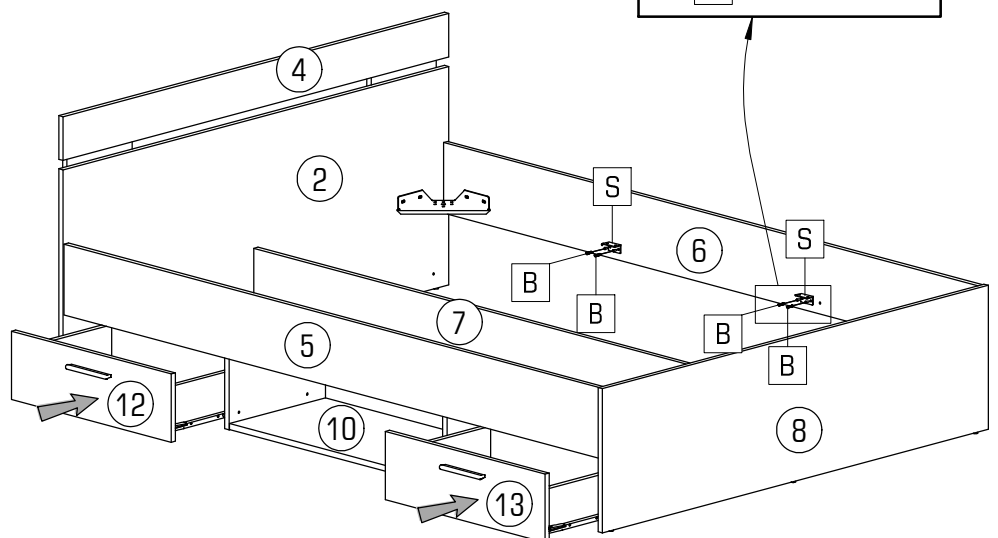
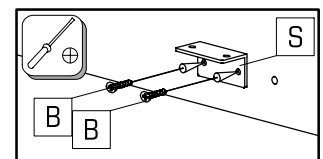
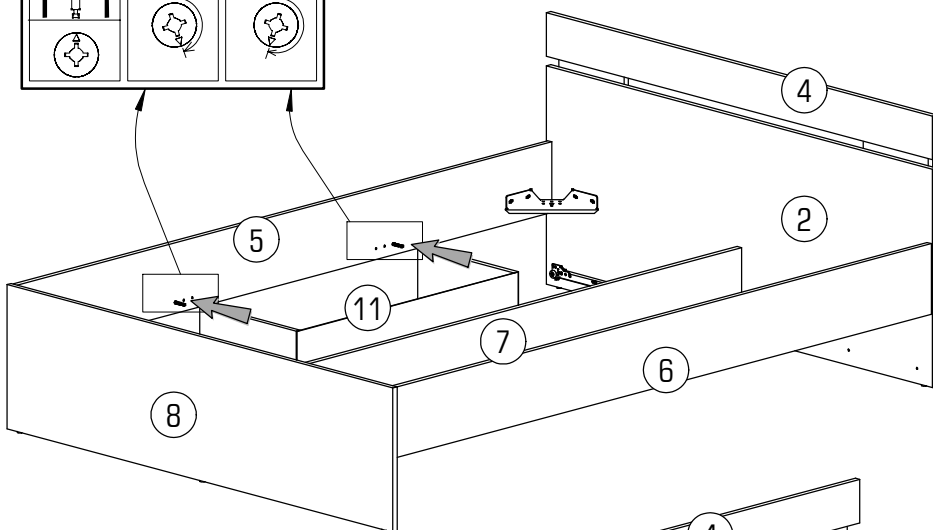
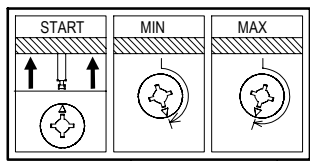
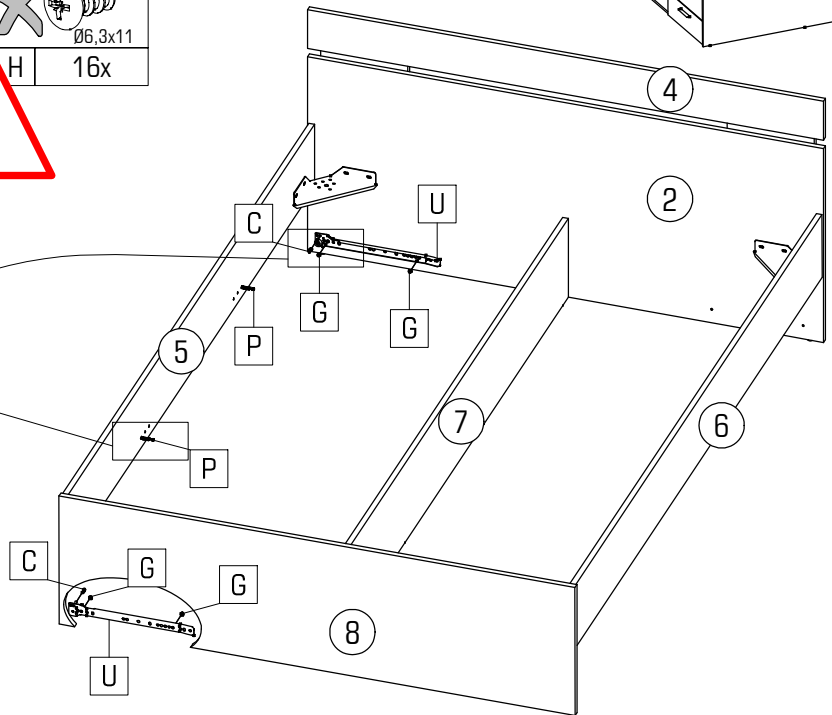
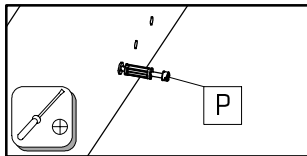
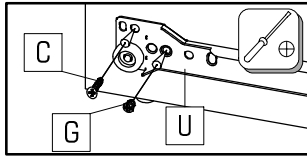
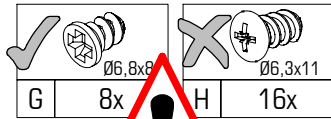
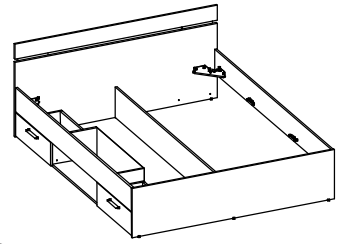

MICHIGAN NEW 140 7/8

					
B 4x	C 2x	G 4x	P 2x	S 2x	U 1x

A



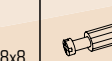

8/8 MICHIGAN NEW 140

					
B 4x	C 2x	G 4x	P 2x	S 2x	U 1x
$\varnothing 4,0 \times 16$	$\varnothing 3,5 \times 15$	$\varnothing 6,8 \times 8$		44x23x23	L=350

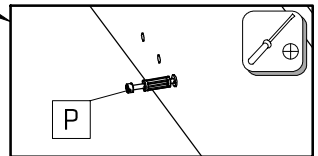
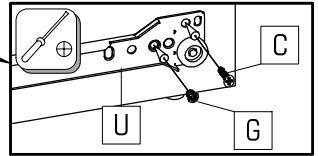
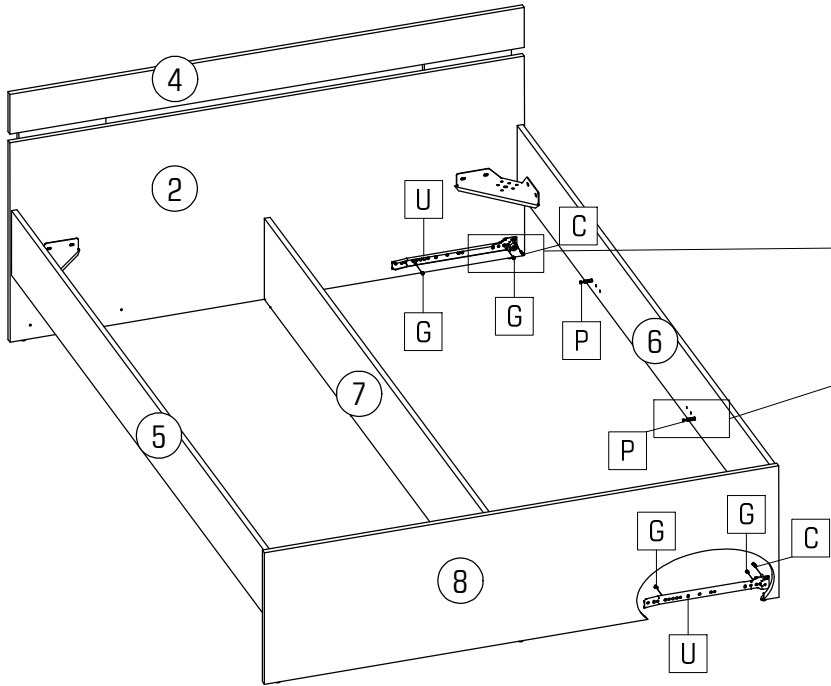
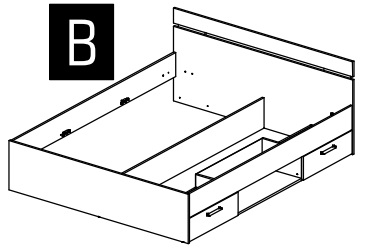
B



		
G 8x	$\varnothing 6,8 \times 8$	H 16x
	$\varnothing 6,3 \times 11$	

