

# HANY PC

	1180	<b>1/6</b>
	750	
	600	
	mm	

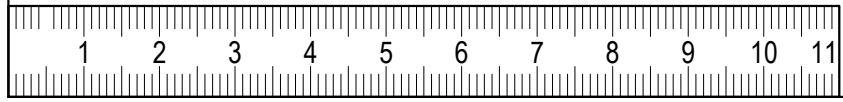

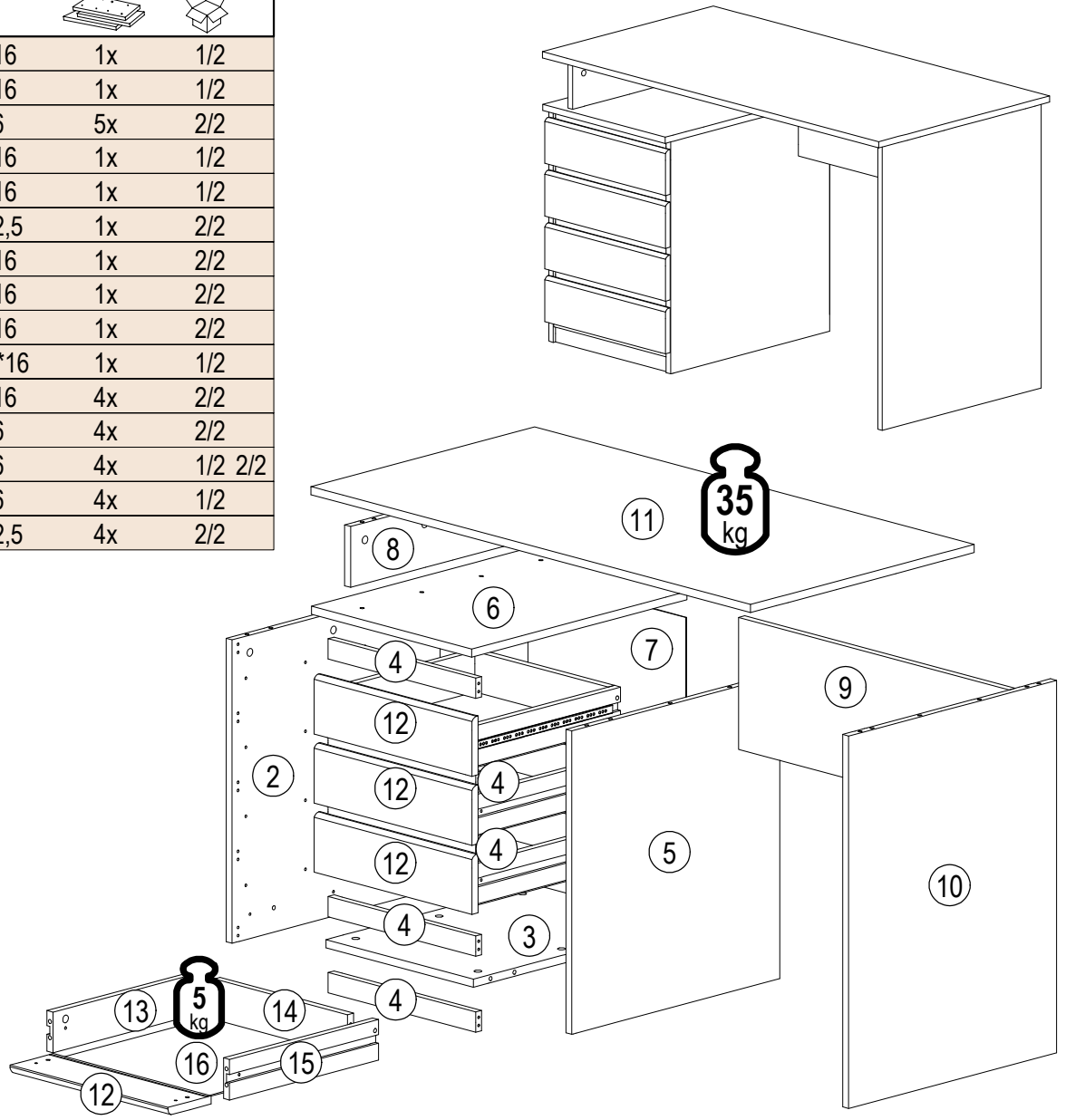

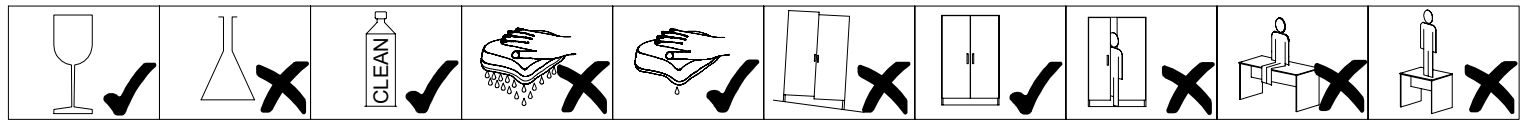

	 120 min		 PZ2	 4		 3m
--	-------------	--	---------	-------	--	--------

ID	ID			
14591	②	598*558*16	1x	1/2
14592	③	396*556*16	1x	1/2
14593	④	396*40*16	5x	2/2
14594	⑤	598*558*16	1x	1/2
14595	⑥	430*578*16	1x	1/2
14596	⑦	570*424*2,5	1x	2/2
14597	⑧	120*558*16	1x	2/2
14598	⑨	726*260*16	1x	2/2
14599	⑩	734*558*16	1x	2/2
14600	⑪	1180*600*16	1x	1/2
14601	⑫	424*116*16	4x	2/2
14602	⑬	400*80*16	4x	2/2
14603	⑭	358*80*16	4x	1/2 2/2
14604	⑮	400*80*16	4x	1/2
14605	⑯	406*388*2,5	4x	2/2





22300,00  A 14x	22502,00  B 8x	27000,00  C 28x	70021,01  D 30x	70013,01  E 30x	30090,00  F 6x	50553,00  G 8x	33018,00  H 4x	21102,00  J 25x	
27010,00  K 20x	 L 30x	22705,00  M 24x	22244,01  N 44x						

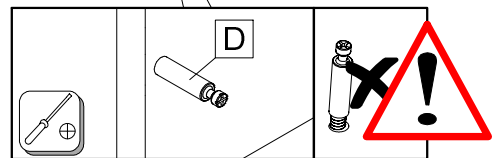
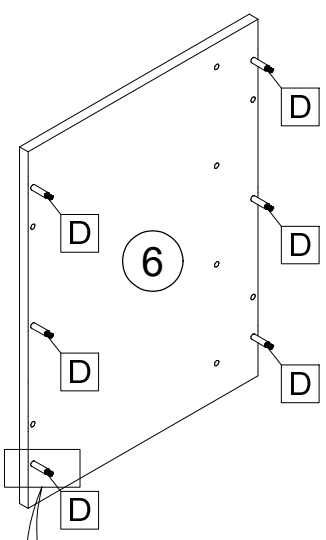
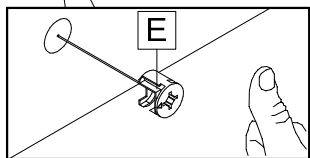
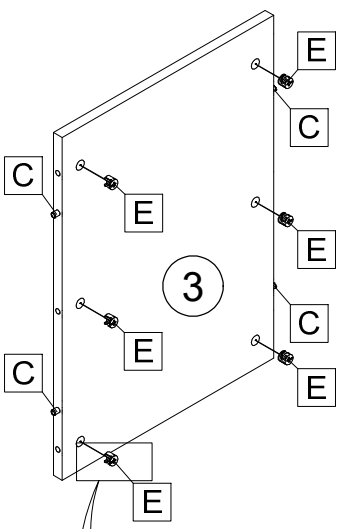
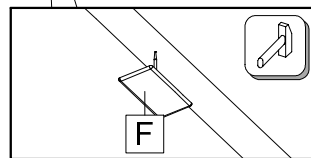
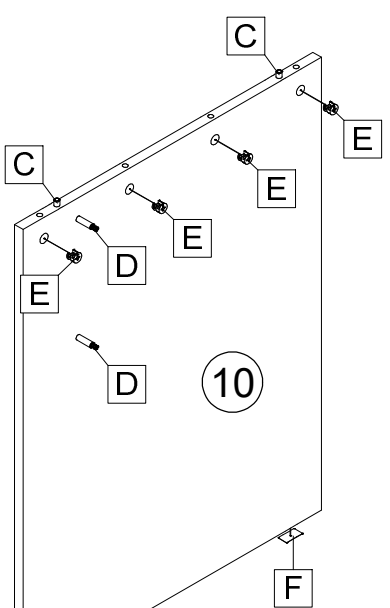
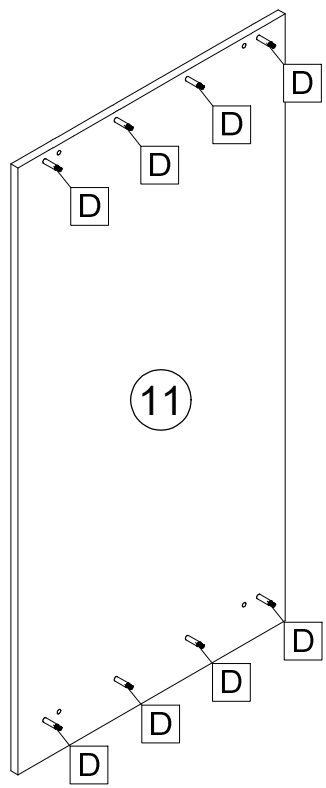
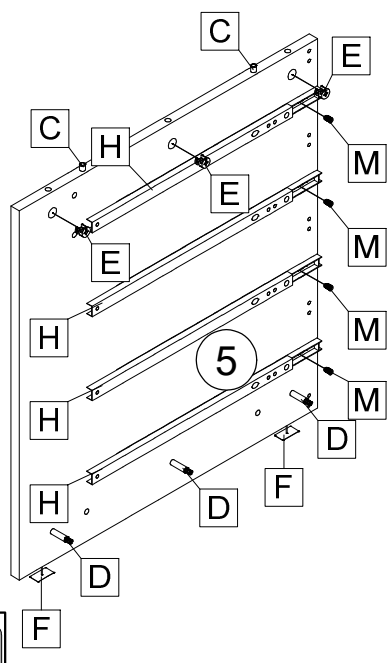
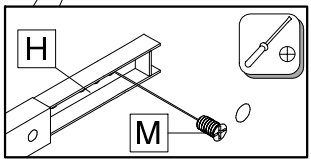
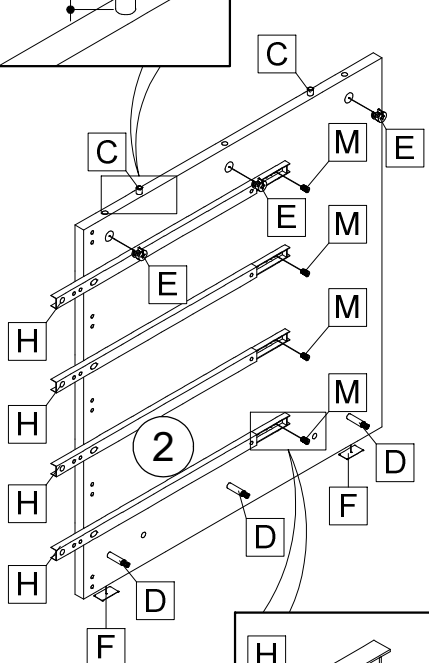
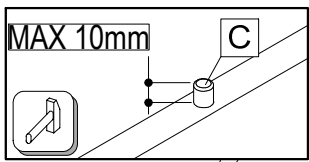
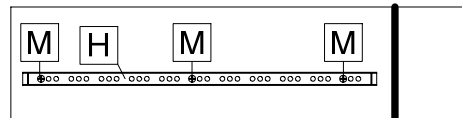

					
Ø 8x30				L=375mm	Ø6,3x8
C 10x	D 22x	E 16x	F 6x	H 4x	M 24x





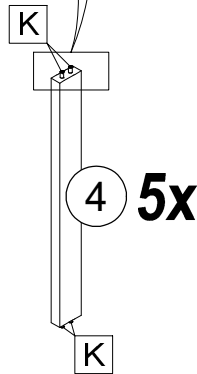
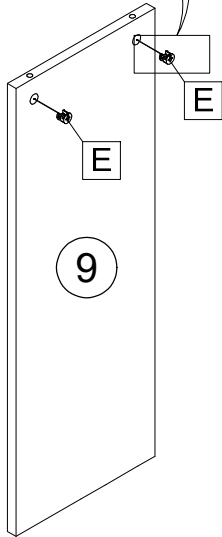
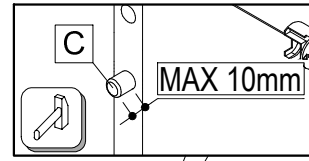
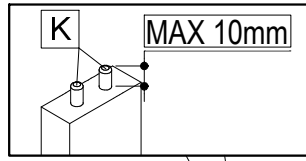
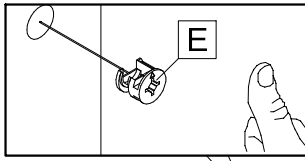

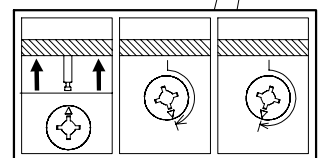
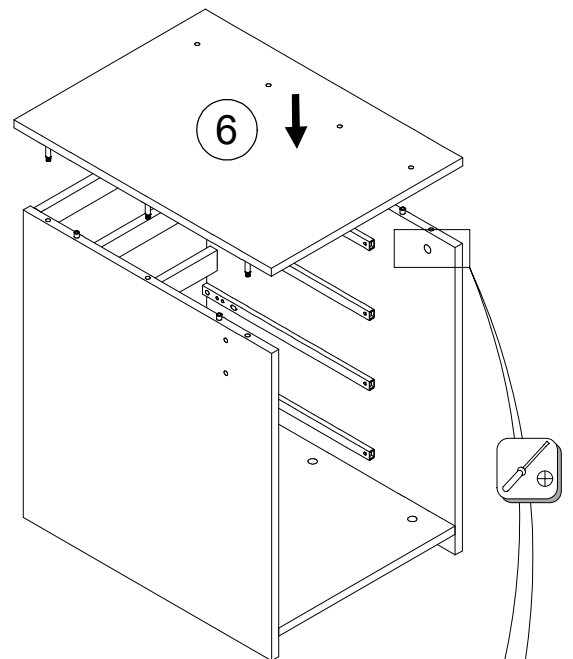
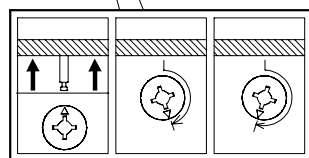
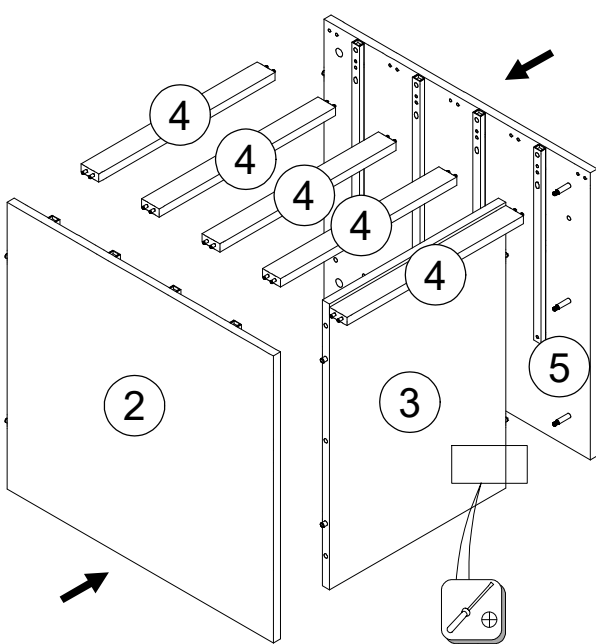
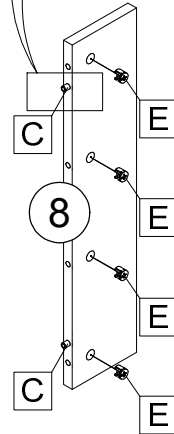

	$\varnothing 8 \times 30$				$\varnothing 5 \times 30$
C	2x	E	6x	K	20x

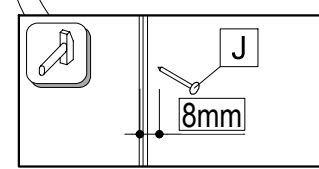
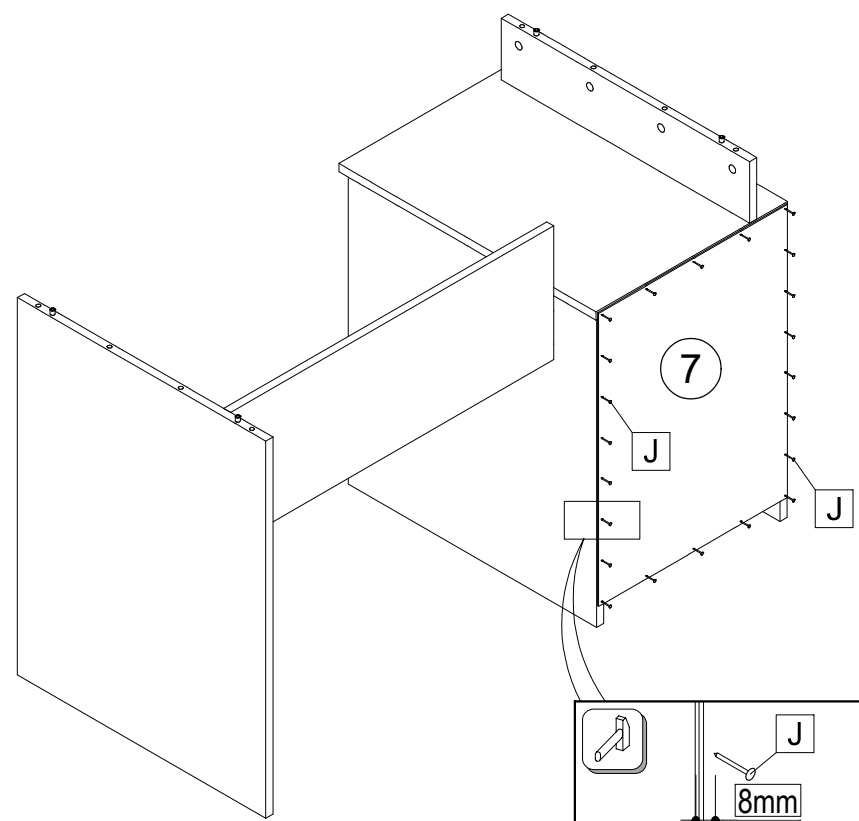
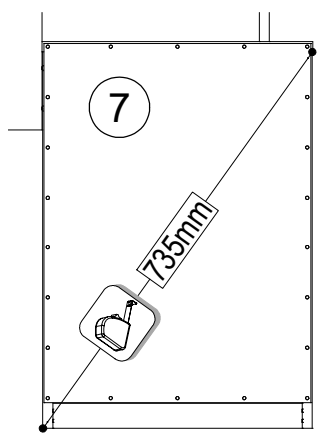
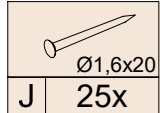
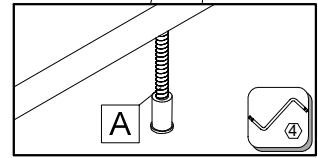
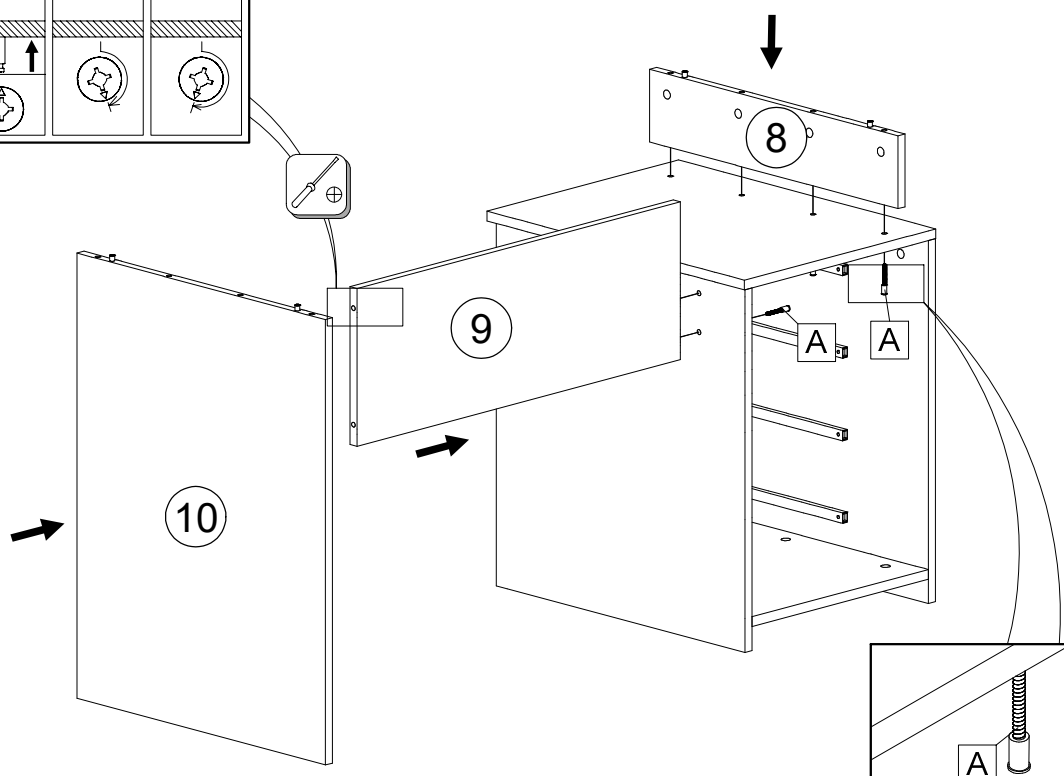
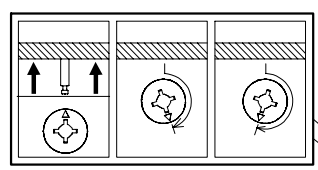
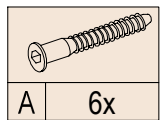

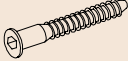
**5x**





											
A	8x	C	16x	D	8x	E	8x	G	8x	N	44x

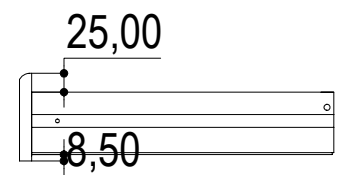
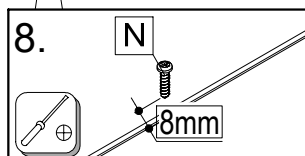
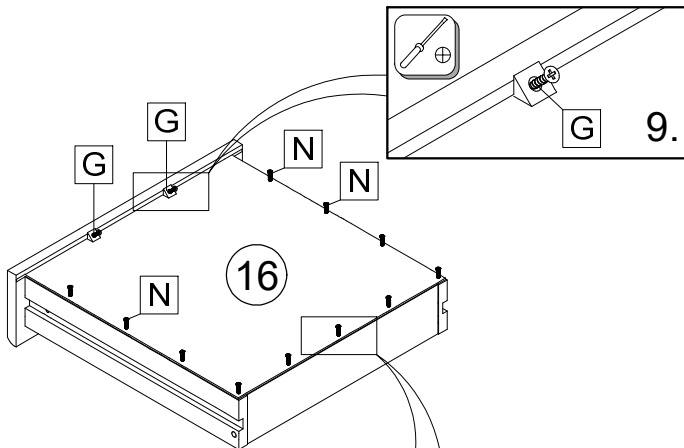
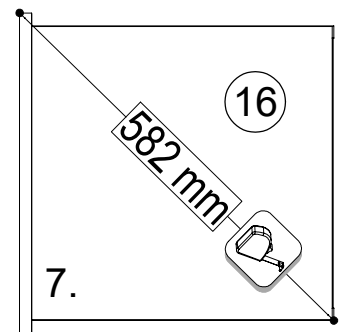
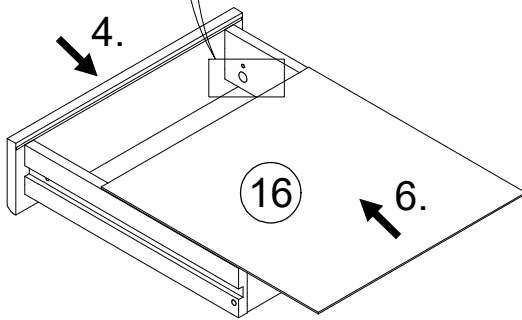
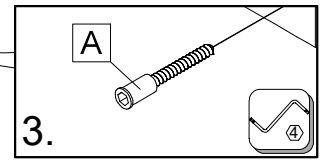
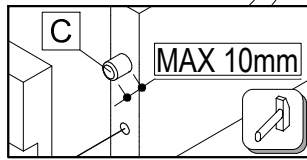
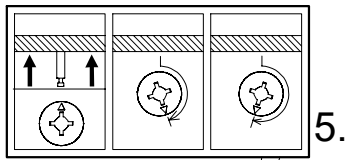
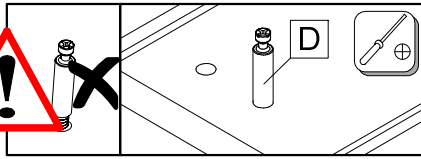
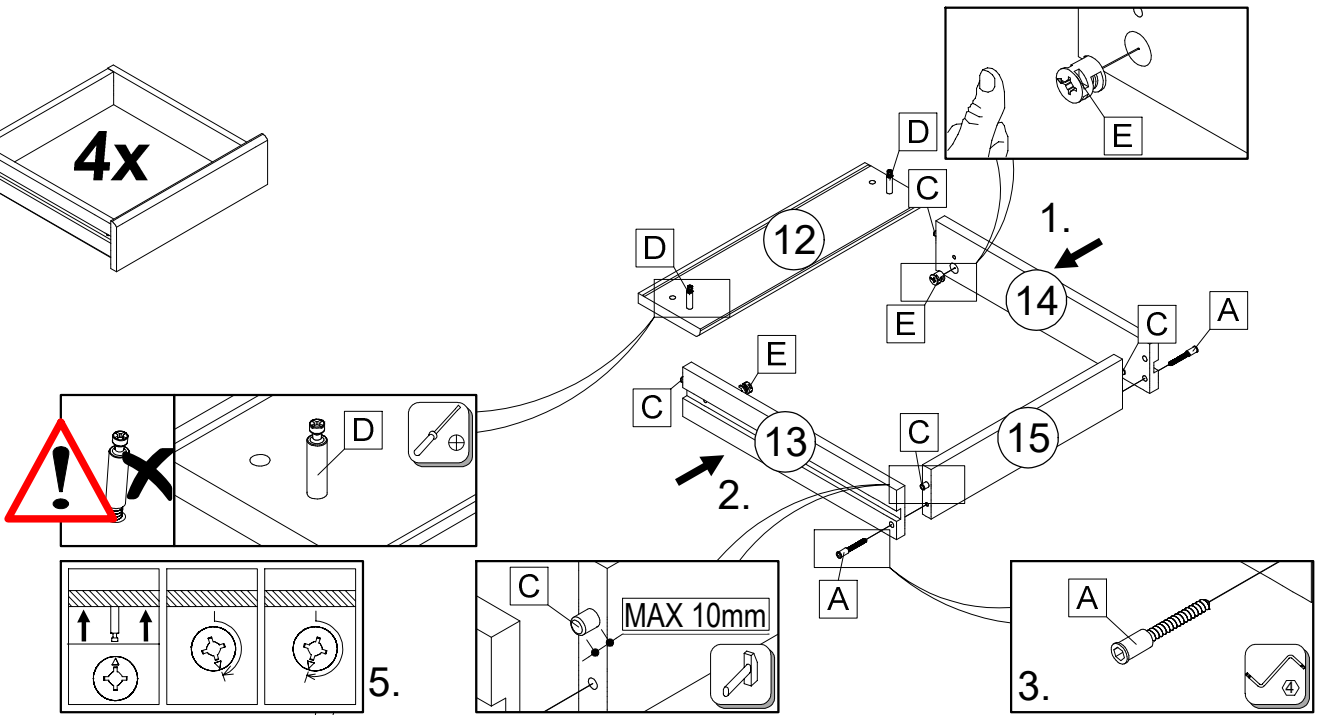
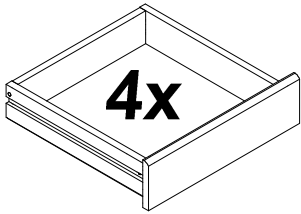

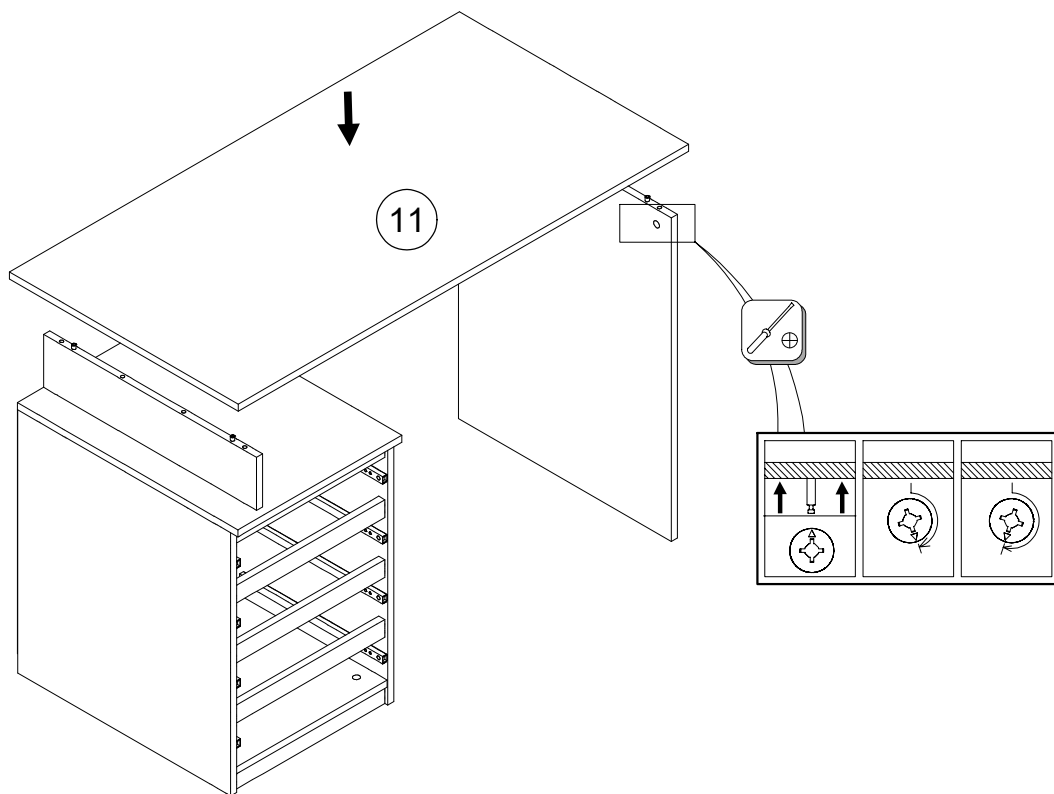

	M4x12
B	8x

