















MULTINA

<p>Ax2</p> 	<p>Bx4</p> 	<p>Cx2</p> 	
<p>Dx1</p> 	<p>Ex1</p> 	<p>Fx2</p> 	<p>Gx2</p> 
<p>Hx2</p> 	<p>Ix2</p> 	<p>Jx1</p> 	<p>Kx1</p> 
<p>Lx1</p> 	<p>Nx4</p> 		
<p>①</p>		<p>②</p>	
<p>③</p>		<p>④</p>	

5

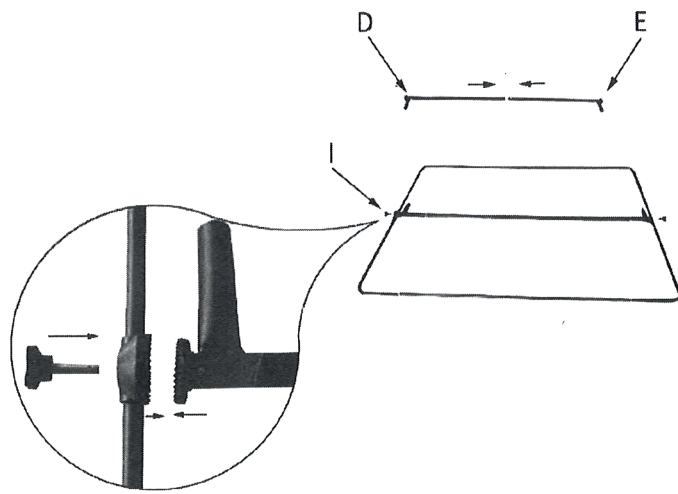

6

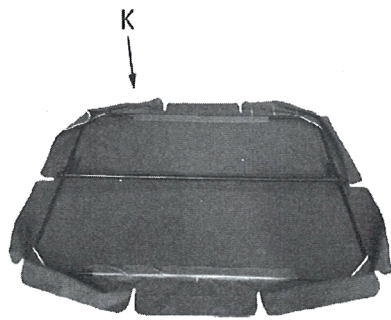

7

