

ASISTENT AS-034-z0

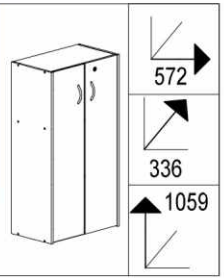

22300,00	22243,00	21102,00	27000,00	32003,04		36001,01	36001,01	35101,01	34197,01
A 12x	B 12x	C 25x	D 12x	E 2x	F 12x	G 6x	H 6x	J 4x	K 1x

30201,00	22223,02	22246,00	34197,01
L 3x	M 4x	N 2x	P 1x

0h 50min		4	5,5 x 125	≤ 0,5 kg	0,6m	3m	

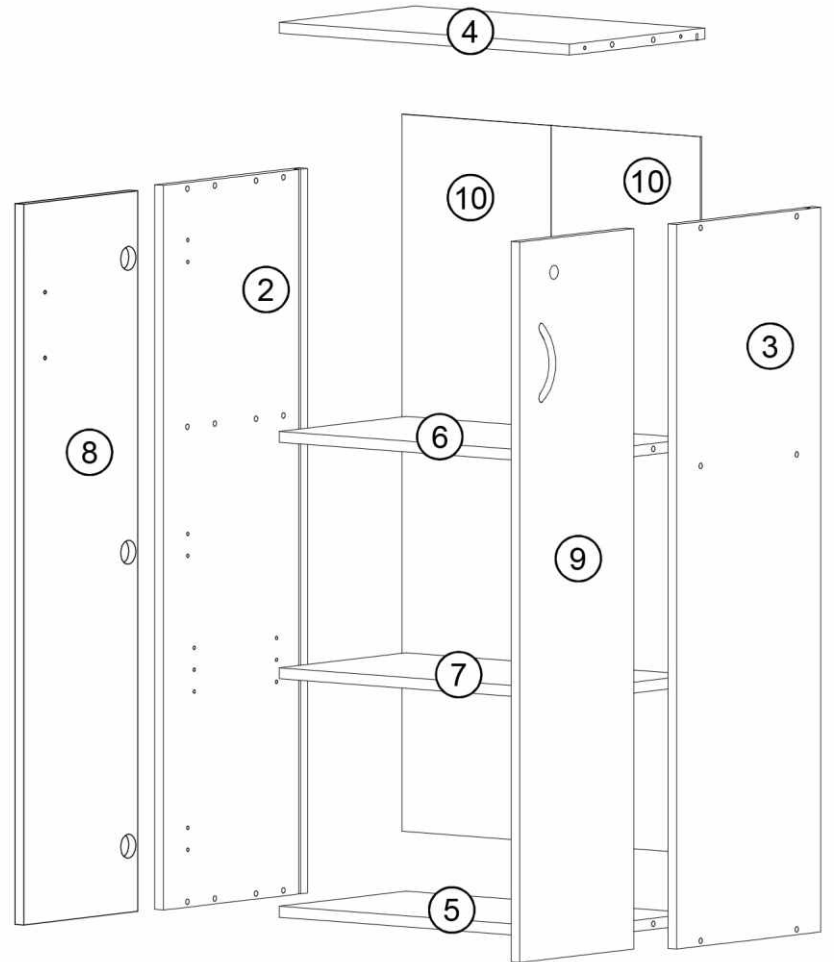

ID	ID	ID	ID	ID
00160	②	1059*336*16	1x	1/1
00161	③	1059*336*16	1x	1/1
00029	④	540*316*16	1x	1/1
00004	⑤	540*296*16	1x	1/1
00007	⑥	540*296*16	1x	1/1
00005	⑦	540*296*16	1x	1/1
00165	⑧	1053*265*16	1x	1/1
00166	⑨	1053*265*16	1x	1/1
00162	⑩	1048*278*2,5	2x	1/1

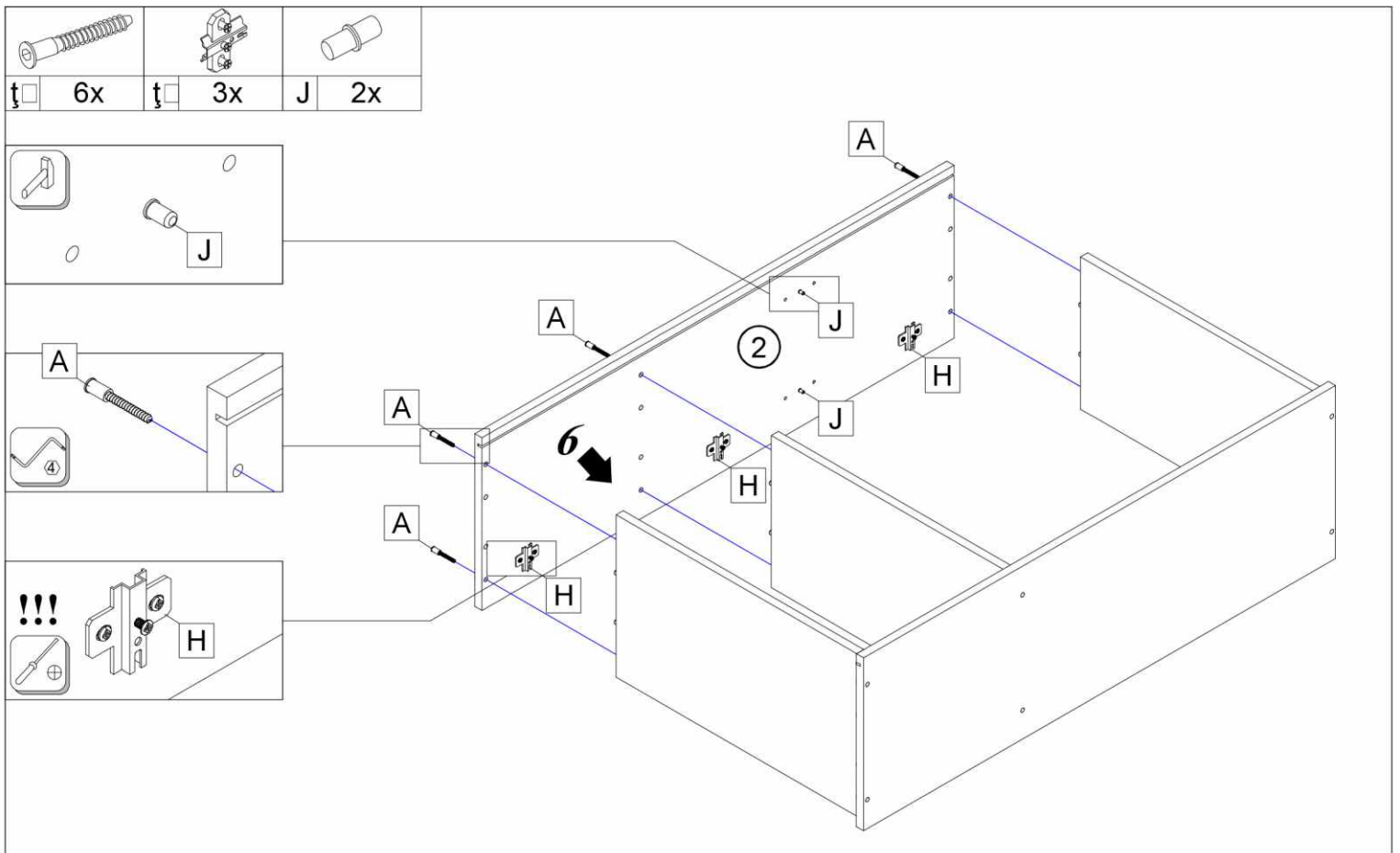
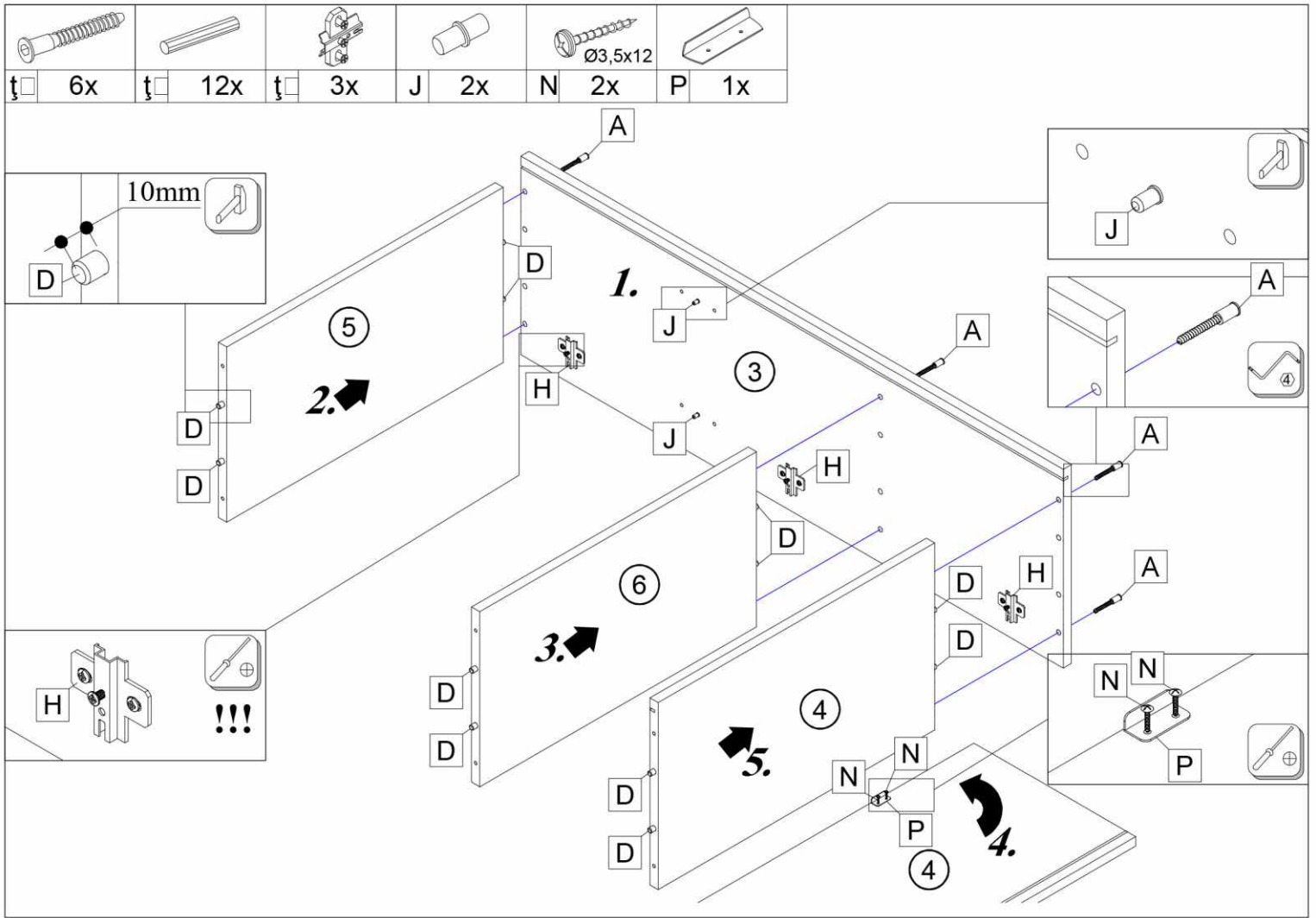

✓	✗	✗	✗	✗	✗
!	✓	✓	✓	✓	✗
	CLEAN				

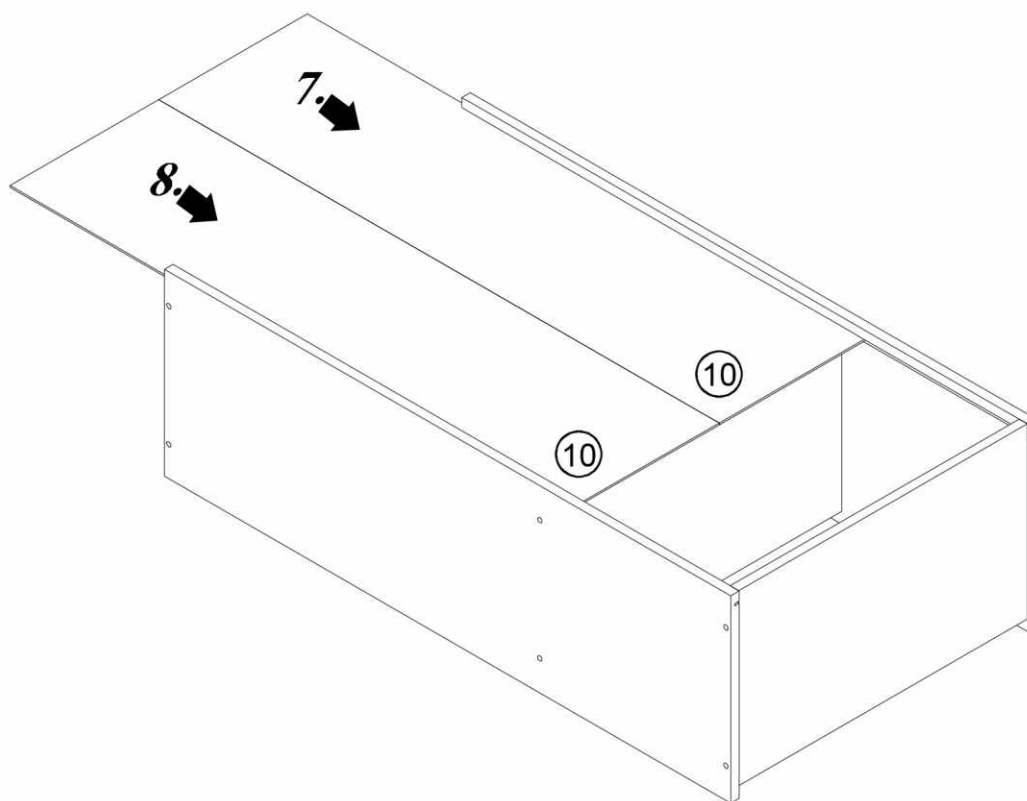



	$\varnothing 1,6 \times 20$	
C	24x	F
		12x

