

30,40 G-72 1F

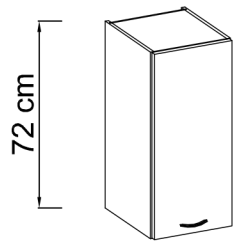

											
A	B	C	D	E	F	G	I	J	K	L	M
8	8	1	1	2	8-10	8	2	2	4	2	4

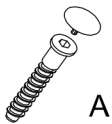
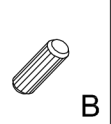
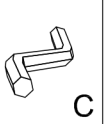
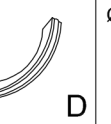
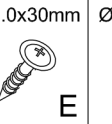
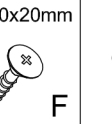
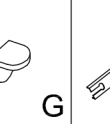
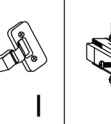
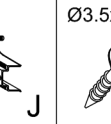
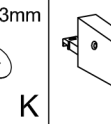
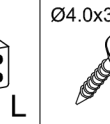
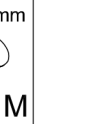
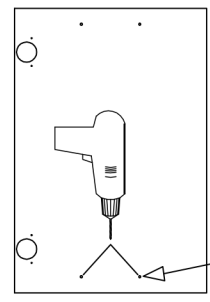
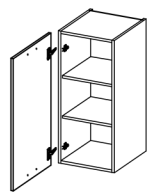
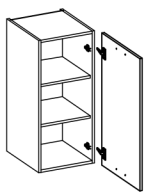
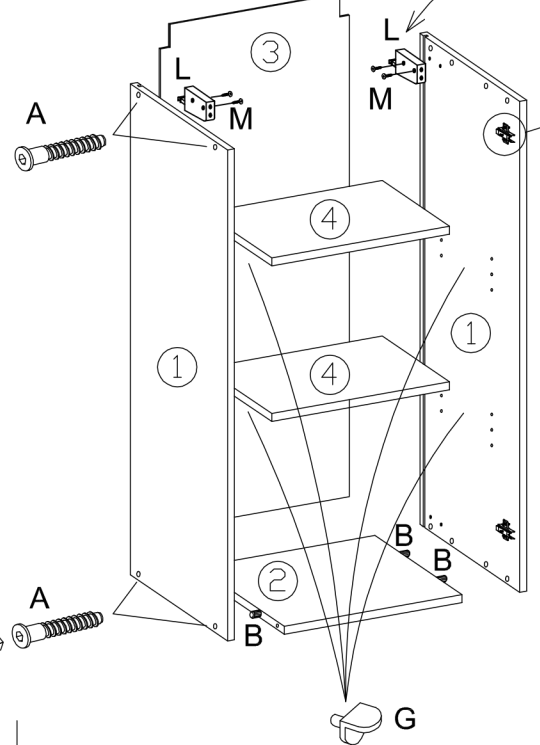
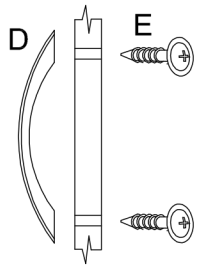
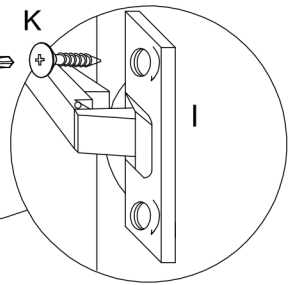
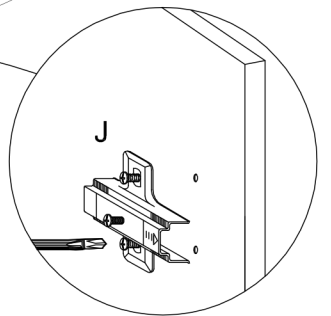
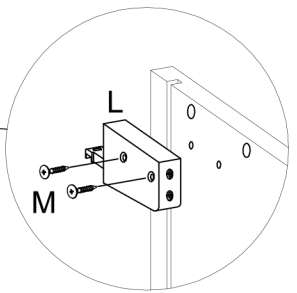
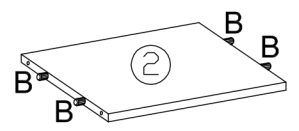
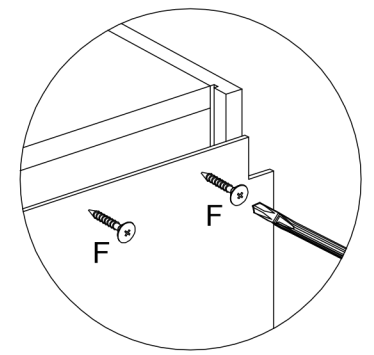

Ø5

