

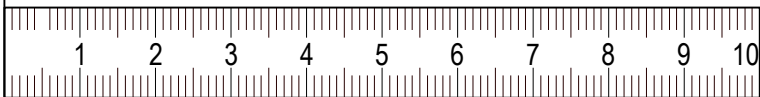

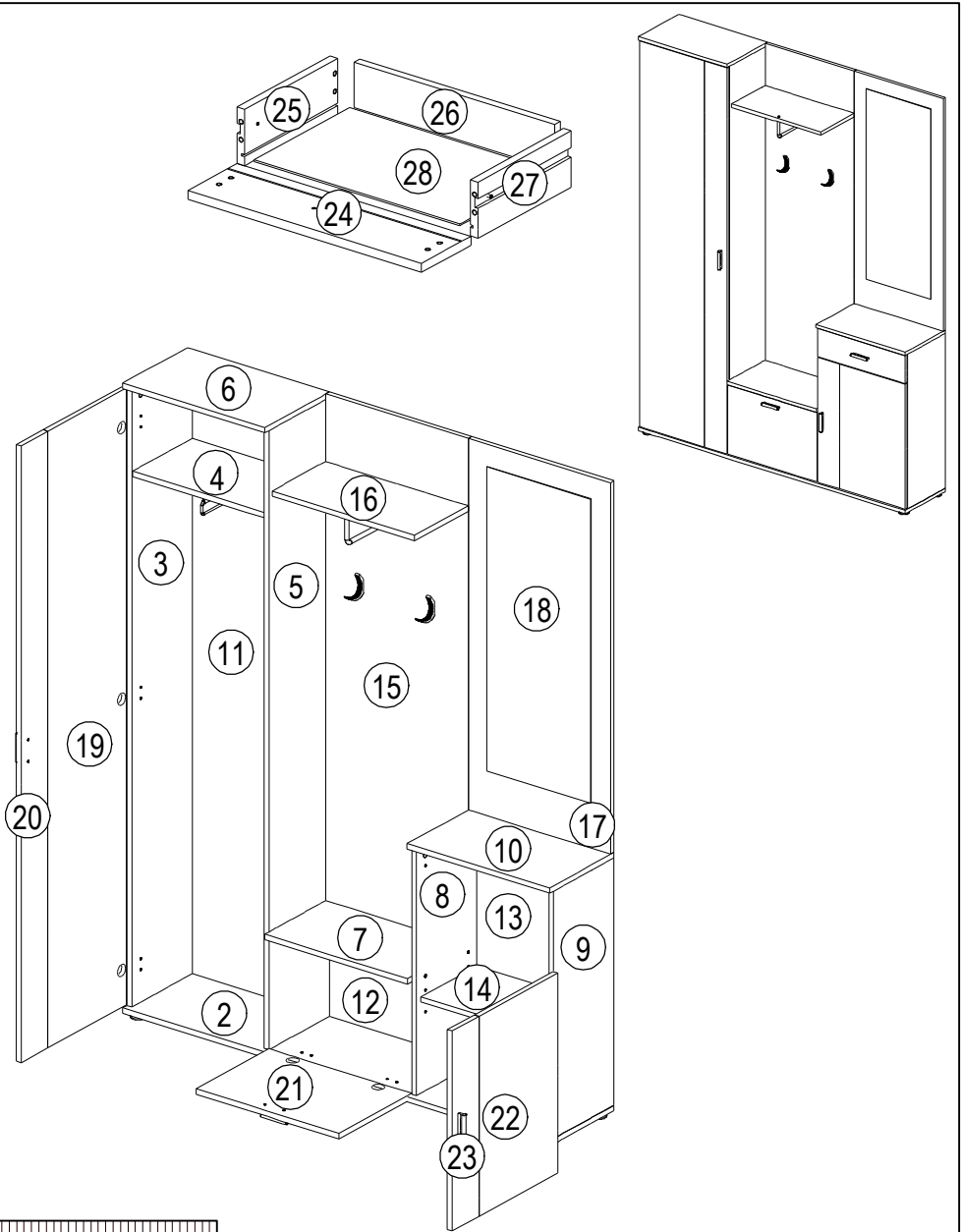



# AMALIA

	1440	mm
	1880	
	290	



ID	Image	Dimensions	Quantity	Notes
10553		1440*290*16	1x	1/2
10554		1833*270*16	1x	1/2
10555		446*268*16	1x	1/2
10556		1833*270*16	1x	1/2
10557		480*290*16	1x	1/2
10558		482*290*16	1x	1/2
10559		733*270*16	1x	1/2
10560		733*270*16	1x	1/2
10561		480*290*16	1x	1/2
10562		1858*467*2,5	1x	2/2
10563		358*498*2,5	1x	2/2
10564		758*467*2,5	1x	2/2
10565		446*250*16	1x	1/2
10566		1500*480*16	1x	2/2
10567		481*240*16	1x	2/2
10568		1100*480*16	1x	2/2
10569		900*350*3	1x	2/2
10570		1826*352*16	1x	2/2
10571		1826*120*16	1x	2/2
10572		327*482*16	1x	2/2
10573		592*352*16	1x	2/2
10574		592*120*16	1x	2/2
10575		472*132*16	1x	2/2
10579		250*100*16	1x	1/2
10576		406*80*16	1x	1/2
10577		250*100*16	1x	1/2
10578		256*416*2,5	1x	2/2

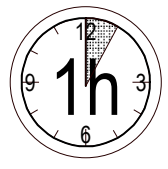
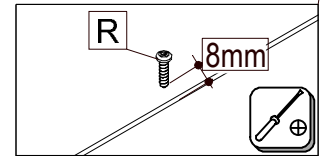
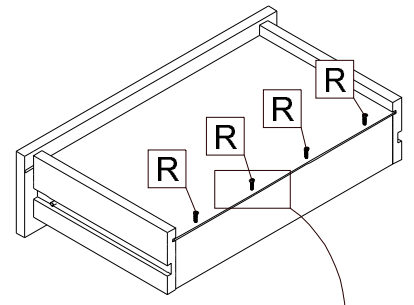
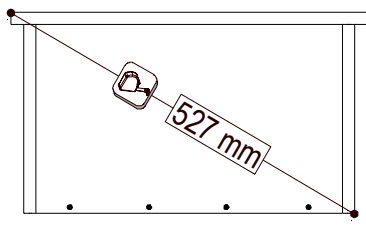
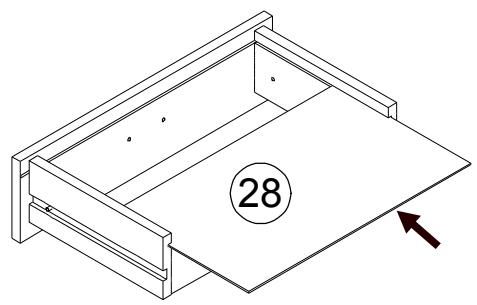
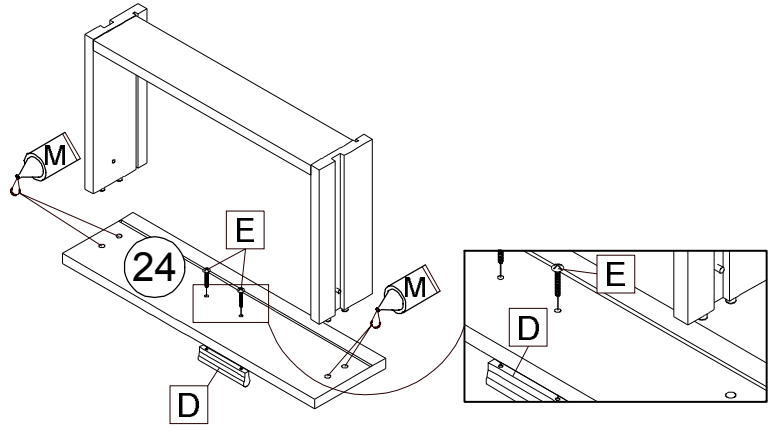
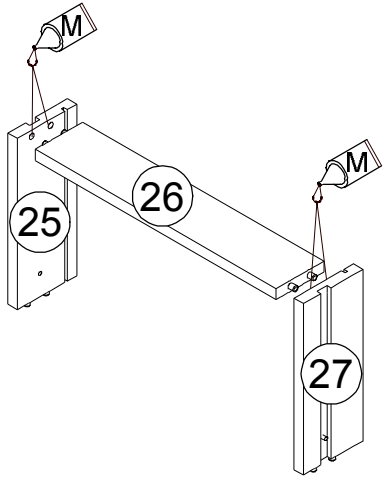
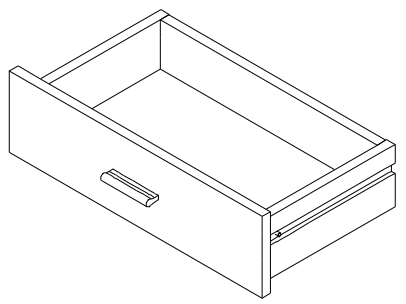
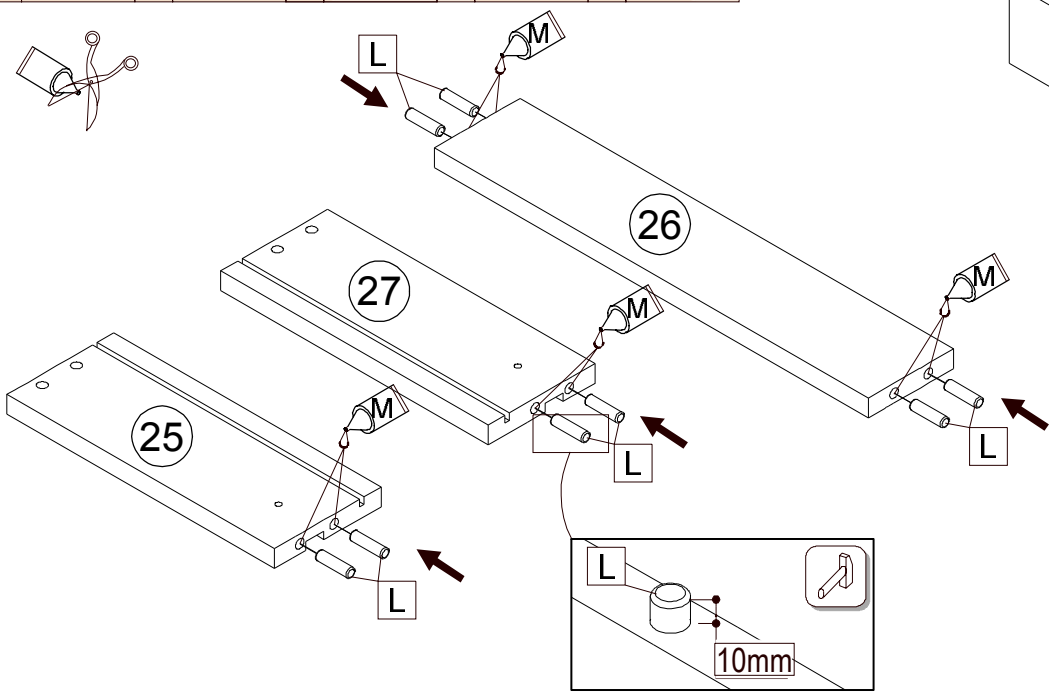

22250,00  Ø4x25	21102,00  Ø1,2x20	31103,00 	32314,01 	22501,02  M4x20	36002,07 	36002,07 	27001,00  Ø8x40	70013,01 	70021,01 
A 6x	B 75x	C 1x	D 4x	E 14x	F 5x	F1 5x	G 11x	H 12x	J 12x
22243,00  Ø3,5x15	27000,00  Ø8x30	70889,00 	22300,00  Ø7x50	22502,00  M4x12	22705,00  Ø6,3x8	22244,01  Ø3,5x16	35102,00 	33030,00 	35101,01 
K 26x	L 40x	M 1x	N 17x	P 2x	Q 4x	R 10x	S 1x	T 1x	U 4x
9290,00 	30080,00  Ø44x15	31025,00 	31026,00 	36001,01 	36001,01 	31003,02 			
V 3x	W 6x	X 1x	Y 2x	Z 2x	Z1 2x	Z2 1x			

				
D 1x	E 2x	L 8x	M 1x	R 4x



	
Ø8x40	
G 11x	M 1x

1.

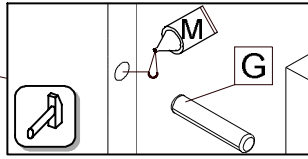

2. ↓

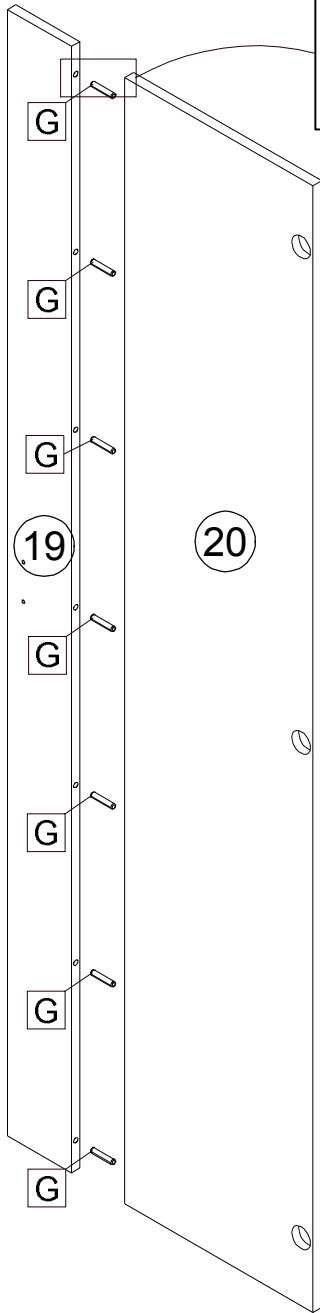

2. ←

1.

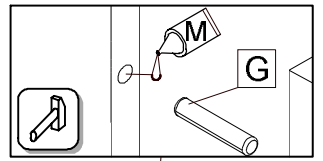



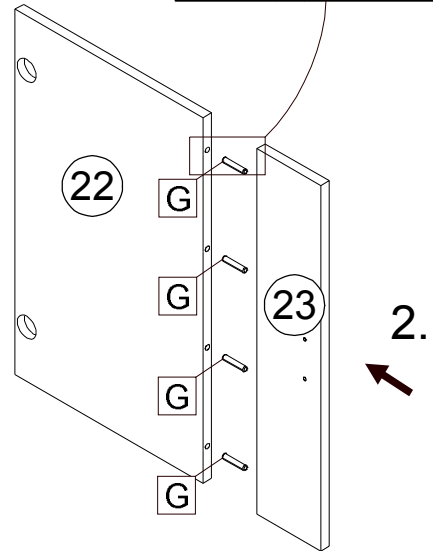



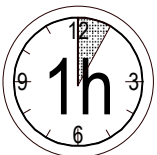
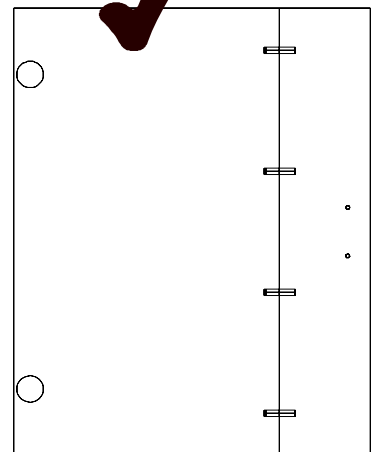
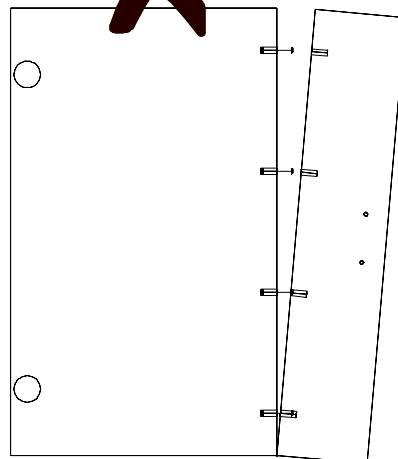





2. ↓







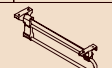

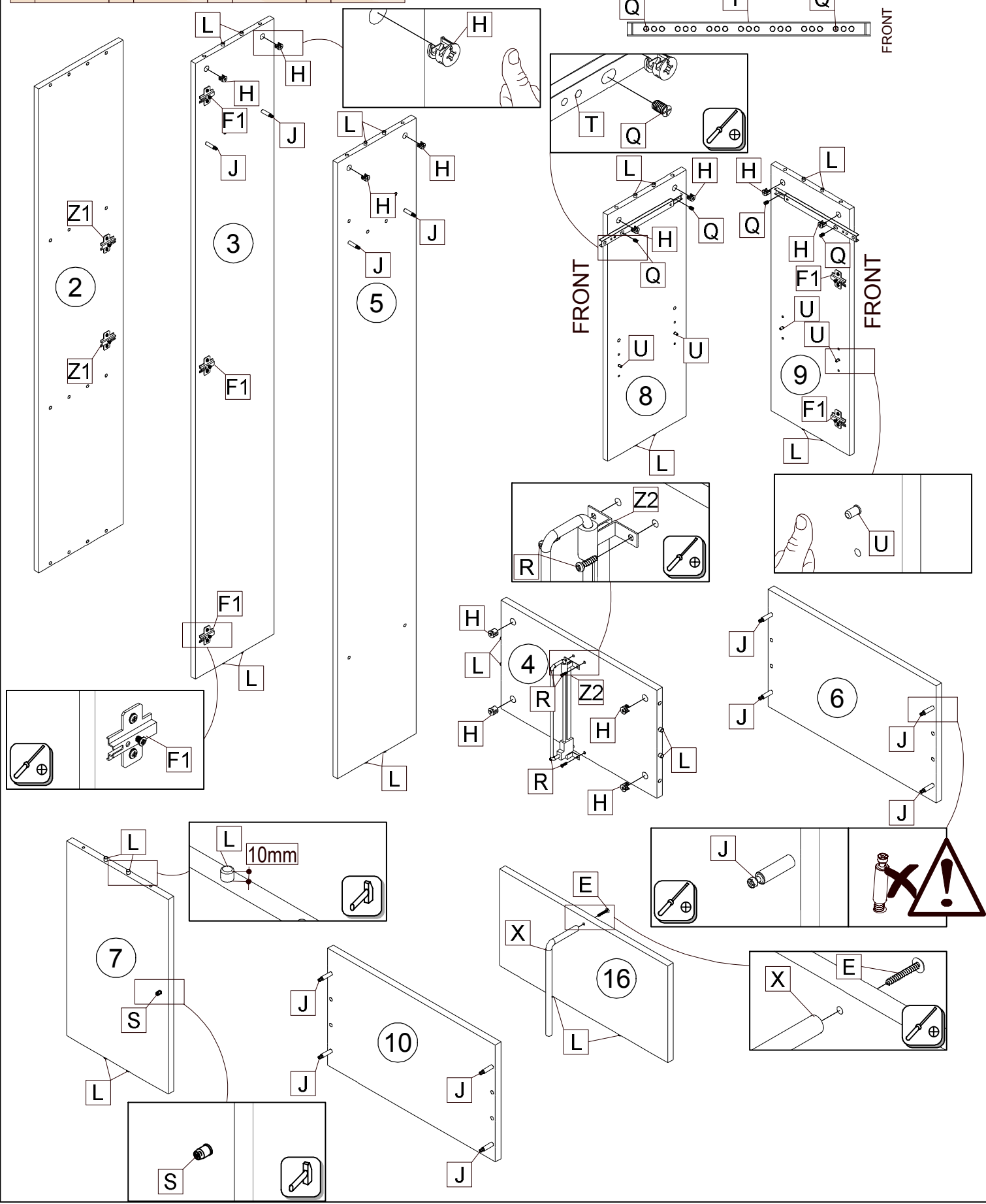
2. ←



																	
E	1x	F1	5x	H	12x	J	12x	L	26x	Q	4x	R	4x	S	1x	T	1x
																	
U	4x	X	1x	Z1	2x	Z2	1x										



						
D 3x	E 10x	F 5x	K 14x	L 6x	Y 2x	Z 2x

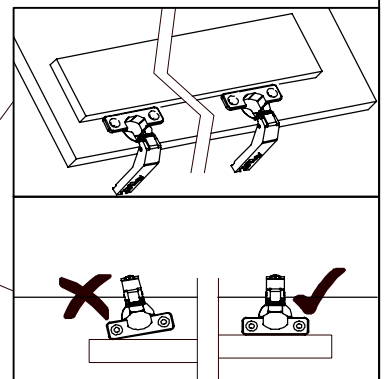
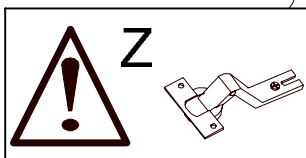
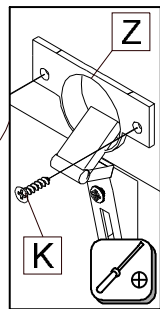
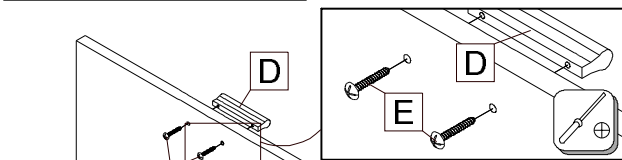
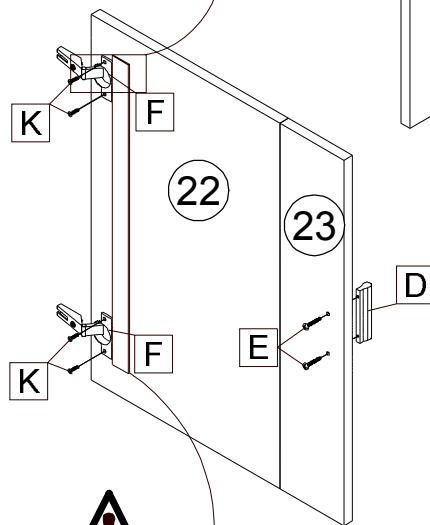
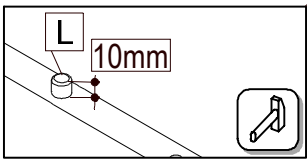
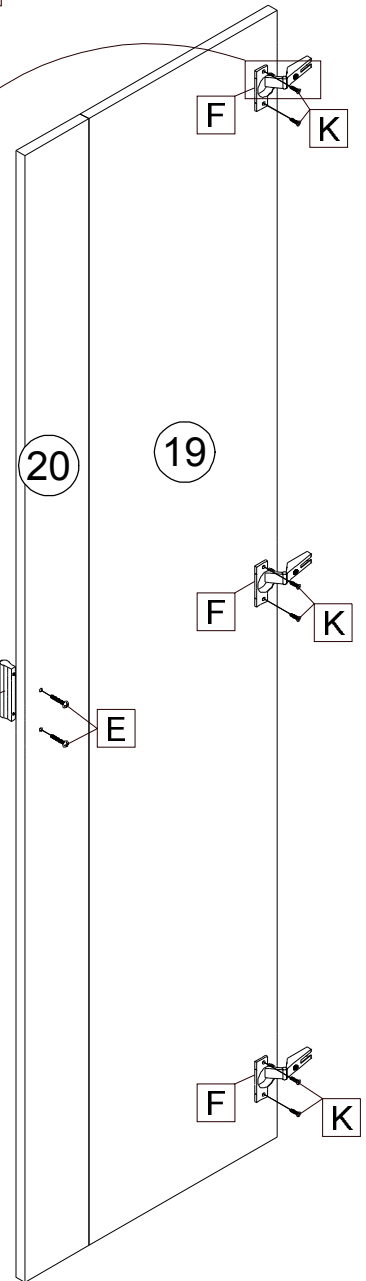
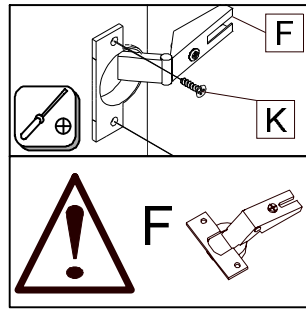
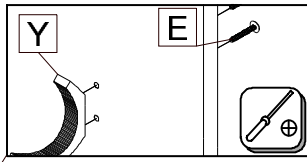
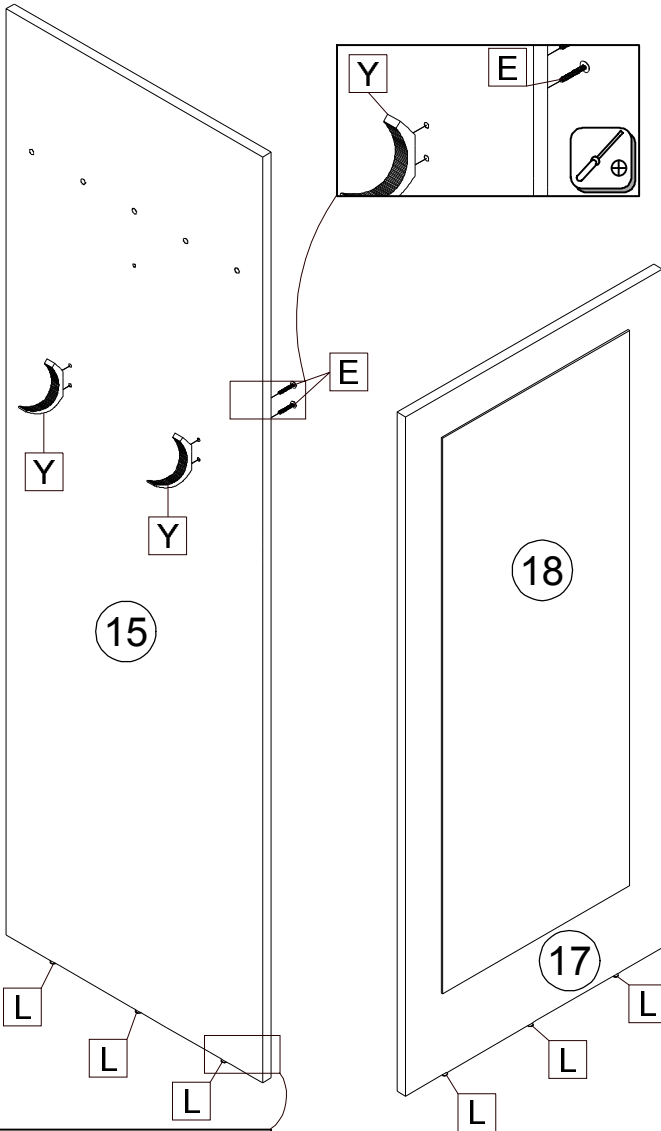

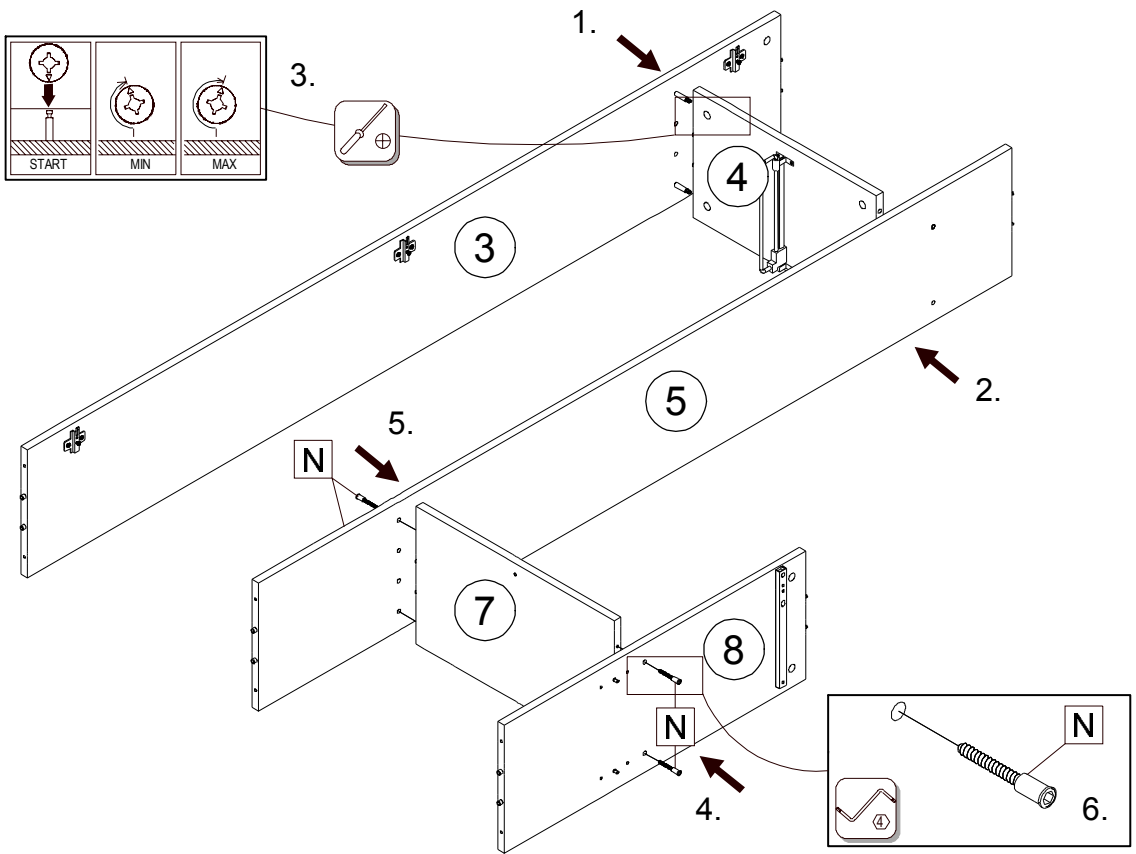

	
Ø7x50	
N	4x



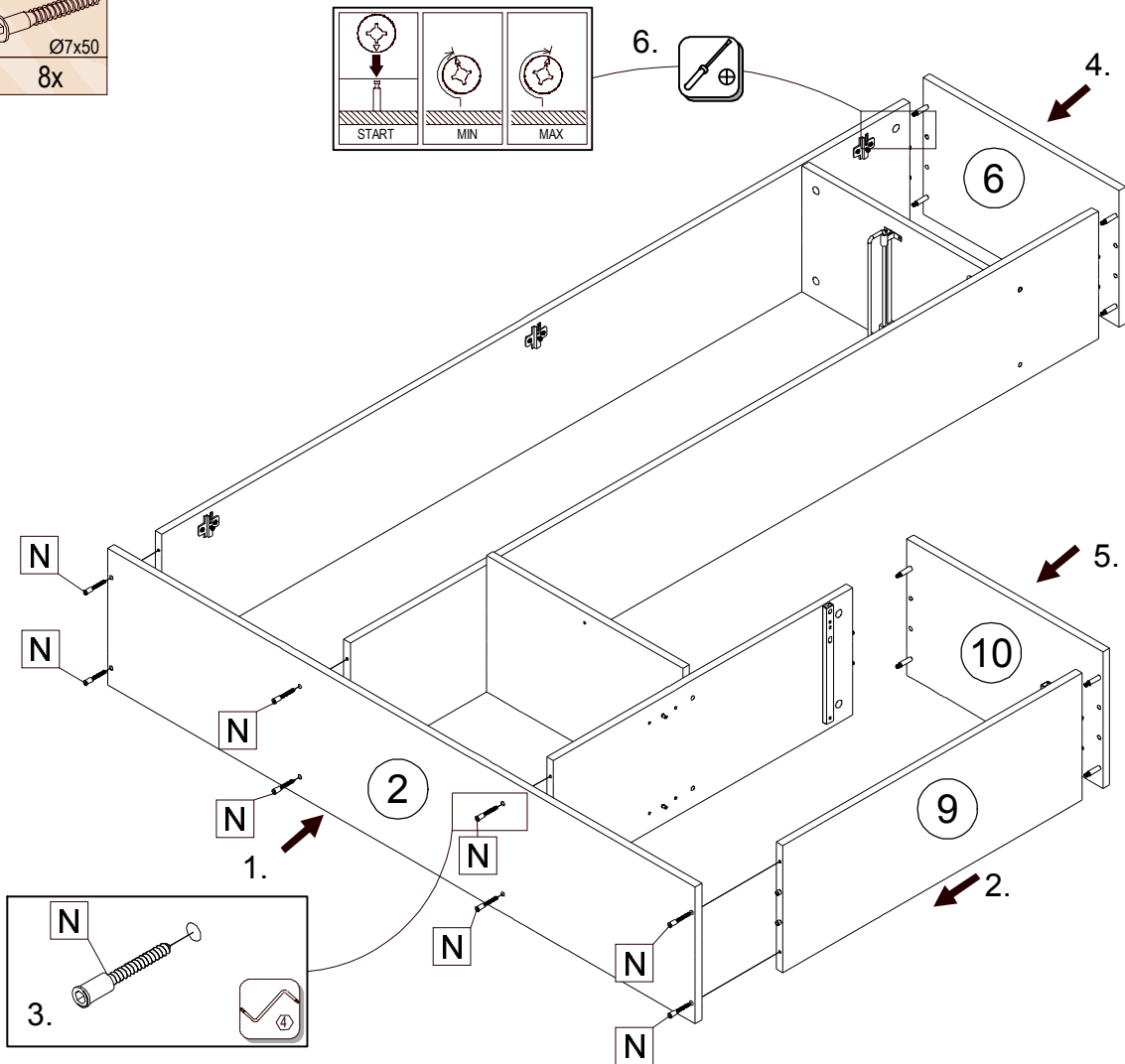

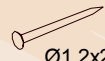
	
Ø7x50	
N	8x



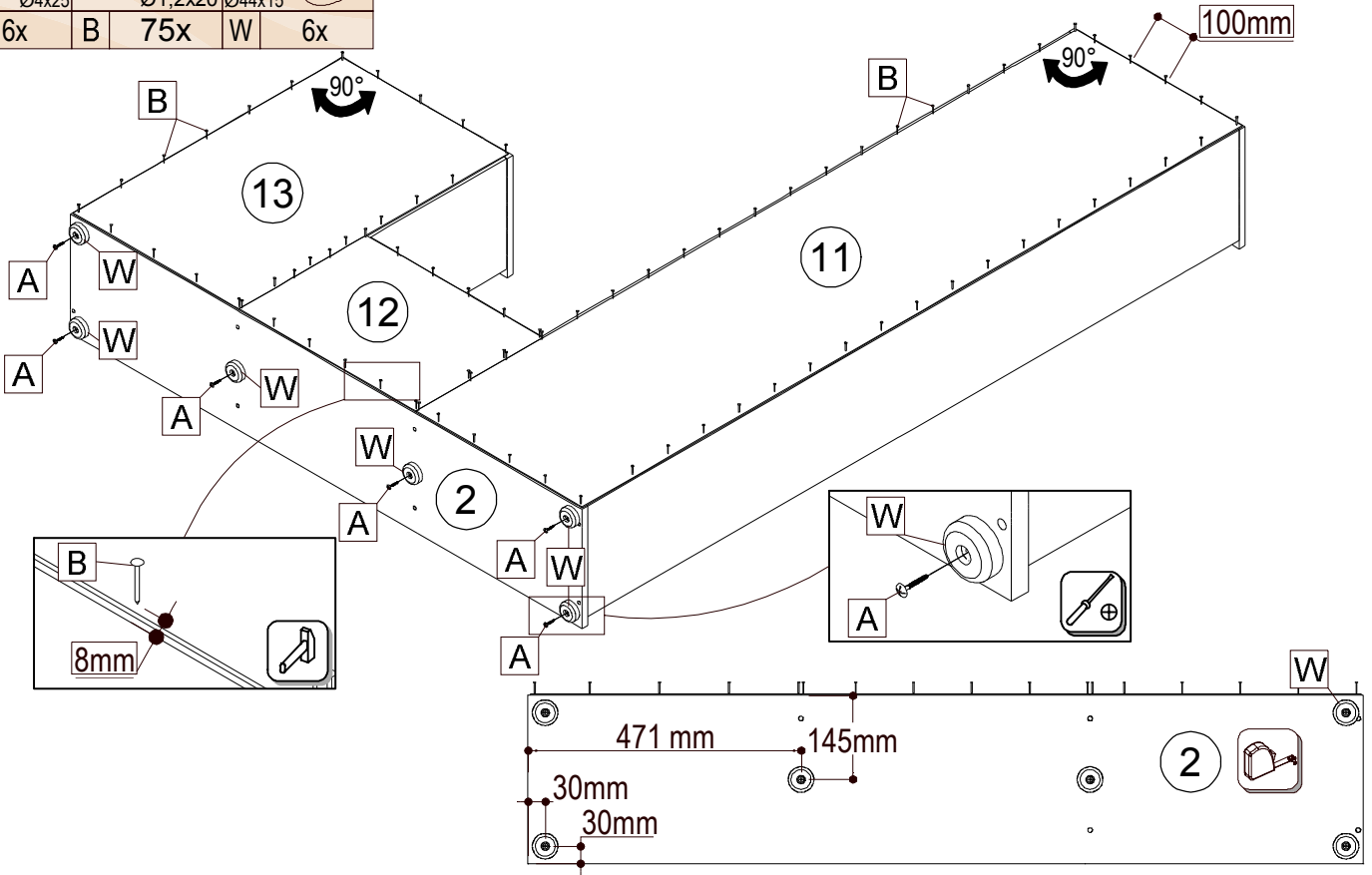

		
Ø4x25	Ø1,2x20	Ø44x15
A 6x	B 75x	W 6x



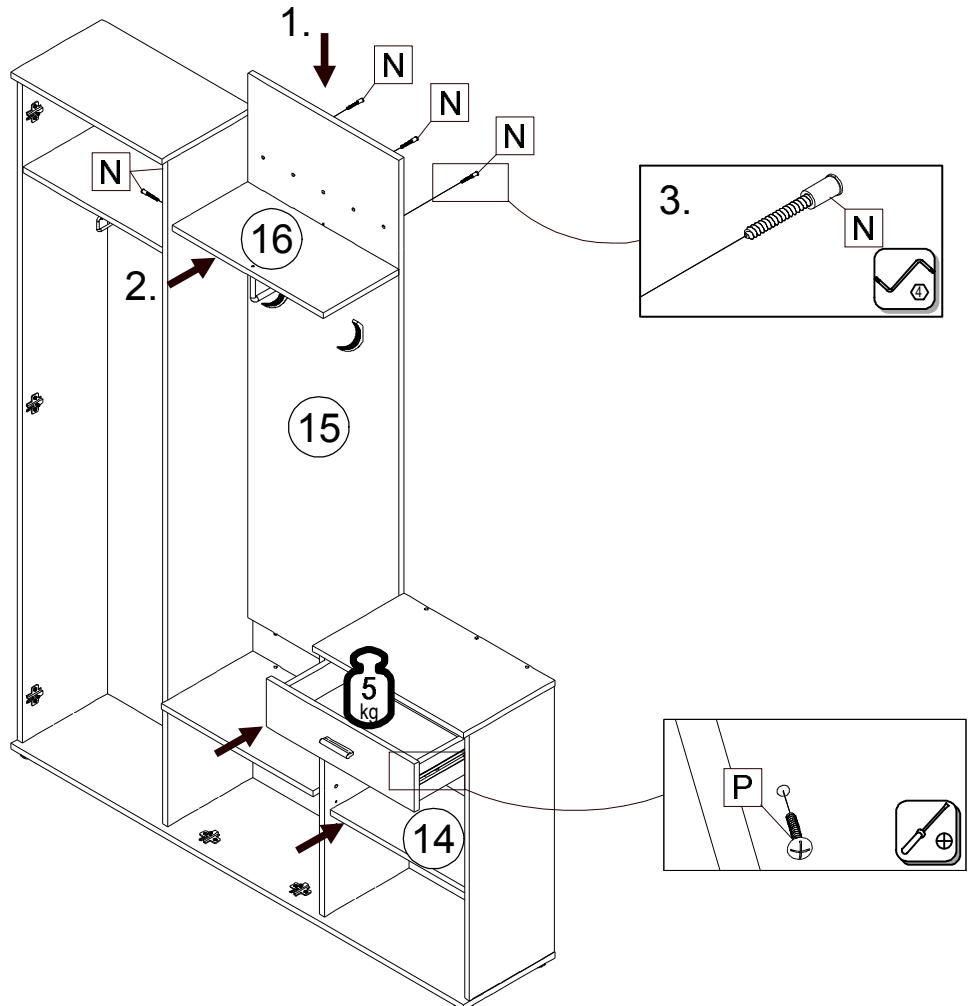

	
Ø7x50	M4x12
N 5x	P 2x

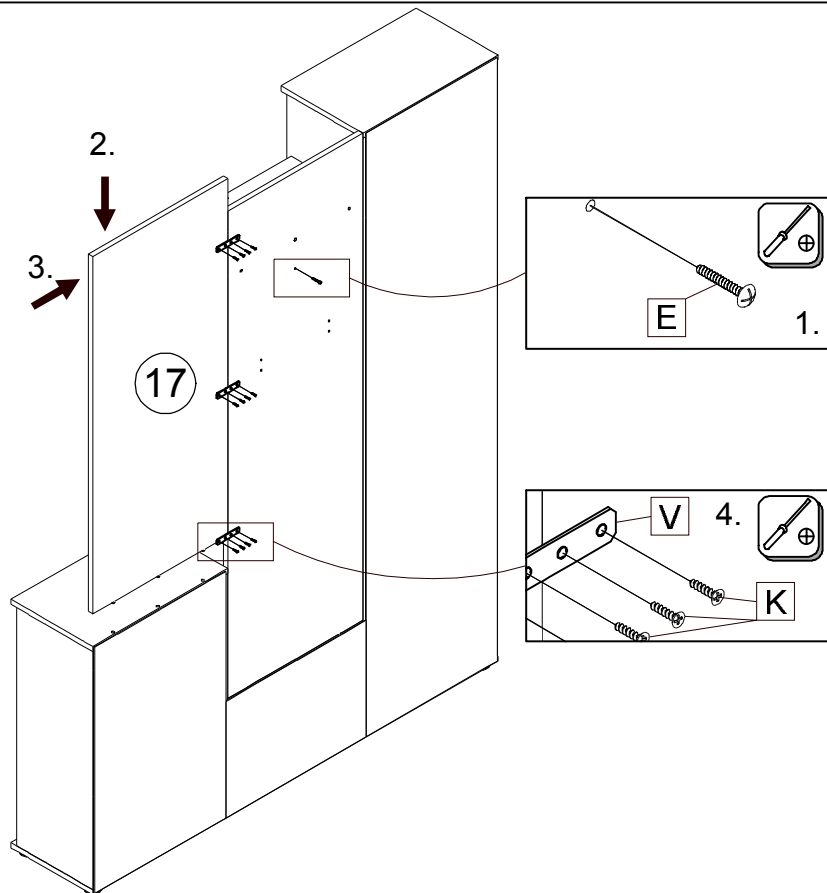

	M4x20		Ø3,5x15		
E	1x	K	12x	V	3x

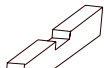

			Ø3,5x16		600 mm
C	1x	R	2x		

