

NATALI

640
1900 mm
320

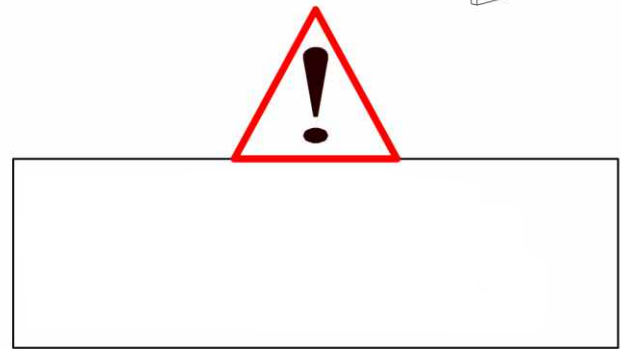

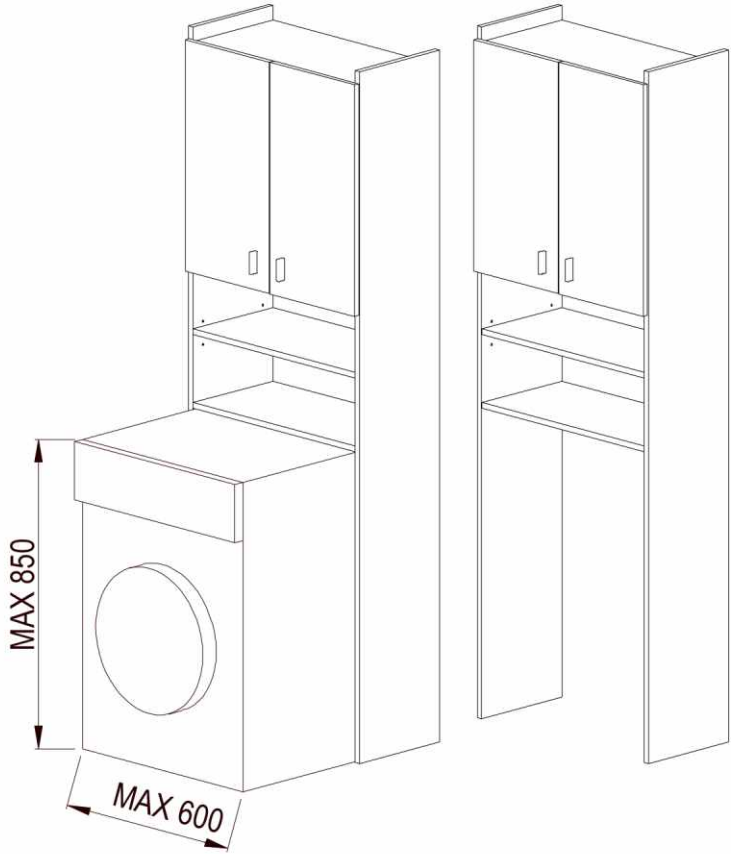
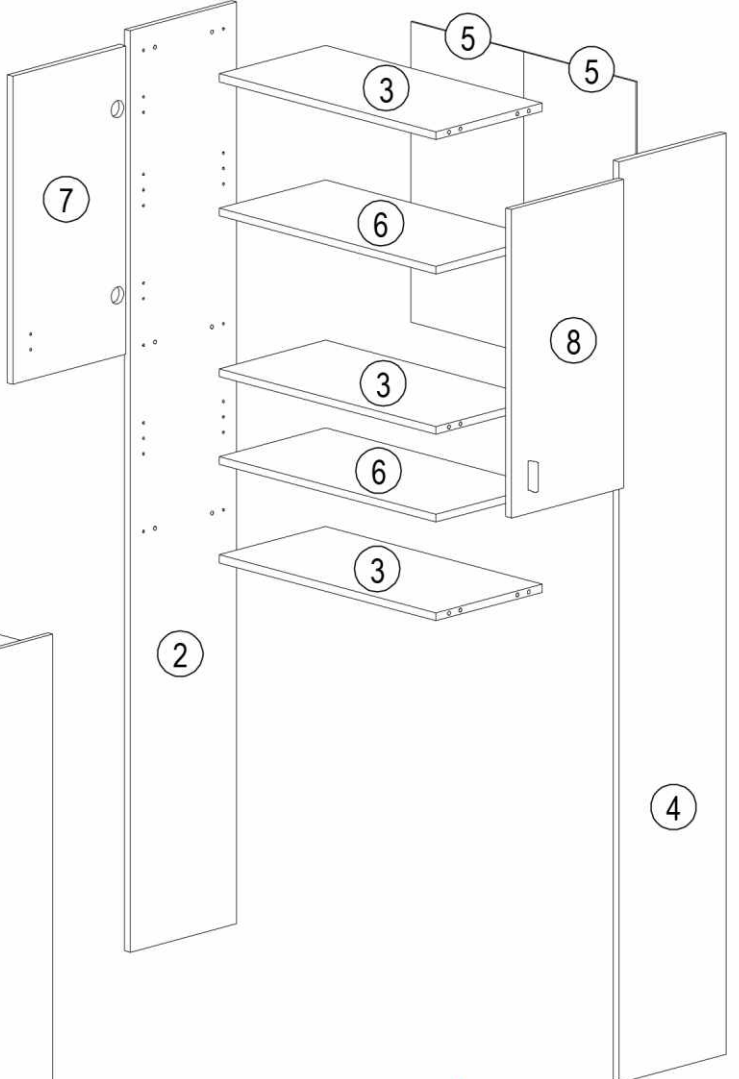

	50 min		PZ2
	3m	600 mm	

ID	ID			
12200	②	1900*300*16	1x	1/1
12201	③	608*299*16	3x	1/1
12202	④	1900*300*16	1x	1/1
12203	⑤	620*316*2,5	2x	1/1
12204	⑥	608*299*16	2x	1/1
12205	⑦	636*316*16	1x	1/1
12206	⑧	636*316*16	1x	1/1

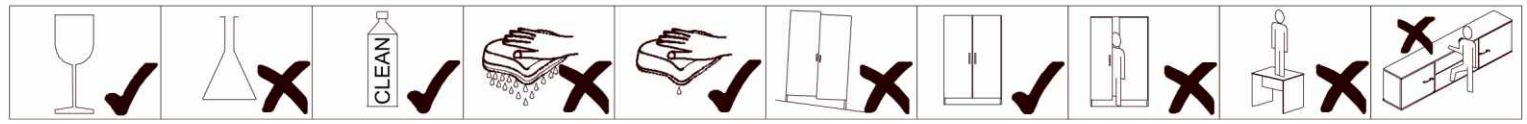





A 12x	B 8x	C 4x	D 12x	E 8x	F 12x	G 12x	H 4x	J 1x	K 2x
L 1x	M 1x	N 25x	P 4x	Q 4x	R 2x				

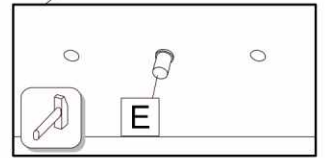
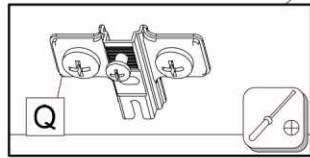
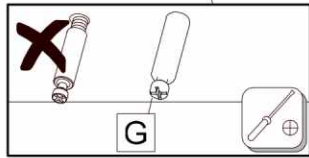
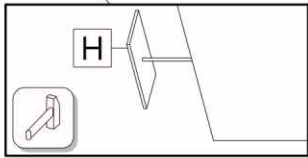
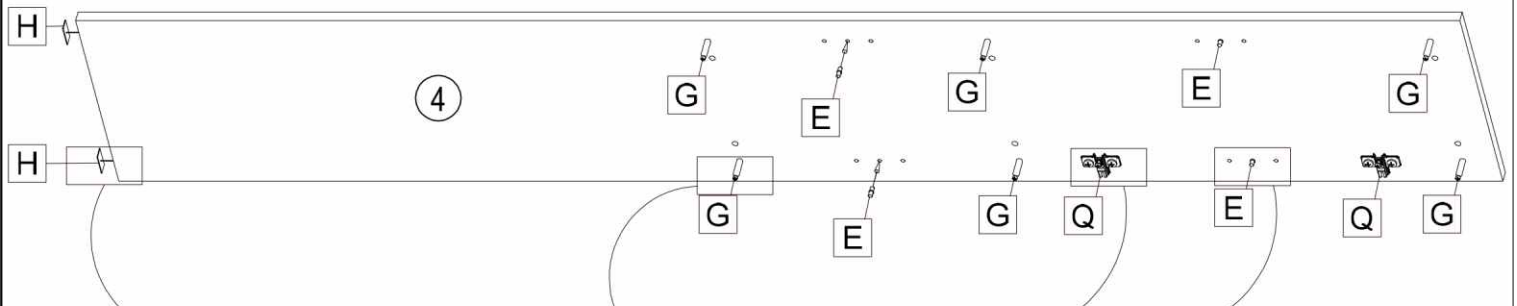
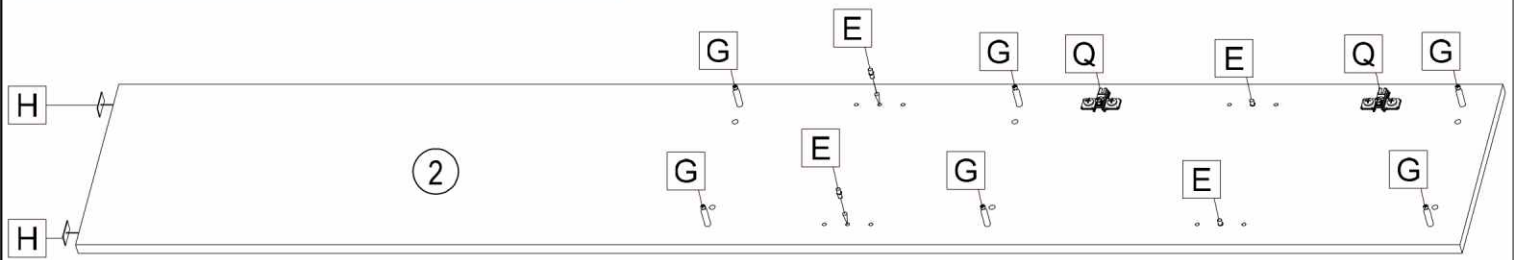

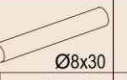
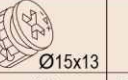
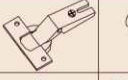

			
E 8x	G 12x	H 4x	Q 4x

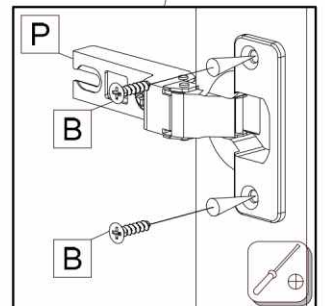
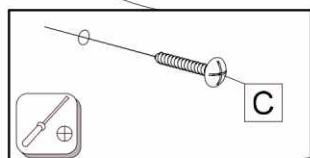
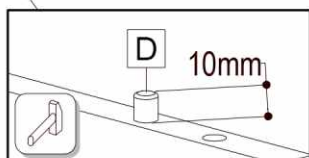
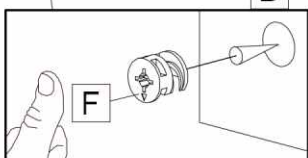
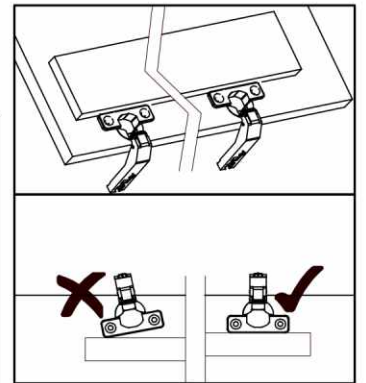
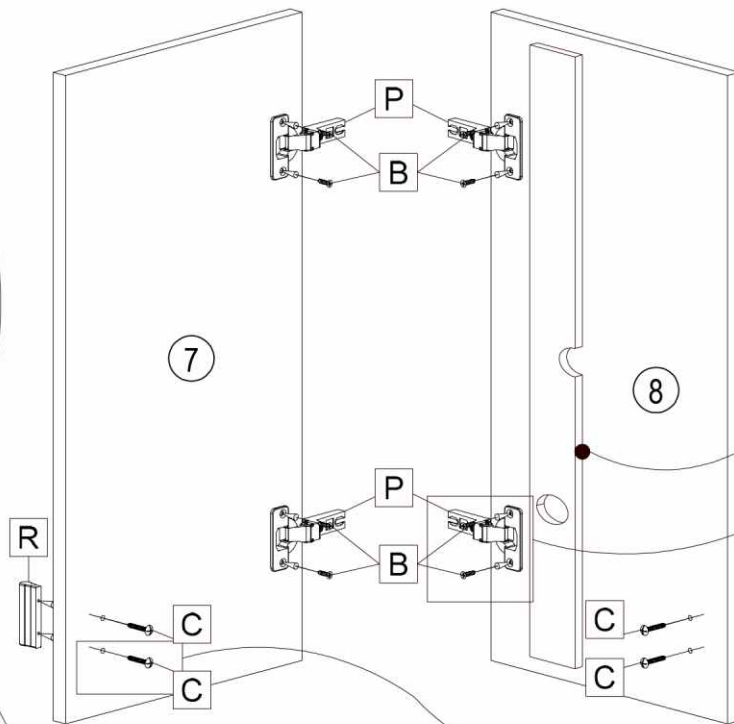
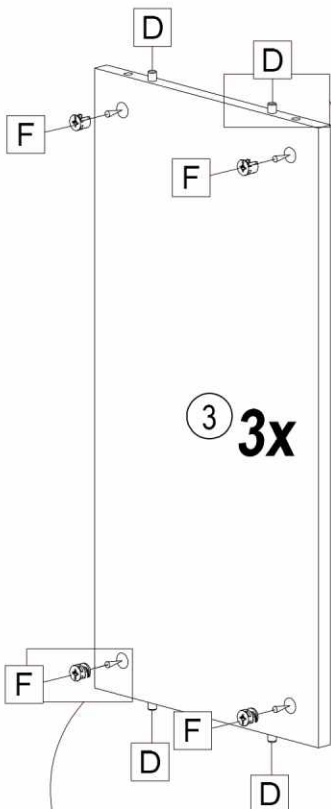
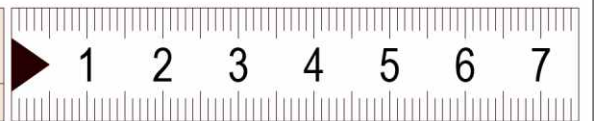

					
B 8x	C 4x	D 12x	F 12x	P 4x	R 2x

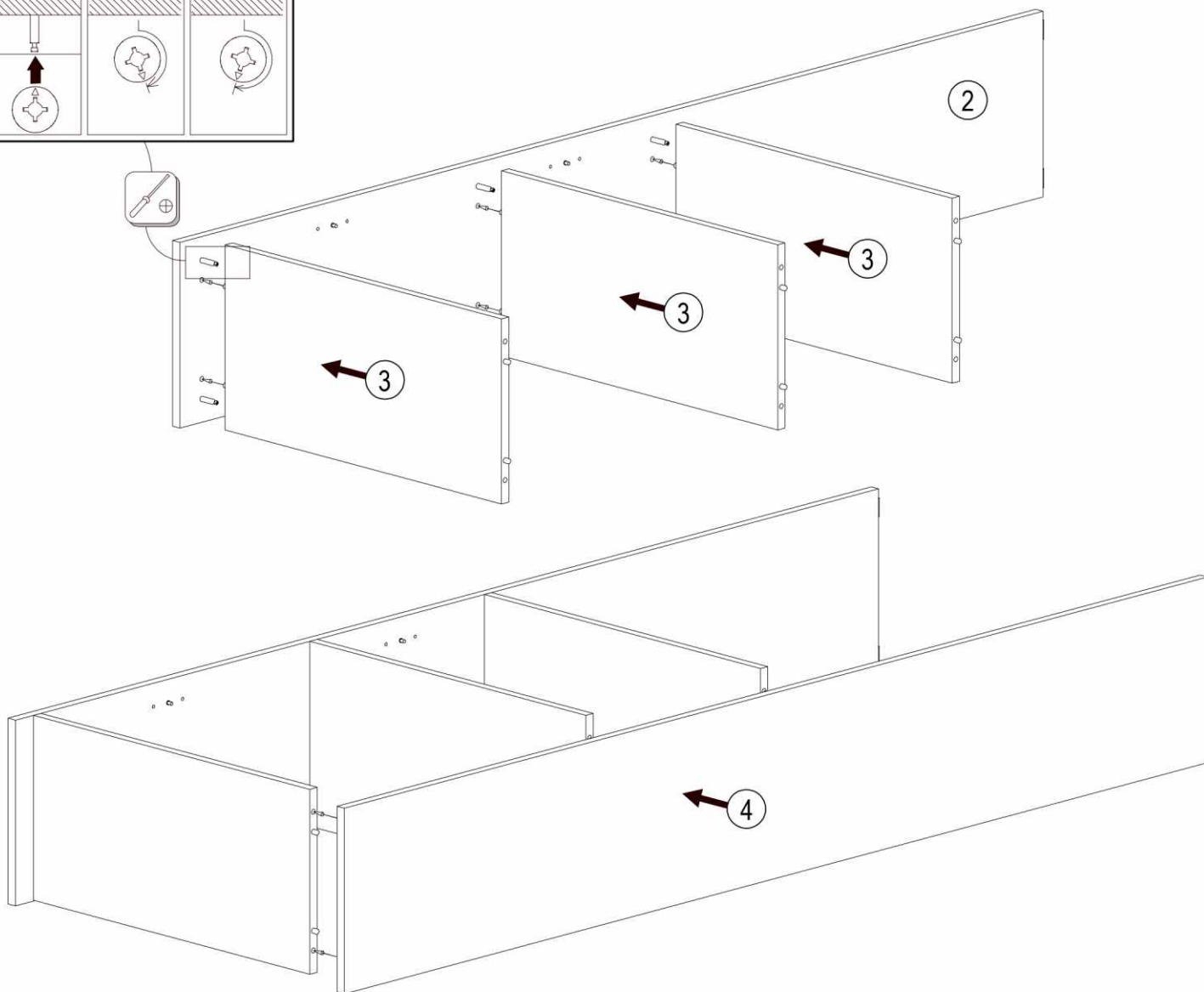
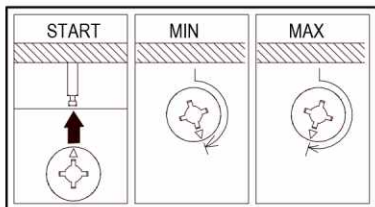



	Ø1,6x20
N	25x

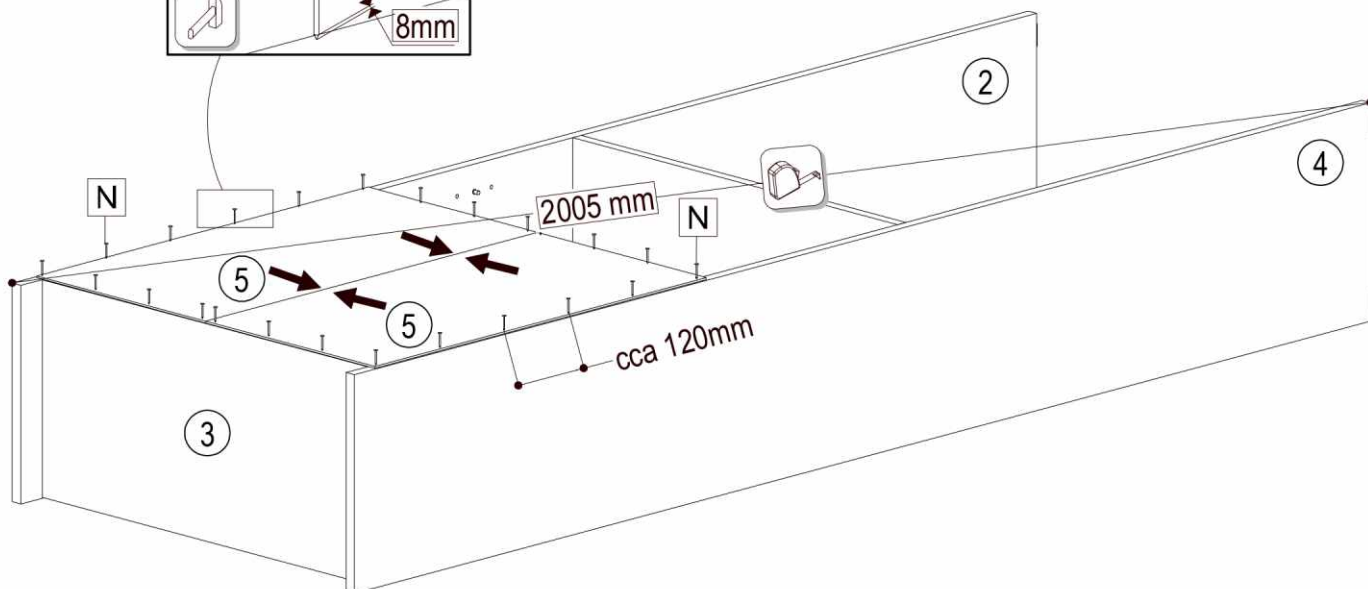
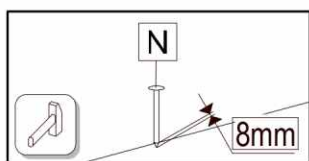

A 12x	J 1x	K 2x	L 1x	M 1x

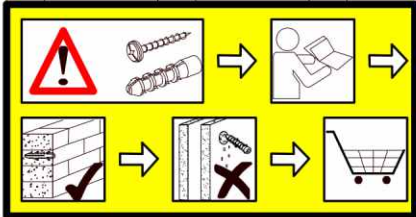

1. v=1826
2. Ø8
3. L
4. J, K
5. M

