

Zahradní domek

Návod k použití
Instrukce k sestavení domku Ares - D

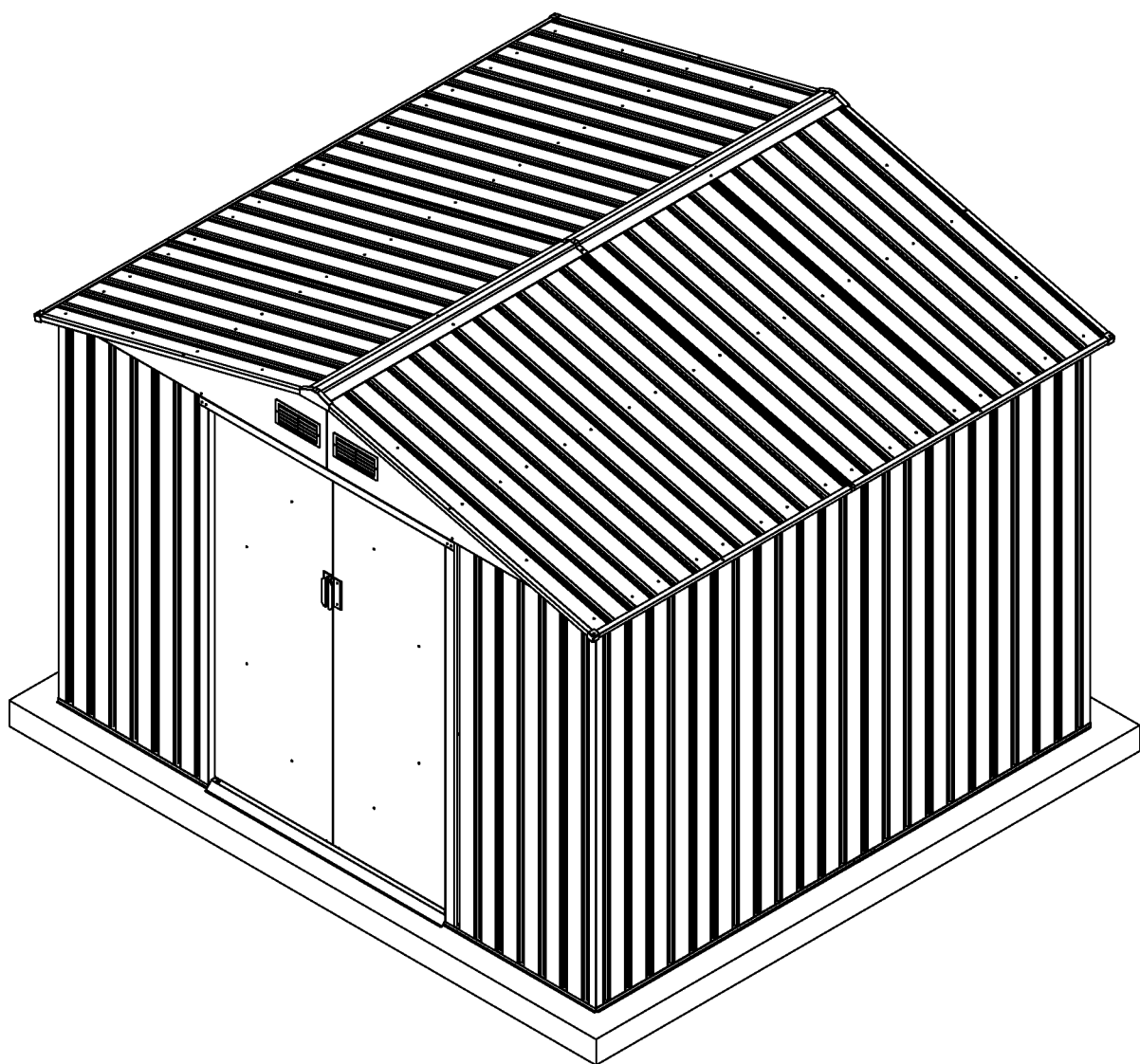

Montáž vyžaduje dva lidi a zabere cca 2-3 hodiny.

Rozměry domku Ares-D

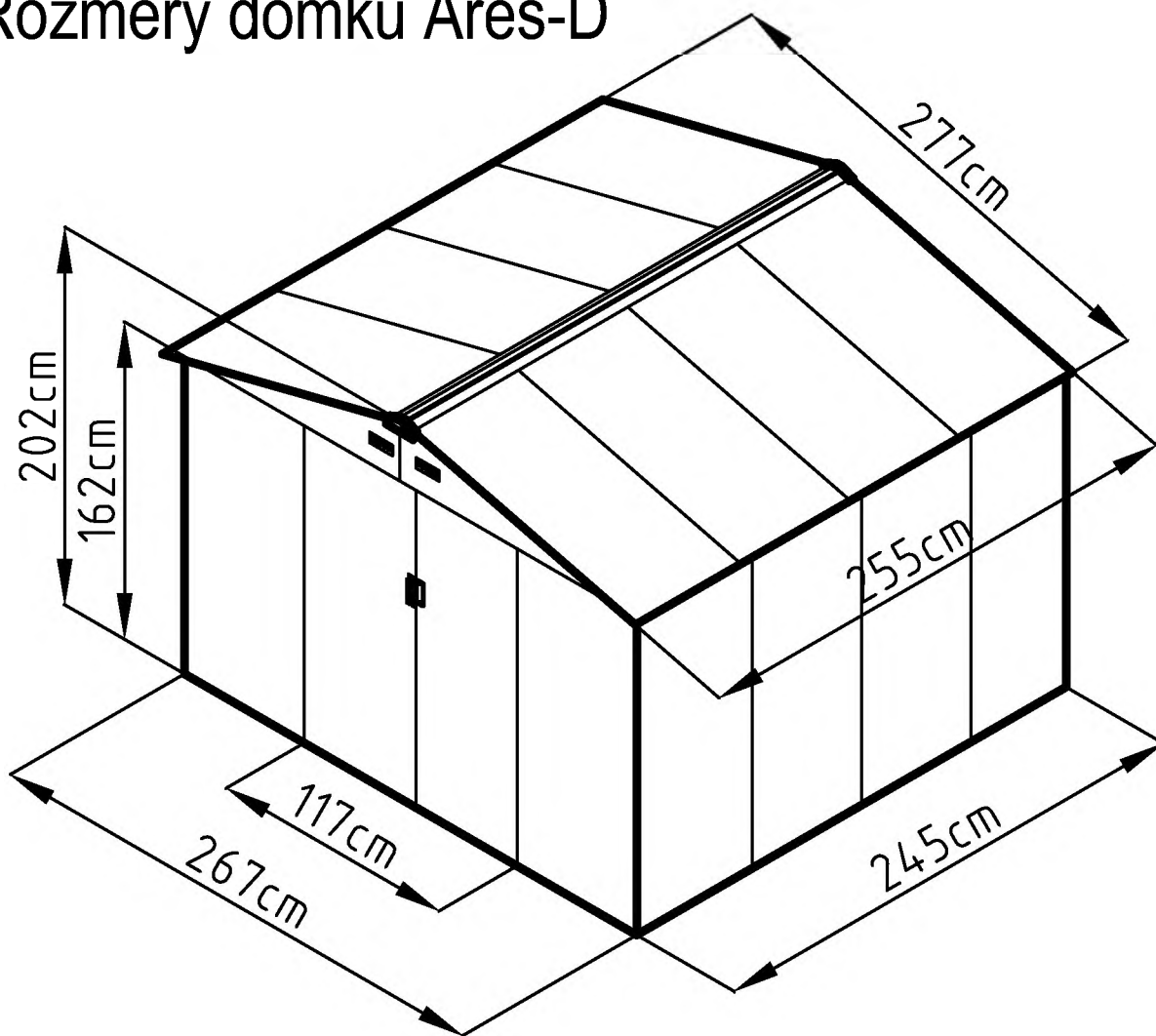

Plocha potřebná k postavení:

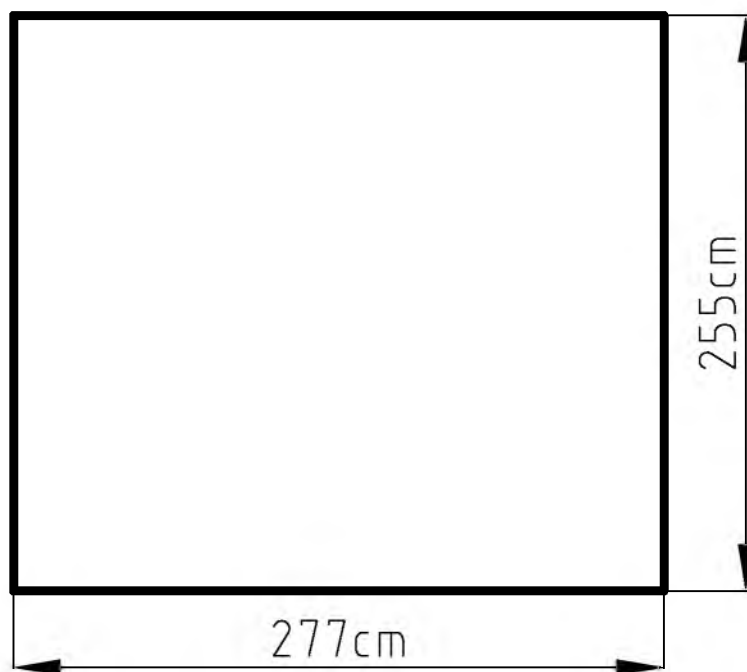

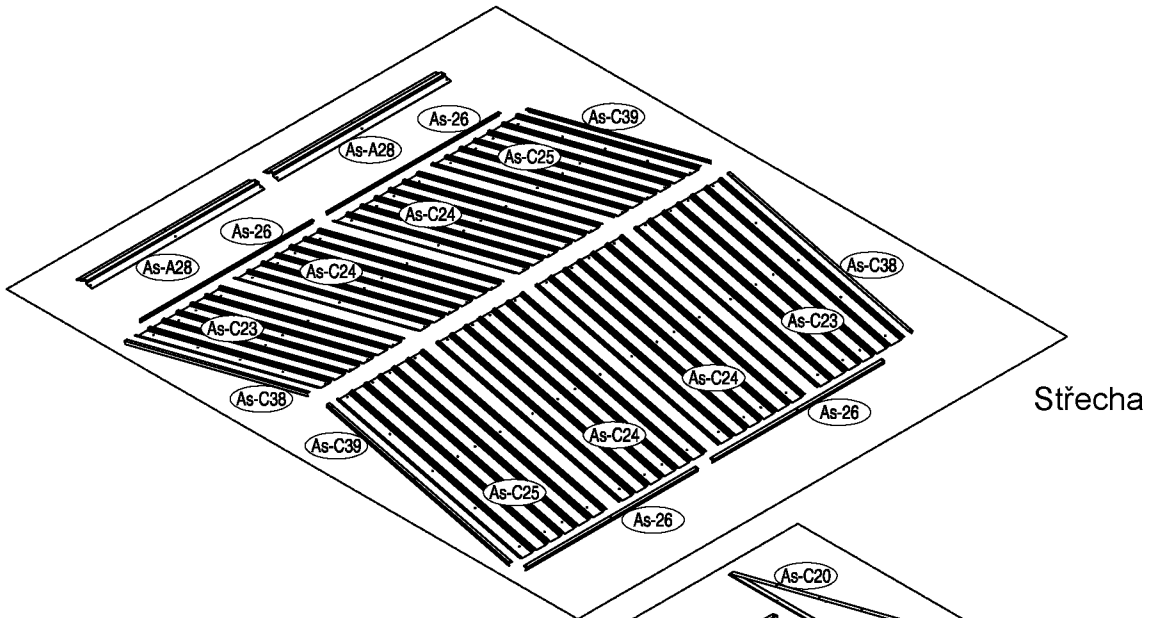

Střecha

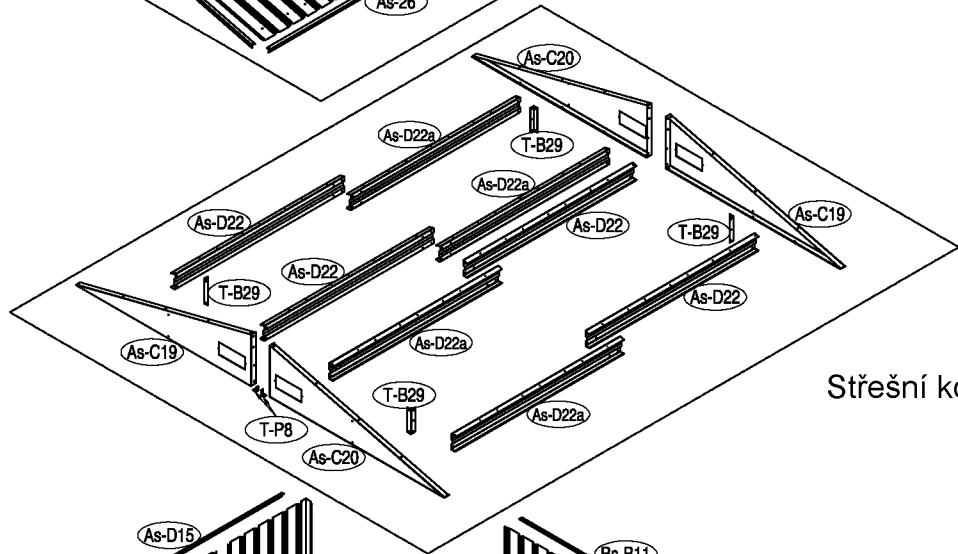

Střešní konstrukce

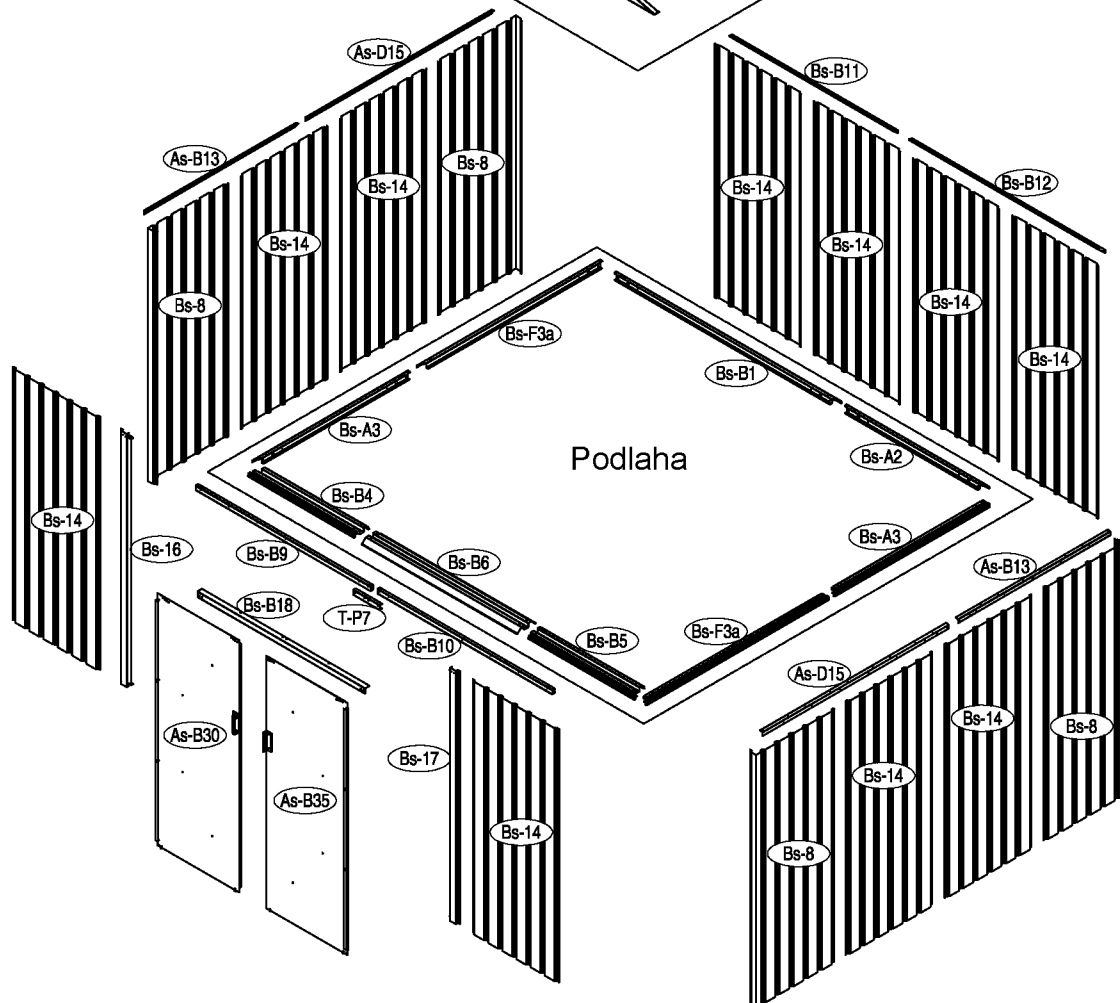

Stěny

Podlaha

1

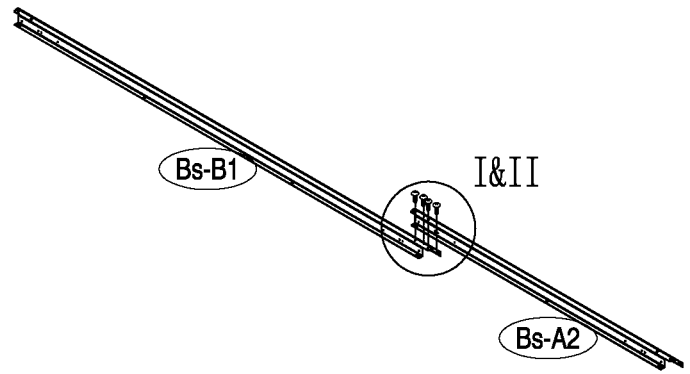
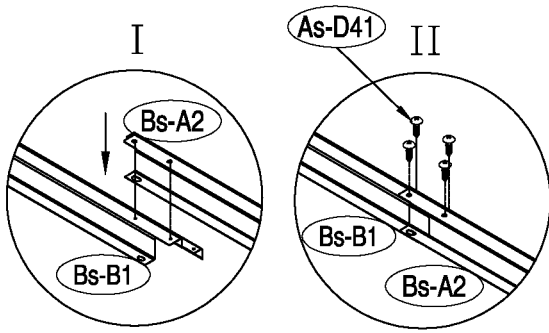

2

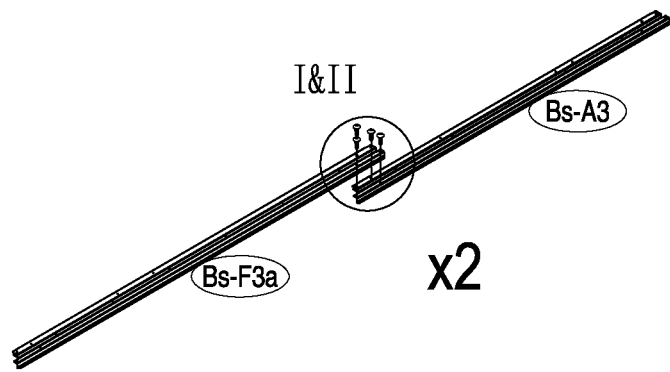
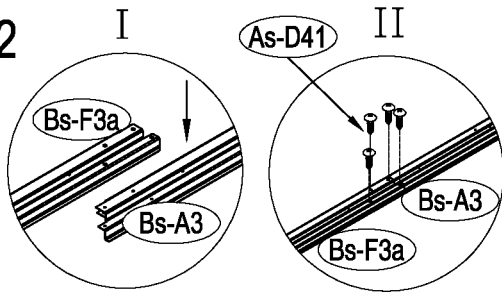

3

