

A	B	C	D	
1	S404-1008	1178	428	1/3
2	S404-1009	1178	428	1/3
3	S404-1010	388	402	1/3
4	S404-1011	388	402	1/3
5	S404-1012	693	408	1/3
6	S404-2003	1491	454	2/3
7	S404-3003	1459	428	2/3
8	S404-3004	945	407	1/3
9	S404-3005	496	407	1/3
10	S404-3006	1459	393	2/3
11	S404-4003	1459	160	2/3
12	S404-4004	1459	60	2/3
13	S404-5005	1350	70	2/3
14	S404-5006	1350	70	2/3
15	S404-5007	1178	70	1/3
16	S404-5008	1178	70	1/3
17	S404-5050	432	398	3/3
18	S404-5051	495	398	3/3
19	S404-5052	208	446	3/3
20	S404-9004	1106	509	1/3
21	S404-9303	1106	959	1/3
23	S407-0005	543	446	3/3
22	S407-0004	543	446	3/3
24	S407-0006	518	446	3/3
25	S407-0012	446	145	3/3
26	S407-0013	446	145	3/3
27	S407-0014	446	120	3/3
28	S407-0015	446	120	3/3
29	S407-0016	446	120	3/3

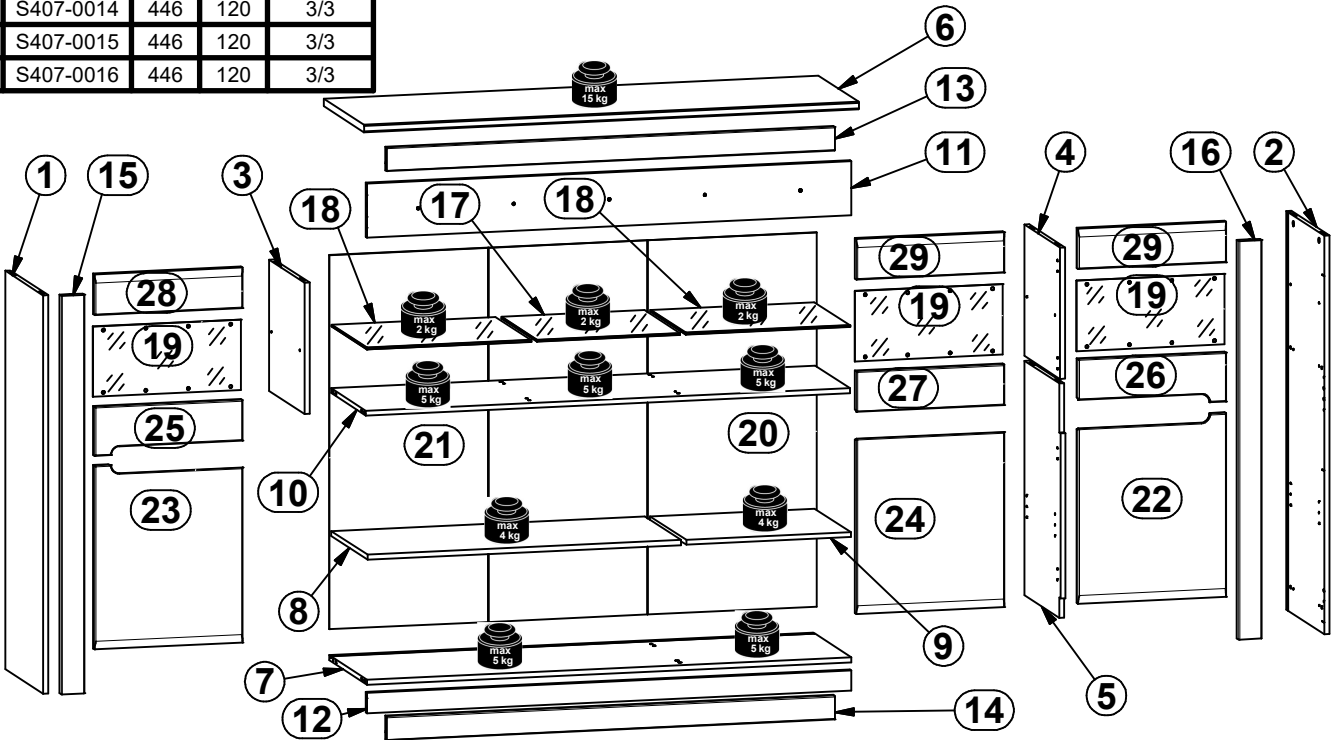

8x a132	6x a133	4x a159	12x b43	8x Ø5x17 mm d1	12x Ø5x17 mm d3	1x d36	9x d37	2x Ø7x50 mm e1
25x Ø6.3x13 mm e2	24x Ø5x12 mm e41	3x Ø7x24 mm e45	30x Ø8x30 mm f1	2x Ø8x20 mm f13	4x k1	1x 42.5x42.54 mm k38l3	1x 30x30/60 mm k38l8	12x l2
5x 22x9.5x2/0.7 mm n108	24x Ø5.3/Ø8.3x4.8 mm o54	42x Ø3.5x16 mm p38	24x Ø3.5x15 mm p51	5x Ø2.9x16 mm p55	28x Ø15x12 mm #16 r1	28x 20/11 r42	12x Ø16 s2	1x 4 mm z1
							1x n26l1	1x Ø3.5x16 mm p38

1 §2

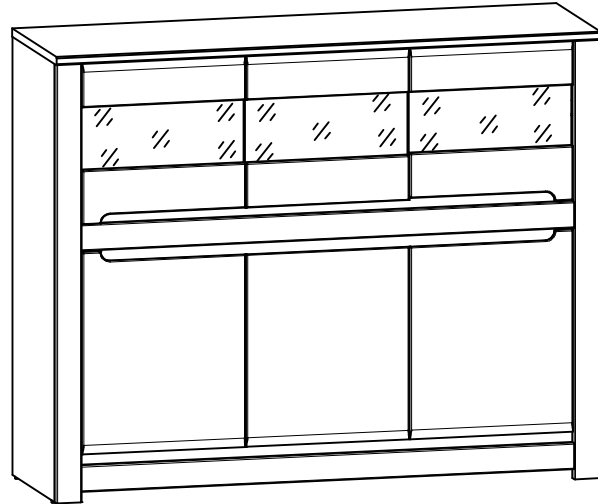
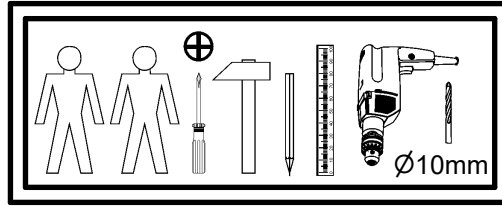
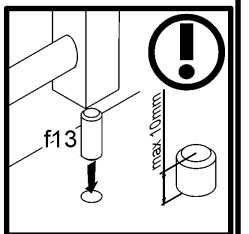
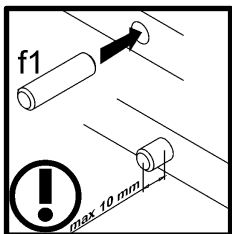
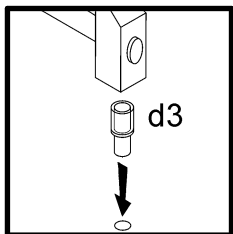
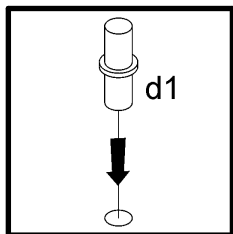
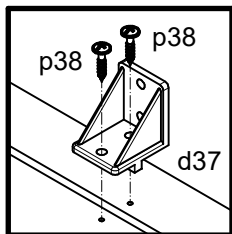
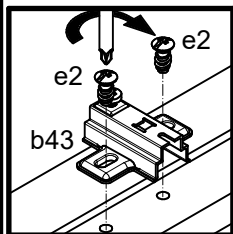
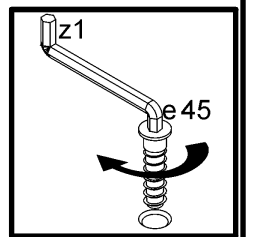
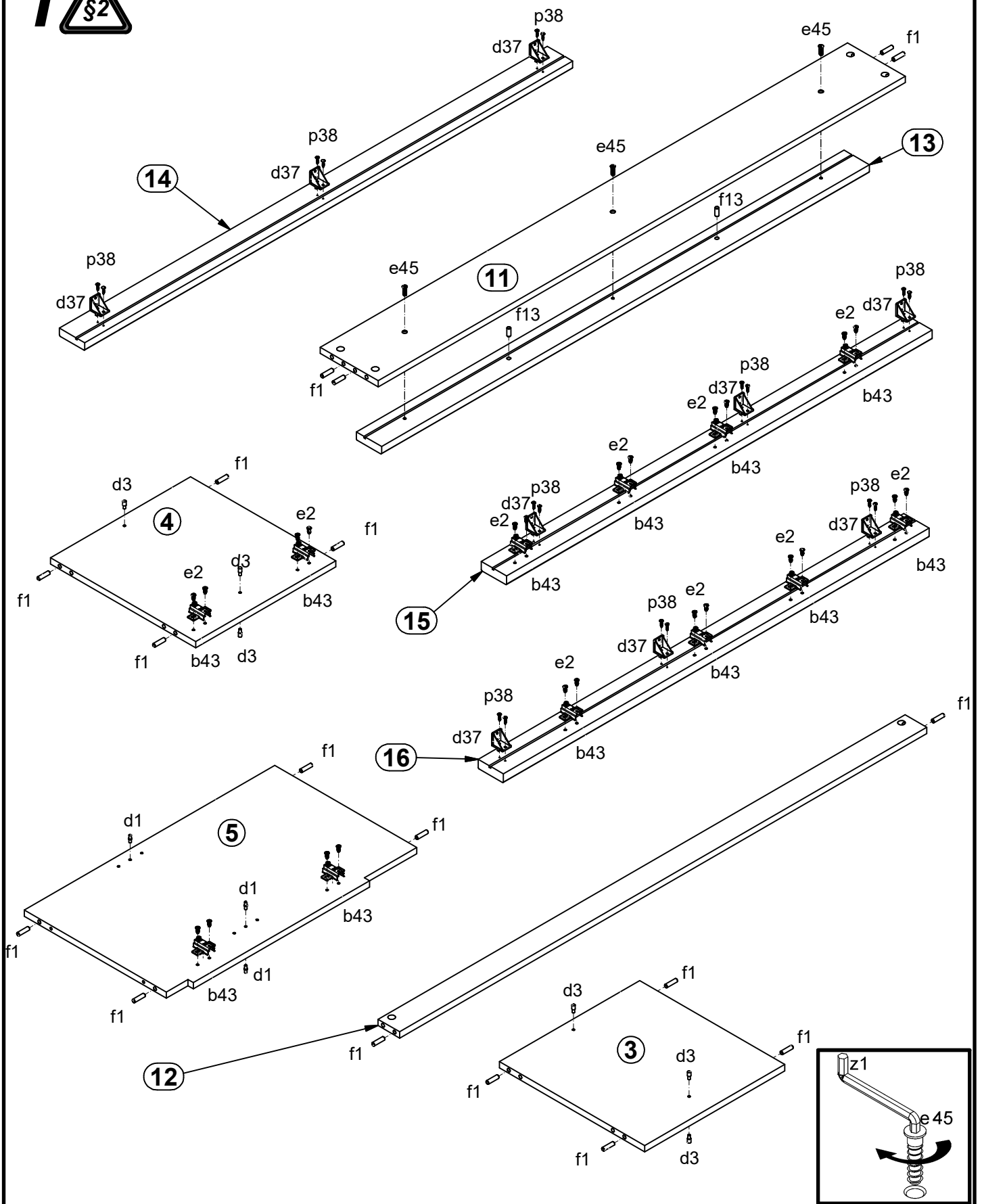

2

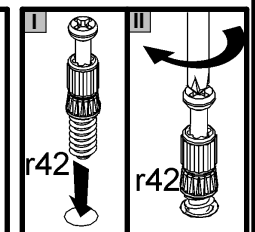
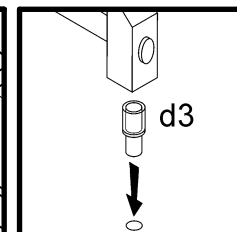
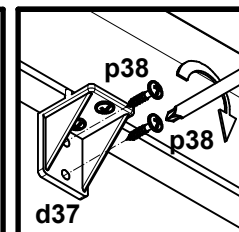
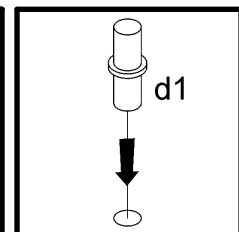
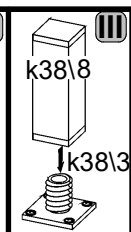
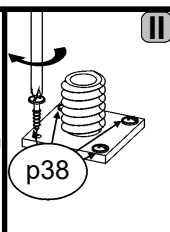
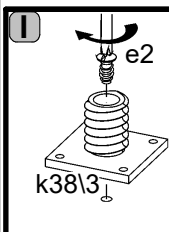
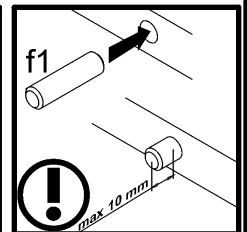
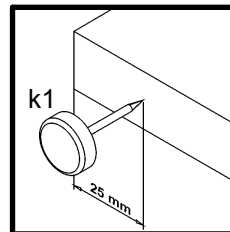
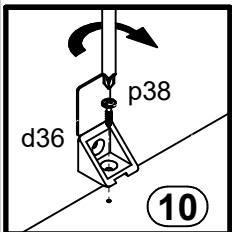
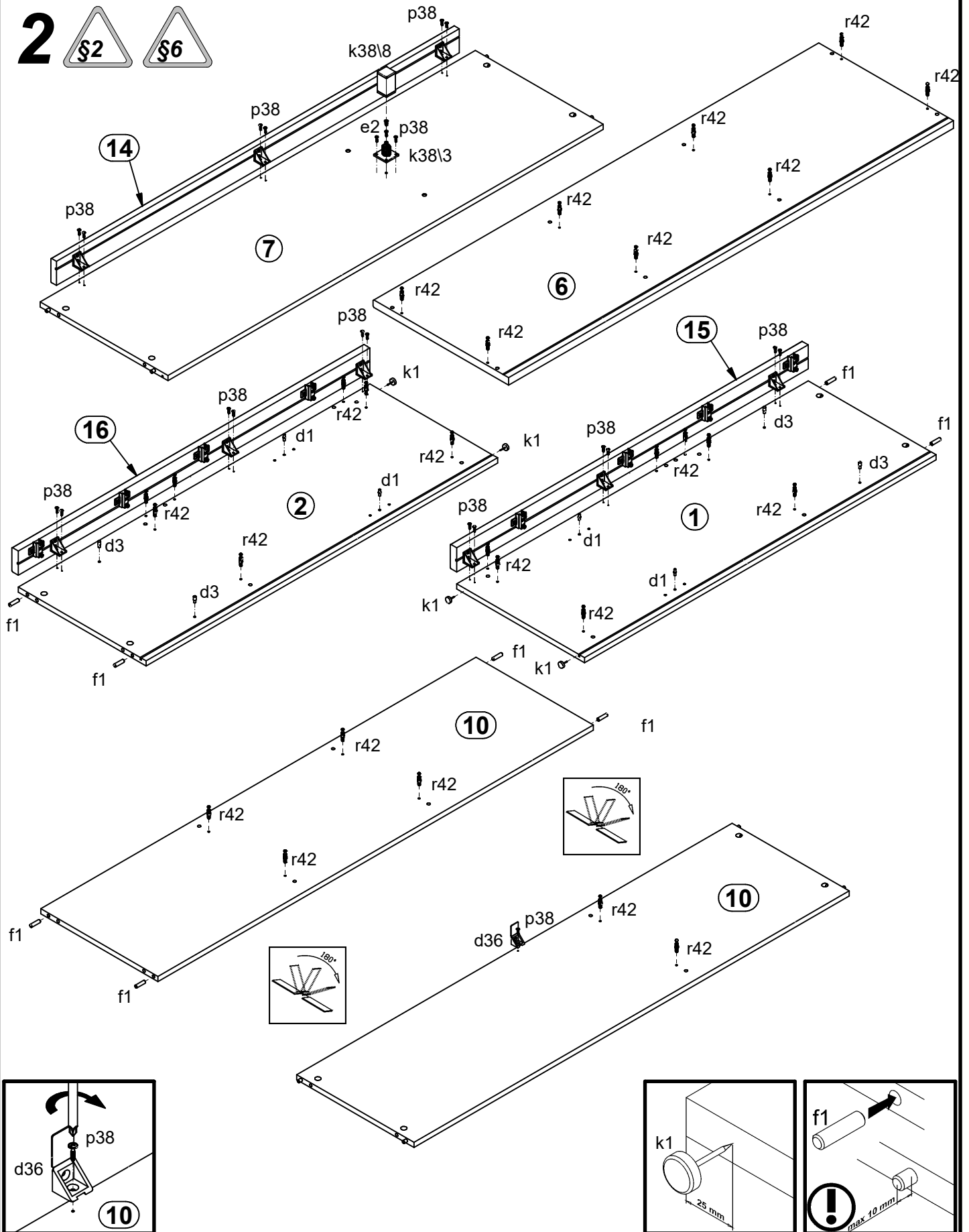

3

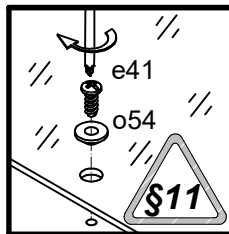
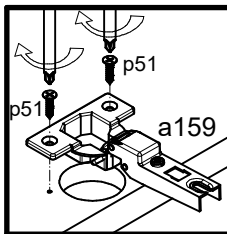
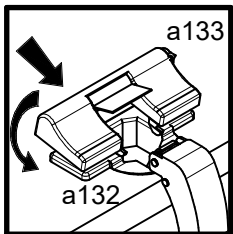
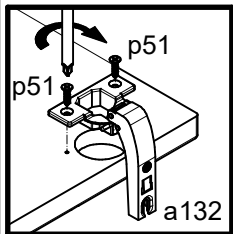
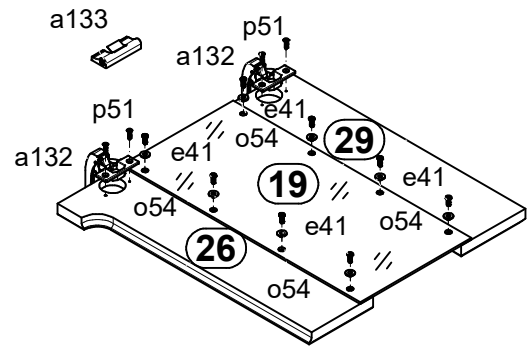
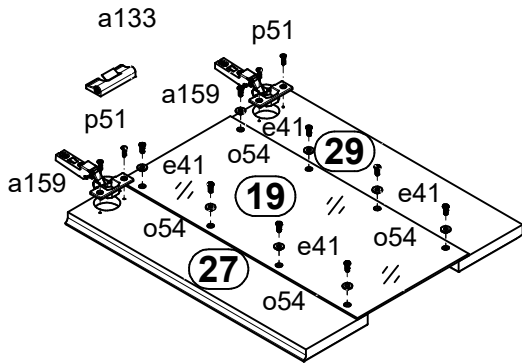
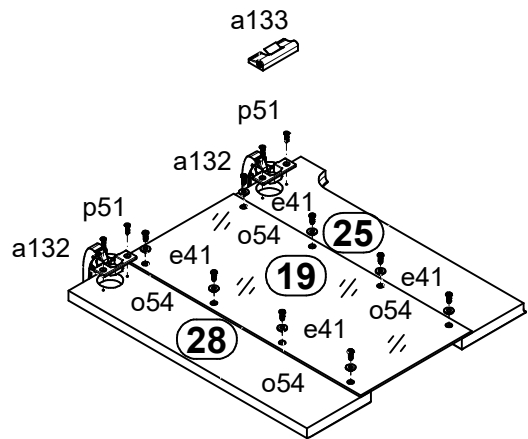
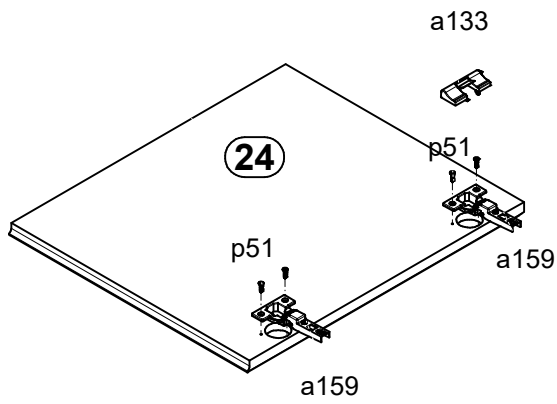
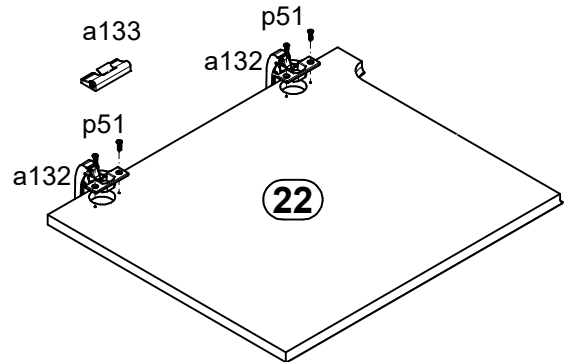
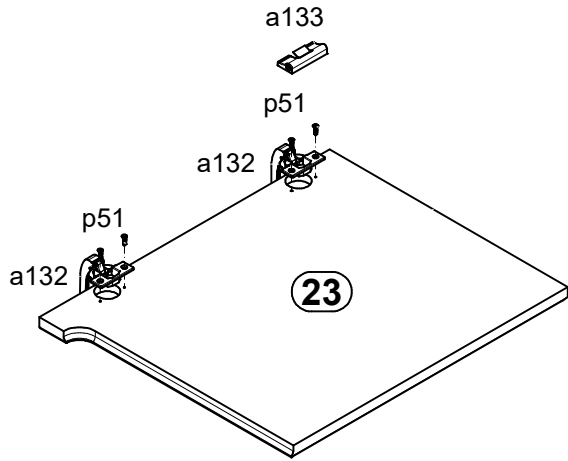

4 §6

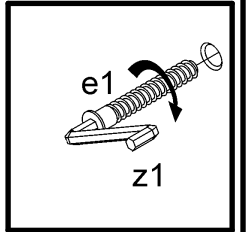
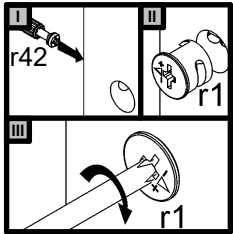
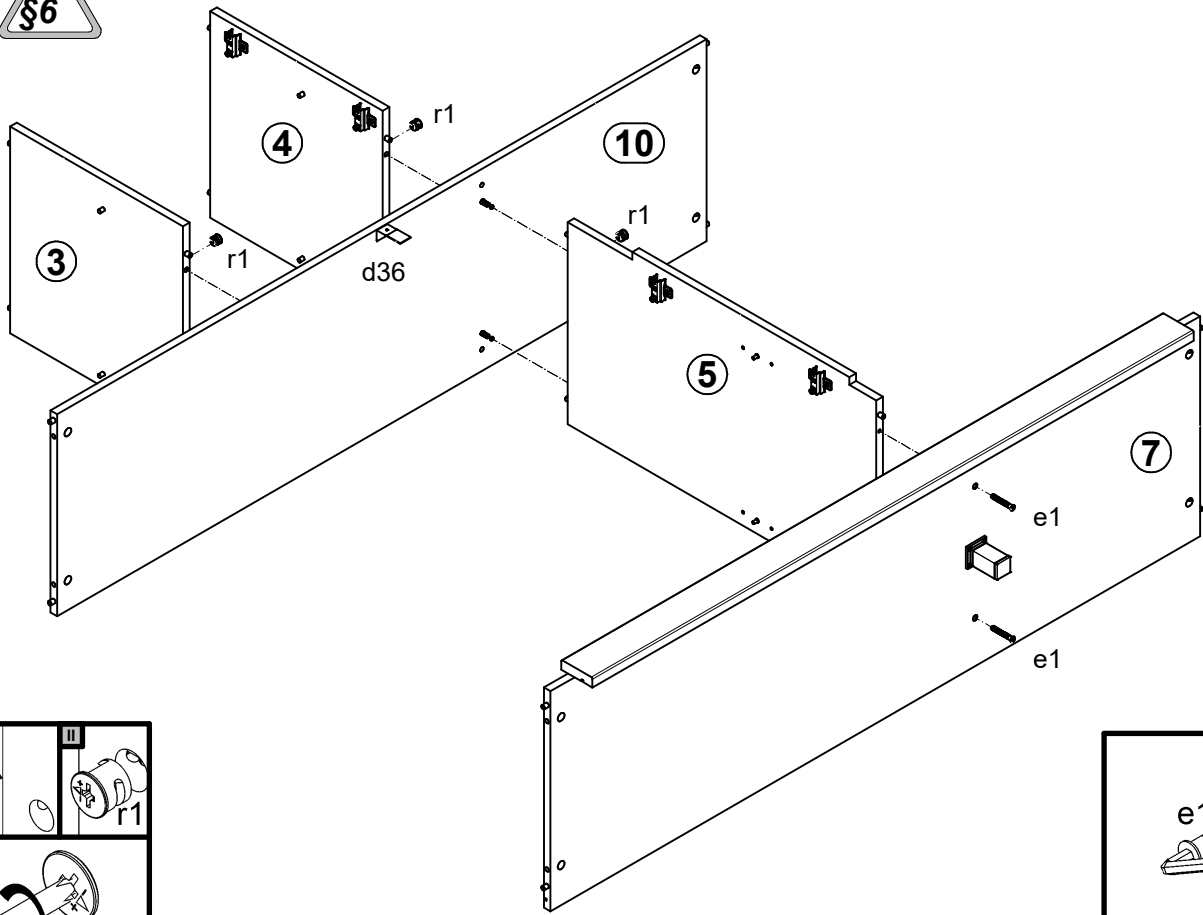

5

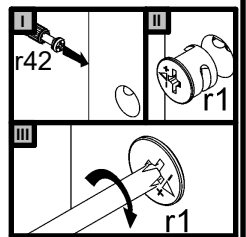
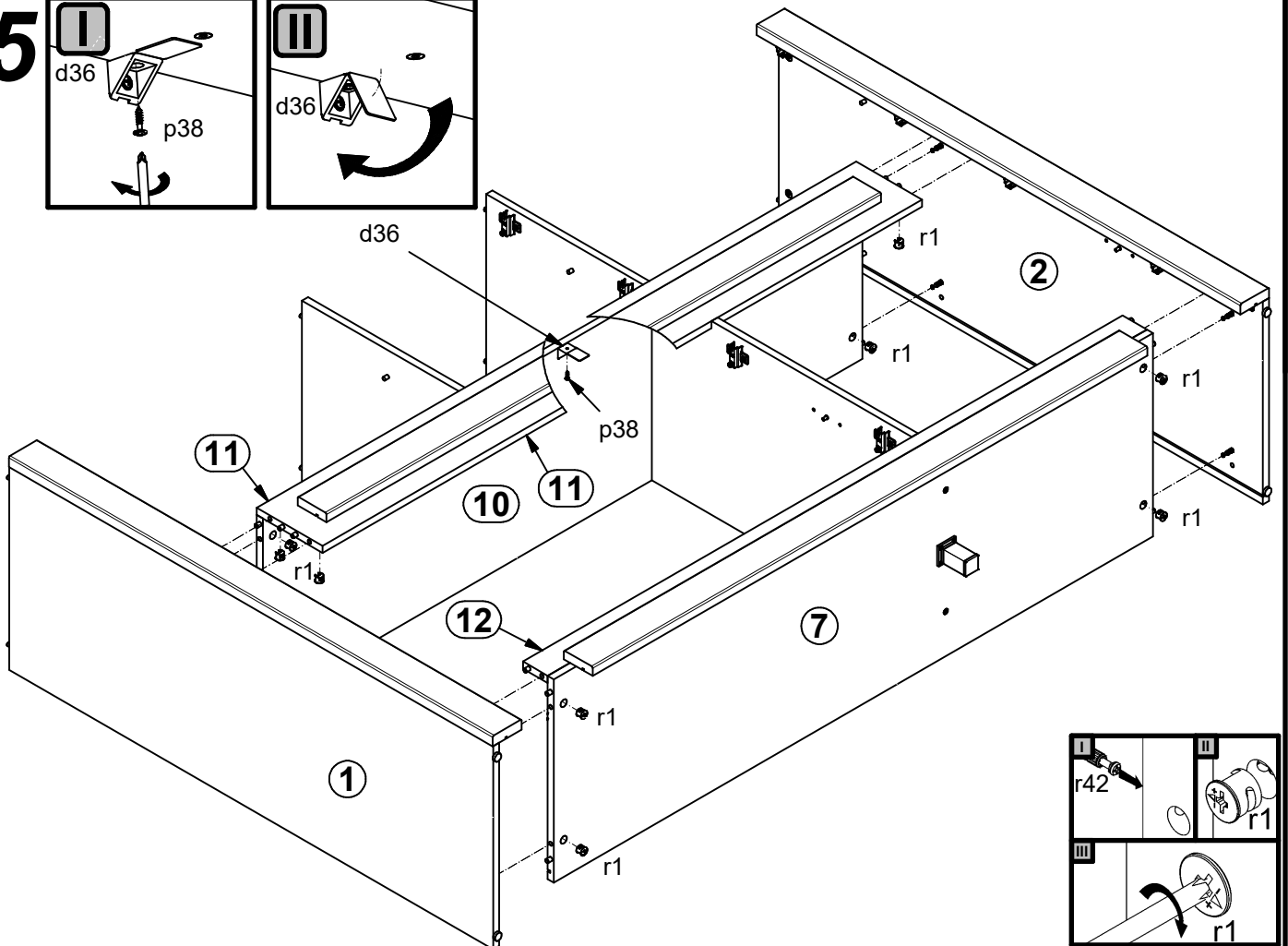
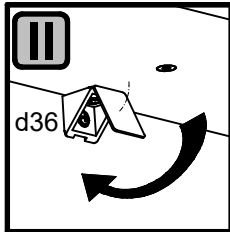
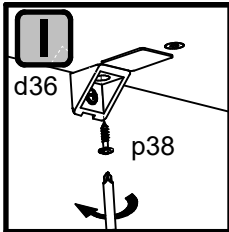

6

§6

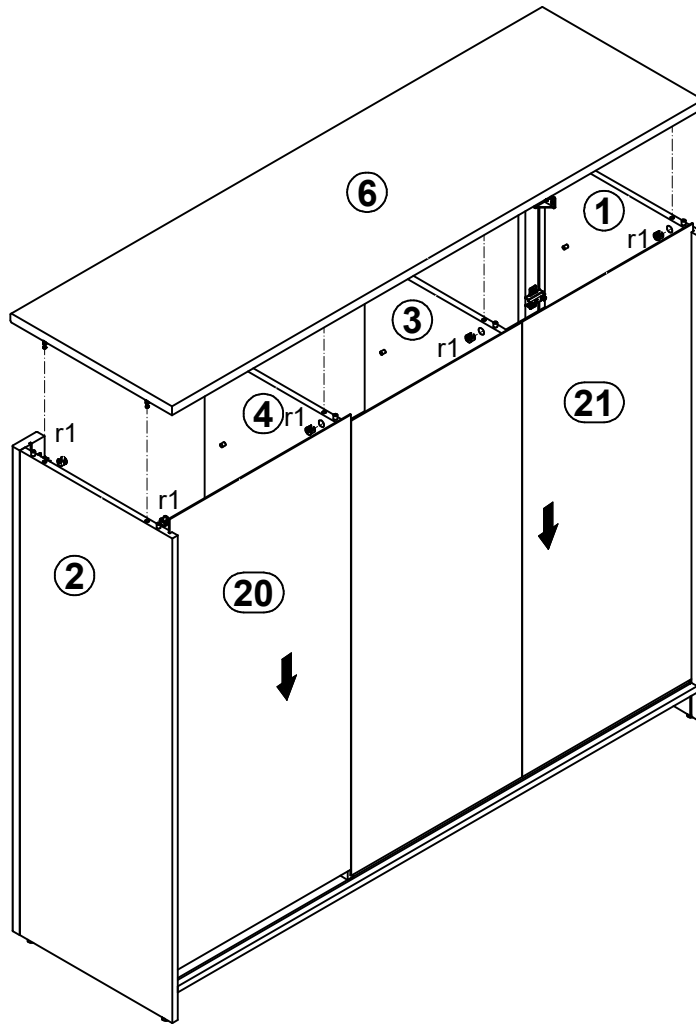

7

§6

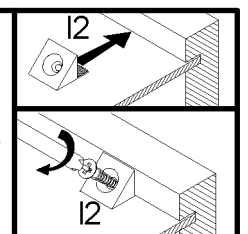
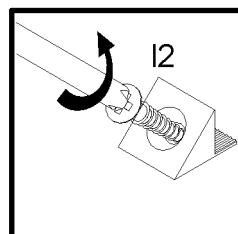
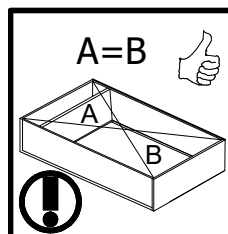
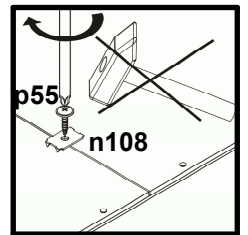
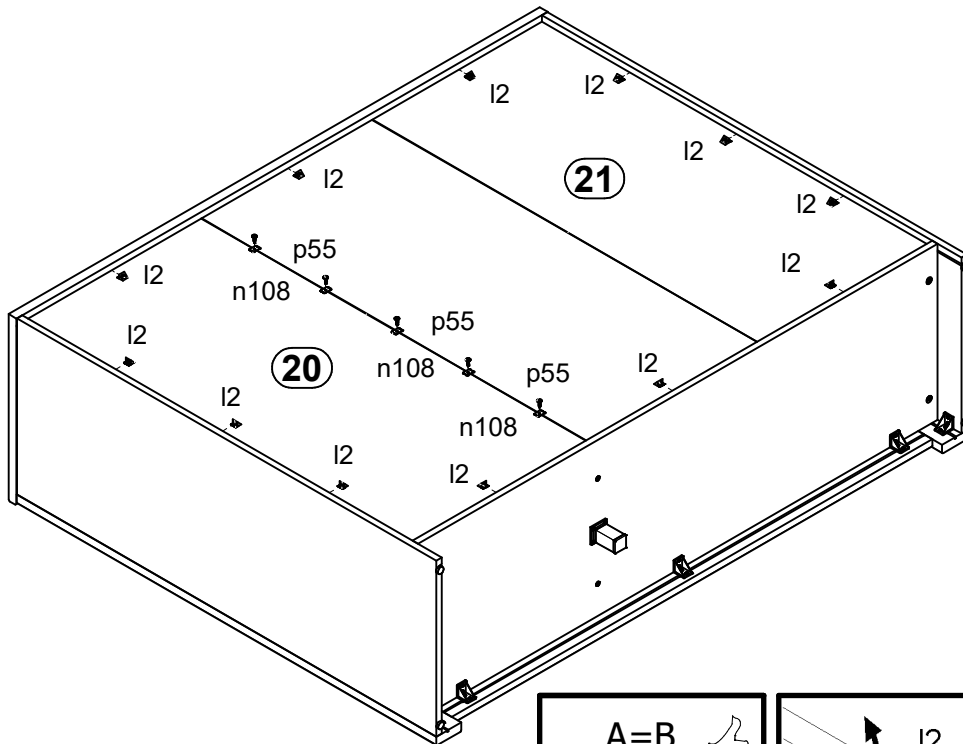

8

